

1

2

3

4

5

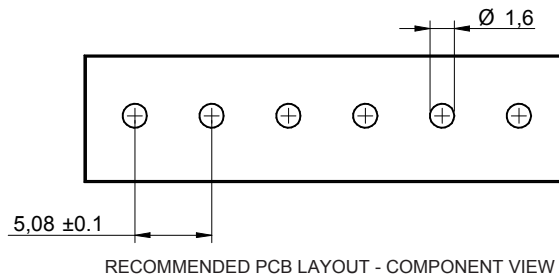

CHARACTERISTICS

MATERIAL

Insulator material : LCP
 Flammability rating : UL94-V0
 Colour : Black
 Contact pin : Brass (CuZn)
 Surface of solder tail plating : Tin Plated

ENVIRONMENTAL

Operating temperature : -40°C up to 105°C
 Compliance : Lead free and RoHS

SOLDERING

Solder temperature : Reflow process as per JEDEC J-020D-STD

ELECTRICAL

Current rating : 10A
 Working voltage : 300 Vac
 Dielectric withstanding voltage : 4 kVac/min
 Contact resistance : 20 mΩ max

STANDARD

 Certified : E315414 / Model number 7015

MECHANICAL

Pitch : 5.08mm

PACKAGING

Tape & Reel with cap

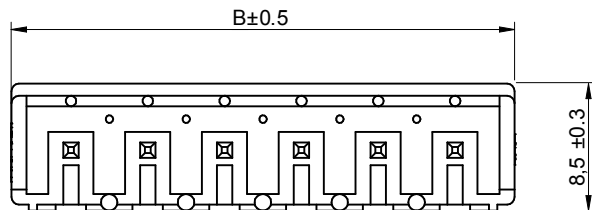

Poles	A	B
2	5.08	12.96
3	10.16	18.04
4	15.24	23.12
5	20.32	28.2
6	25.4	33.28
7	30.48	38.36
8	35.56	43.44
9	40.64	48.52
10	45.72	53.6
11	50.8	58.68
12	55.88	63.76

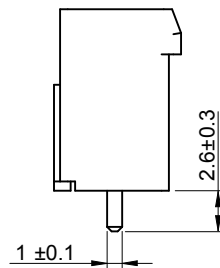
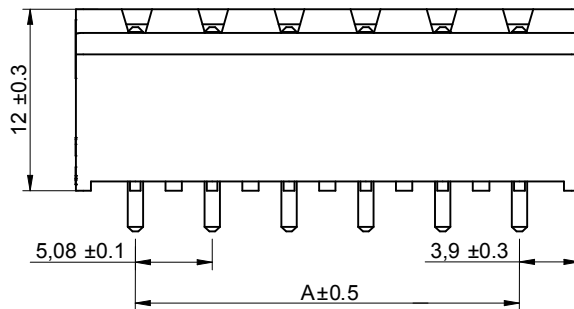

RoHS Compliant

G			
F			
E			
D			
C	29-JUL-13	DWG REVIEW	QL
B	19-DEC-11	6917015100xx	QL
A	15-SEP-11	PDF	QL
REV	DATE	FILE	BY

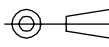
PROJECTION:	
APPROVAL: RJ	

GENERAL TOLERANCE
.X = ± 0.2
.XX = ± 0.15
UNIT: MM
SCALE: 2/1
SHEET: 1/2
DRAW: QUENTIN

 WÜRTH ELEKTRONIK	
DESCRIPTION: SERIE 7015B - 5.08MM CLOSED VERTICAL PCB HEADER - THR TYPE	SIZE
WERI PART NO: 691 701 510 0xx B	A4

A

B

C

D

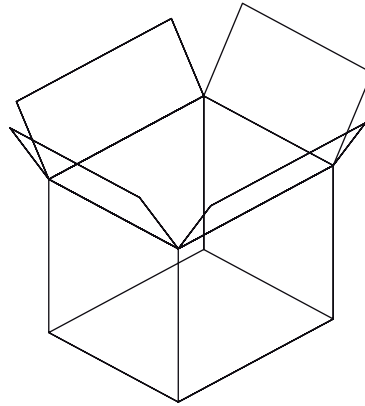
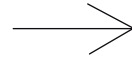
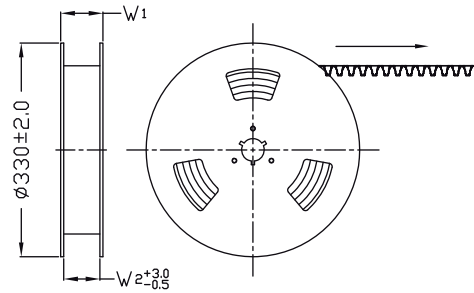

1. 10 sprocket hole pitch cumulative tolerance ± 0.20
2. Carrier camber is within 1 mm in 250 mm.
3. Material : Black Conductive Polystyrene Alloy.
Transparent anti-static PET
4. All dimensions meet EIA-481-C requirements.
5. Thickness : 0.50 ± 0.05 mm.
6. Component load per 13" reel : 150 pcs.

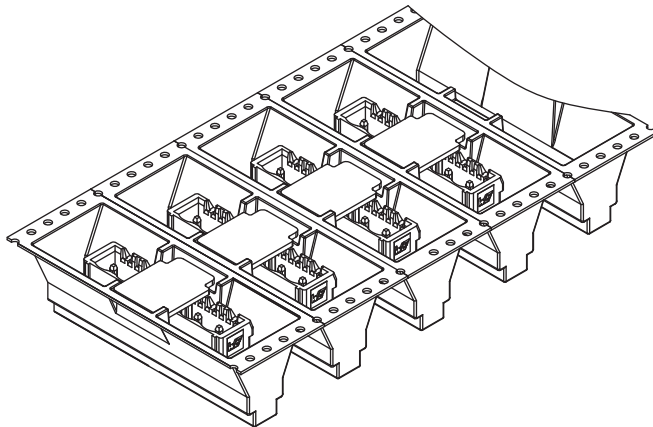
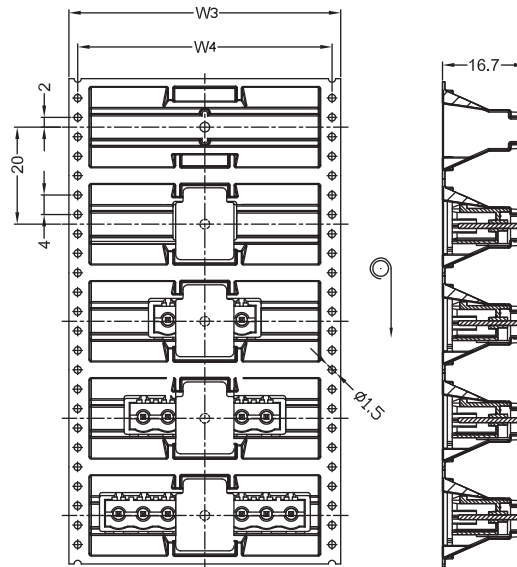
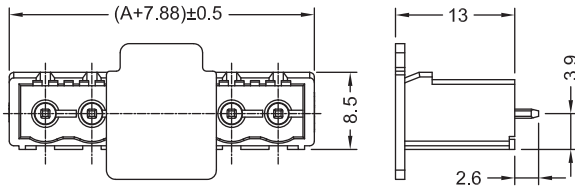

Poles	A	Dimension				Packing (Reel/coton)	Carton dimensions (cm)	Quantity / Carton
		W1(mm)	W2(mm)	W3(mm)	W4(mm)			
2	5.08	36.4	32	32	28.4	10	33.5 x 33.5 x 40	1500
3	10.16	36.4	32	32	28.4	10	33.5 x 33.5 x 40	1500
4	15.24	60.4	56	56	52.5	6	33.5 x 33.5 x 40	900
5	20.32	60.4	56	56	52.5	6	33.5 x 33.5 x 40	900
6	25.40	60.4	56	56	52.5	6	33.5 x 33.5 x 40	900
7	30.48	60.4	56	56	52.5	6	33.5 x 33.5 x 40	900
8	35.56	60.4	56	56	52.5	6	33.5 x 33.5 x 40	900
9	40.64	92.4	88	88	84.4	4	33.5 x 33.5 x 40	600
10	45.72	92.4	88	88	84.4	4	33.5 x 33.5 x 40	600
11	50.80	92.4	88	88	84.4	4	33.5 x 33.5 x 40	600
12	55.88	92.4	88	88	84.4	4	33.5 x 33.5 x 40	600

RoHS Compliant			
G			
F			
E			
D			
C			
B			
A			
REV	DATE	FILE	BY

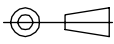
PROJECTION:

 APPROVAL: RJ

GENERAL TOLERANCE
 .X = ± 0.2
 .XX = ± 0.15
 UNIT: MM
 SCALE:
 SHEET: 2/2
 DRAW: QUENTIN



DESCRIPTION: SERIE 7015B - 5.08MM CLOSED VERTICAL PCB HEADER - THR TYPE
 WERI PART NO: 691 701 510 0xx B

SIZE
A4