



# Product Specification

G270ZAN01.5

AU OPTRONICS CORPORATION

( v ) Preliminary Specifications

( ) Final Specifications

<b>Module</b>	27.0 Inch Color TFT-LCD
<b>Model Name</b>	G270ZAN01.5

<b>Customer</b>	<b>Date</b>
_____	_____
<b>Checked &amp; Approved by</b>	<b>Date</b>
_____	_____
Customer's sign back page	

<b>Approved by</b>	<b>Date</b>
<i>Jason Pan</i>	_____ 2018. 11. 20
<b>Prepared by</b>	<b>Date</b>
<i>HsinYin Lee</i>	_____ 2018. 11. 20
General Display Business Division / AU Optronics corporation	



## Contents

<b>1. Operating Precautions</b>	<b>4</b>
<b>2. General Description</b>	<b>5</b>
2.1 Display Characteristics	5
2.2 Optical Characteristics	6
<b>3. Functional Block Diagram</b>	<b>9</b>
<b>4. Absolute Maximum Ratings</b>	<b>10</b>
4.1 Absolute Ratings of TFT LCD Module	10
4.2 Absolute Ratings of Environment	10
<b>5. Electrical Characteristics</b>	<b>11</b>
5.1 TFT LCD Module	11
5.2 Backlight Unit	13
<b>6. Signal Characteristic</b>	<b>15</b>
6.1 Pixel Format Image	15
6.2 Scanning Direction	15
6.3 Signal Description	16
6.4 The Input Data Format	19
6.5 Interface Timing	21
6.6 Power ON/OFF Sequence	22
<b>7. Reliability Test Criteria</b>	<b>23</b>
<b>8. Mechanical Characteristics</b>	<b>25</b>
8.1 LCM Outline Dimension	25
<b>9. Label and Packaging</b>	<b>27</b>
9.1 Shipping Label (on the rear side of TFT-LCD display)	27
9.2 Carton Package	28
<b>10 Safety</b>	<b>29</b>
10.1 Sharp Edge Requirements	29
10.2 Materials	29
10.3 Capacitors	29
10.4 National Test Lab Requirement	29



## 1. Operating Precautions

- 1) Since front polarizer is easily damaged, please be cautious and not to scratch it.
- 2) Be sure to turn off power supply when inserting or disconnecting from input connector.
- 3) Wipe off water drop immediately. Long contact with water may cause discoloration or spots.
- 4) When the panel surface is soiled, wipe it with absorbent cotton or soft cloth.
- 5) Since the panel is made of glass, it may be broken or cracked if dropped or bumped on hard surface.
- 6) To avoid ESD (Electro Static Discharge) damage, be sure to ground yourself before handling TFT-LCD Module.
- 7) Do not open nor modify the module assembly.
- 8) Do not press the reflector sheet at the back of the module to any direction.
- 9) In case if a module has to be put back into the packing container slot after it was taken out from the container, do not press the center of the LED light bar edge. Instead, press at the far ends of the LED light bar edge softly. Otherwise the TFT Module may be damaged.
- 10) At the insertion or removal of the Signal Interface Connector, be sure not to rotate nor tilt the Interface Connector of the TFT Module.
- 11) TFT-LCD Module is not allowed to be twisted & bent even force is added on module in a very short time. Please design your display product well to avoid external force applying to module by end-user directly.
- 12) Small amount of materials having no flammability grade is used in the LCD module. The LCD module should be supplied by power complied with requirements of Limited Power Source (IEC60950 or UL1950), or be applied exemption.
- 13) Severe temperature condition may result in different luminance, response time and lamp ignition voltage.
- 14) Continuous operating TFT-LCD display under low temperature environment may accelerate lamp exhaustion and reduce luminance dramatically.
- 15) The data on this specification sheet is applicable when LCD module is placed in landscape position.
- 16) Continuous displaying fixed pattern may induce image sticking. It's recommended to use screen saver or shuffle content periodically if fixed pattern is displayed on the screen.

## 2. General Description

This specification applies to the 27 inch wide color a-Si TFT-LCD module G270ZAN01.5. The screen format is intended to support the UHD (3840(H) x 2160(V)) screen and 1.07B colors. The input interface is 4lanes eDP and this module doesn't contain driver board for backlight.

### 2.1 Display Characteristics

The following items are characteristics summary on the table under 25 °C condition:

Items	Unit	Specifications
Screen Diagonal	[inch]	26.93" (684mm)
Active Area	[mm]	596.16 (H) x 335.34 (V)
Resolution		3840(x3) x 2160
Pixel Pitch	[mm]	0.15525 (per one triad) x 0.15525
Pixel Arrangement		R.G.B. Vertical Stripe
Display Mode		AHVA mode, Normally Black
Nominal Input Voltage VDD	[Volt]	+12V (Typ)
Power Consumption	[Watt]	Total =35.9W (Typ) LCD 10.8W @ white pattern, Fv=60Hz BLU 25.1W @ Is=95mA
Color gamut		NTSC 93% (Typ)
Weight	[Grams]	3300 (Typ)
Physical Size	[mm]	613.6(H) x 356.85(V) x 14.4(D) (Typ)
Electrical Interface		4-lanes eDP , 10bits RGB data input
Surface Treatment		Anti-Glare treatment, 3H
Support Color		1.07B colors (8bit + Hi-FRC)
Temperature Range		
Operating	[°C]	0 to +50
Storage (Non-Operating)	[°C]	-20 to +60
RoHS Compliance		

## 2.2 Optical Characteristics

The optical characteristics are measured under stable conditions at 25 °C (Room Temperature):

Item	Unit	Conditions	Min.	Typ.	Max.	Note	
White Luminance	cd/m <sup>2</sup>	I <sub>LED</sub> =95mA(center point)	320	400	-	1	
Uniformity	%	9 points	75	80	-	2,3	
Contrast Ratio	--		700	1000	-	4	
Response Time	msec	Rising	-	-	-	5	
		Falling	-	-	-		
		Rising + Falling	-	16	25		
Viewing Angle	degree	Horizontal CR >= 10	(Right)	75	89	-	6
			(Left)	75	89	-	
		Vertical CR >= 10	(Upper)	70	89	-	
			(Lower)	70	89	-	
Color / Chromaticity Coordinates (CIE 1931)	--	Red x	0.653	0.683	0.713		
		Red y	0.272	0.302	0.332		
		Green x	0.239	0.269	0.299		
		Green y	0.625	0.655	0.685		
		Blue x	0.119	0.149	0.179		
		Blue y	0.012	0.042	0.072		
		White x	0.283	0.313	0.343		
		White y	0.299	0.329	0.359		

Note 1: Measurement method

Equipment Pattern Generator, Power Supply, Digital Voltmeter, Luminance meter (SR\_3 or equivalent)

Aperture 1φ with 50cm viewing distance

Test Point Center

Environment < 1 lux

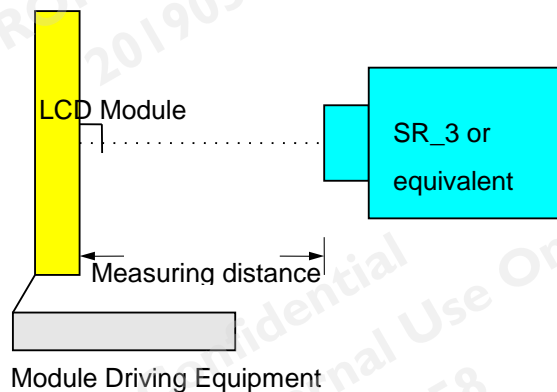

Note 2: Definition of 9 points position

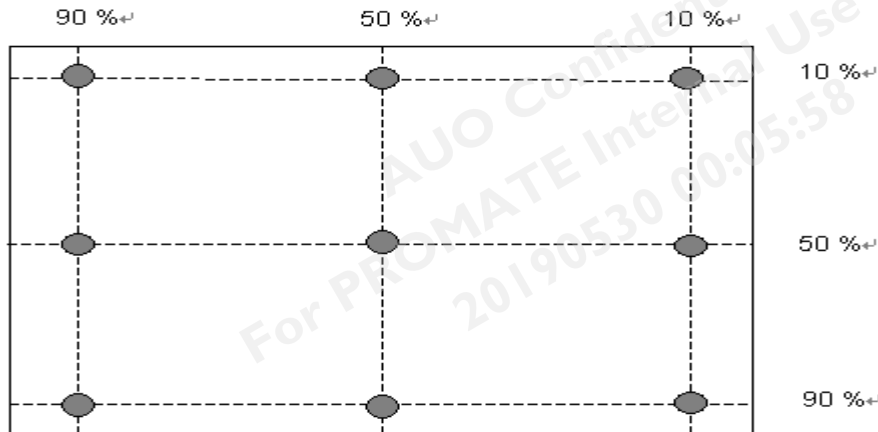

Note 3: The luminance uniformity of 9 points is defined by dividing the minimum luminance values by the maximum test point luminance

$$\delta_{w9} = \frac{\text{Minimum Brightness of nine points}}{\text{Maximum Brightness of nine points}}$$

Note 4: Definition of contrast ratio (CR):

$$\text{Contrast ratio (CR)} = \frac{\text{Brightness on the "White" state}}{\text{Brightness on the "Black" state}}$$

Note 5: Definition of response time:

The output signals of photo detector are measured when the input signals are changed from "White" to "Black" (falling time) and from "Black" to "White" (rising time), respectively. The response time interval is between 10% and 90% of amplitudes. Please refer to the figure as below.

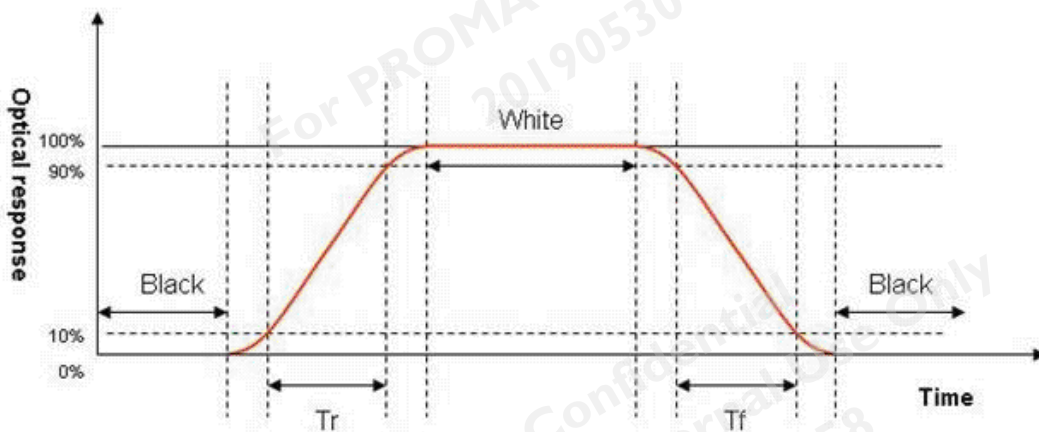

**Note 6: Definition of viewing angle**

Viewing angle is the measurement of contrast ratio  $\geq 10$ , at the screen center, over a  $180^\circ$  horizontal and  $180^\circ$  vertical range (off-normal viewing angles). The  $180^\circ$  viewing angle range is broken down as below:  $90^\circ$  ( $\theta$ ) horizontal left and right, and  $90^\circ$  ( $\phi$ ) vertical high (up) and low (down). The measurement direction is typically perpendicular to the display surface with the screen rotated to its center to develop the desired measurement viewing angle.

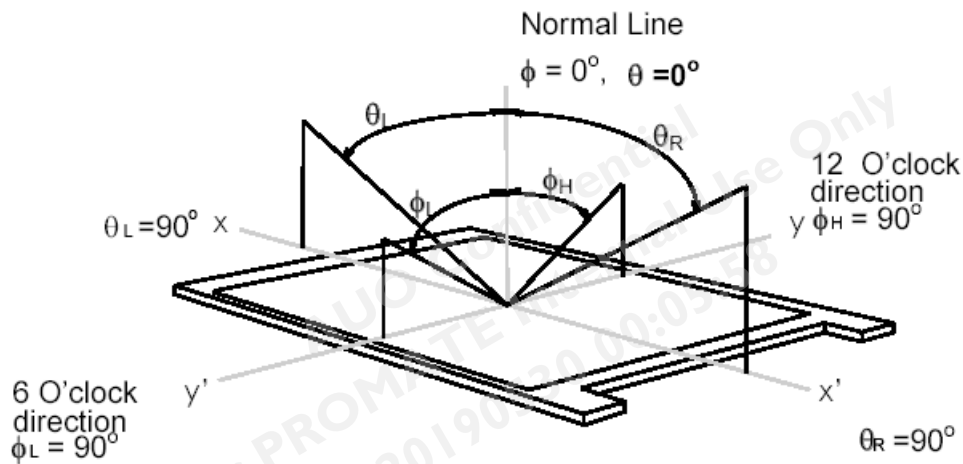



## 3. Functional Block Diagram

The following diagram shows the functional block of the 27.0 inch color TFT/LCD module:

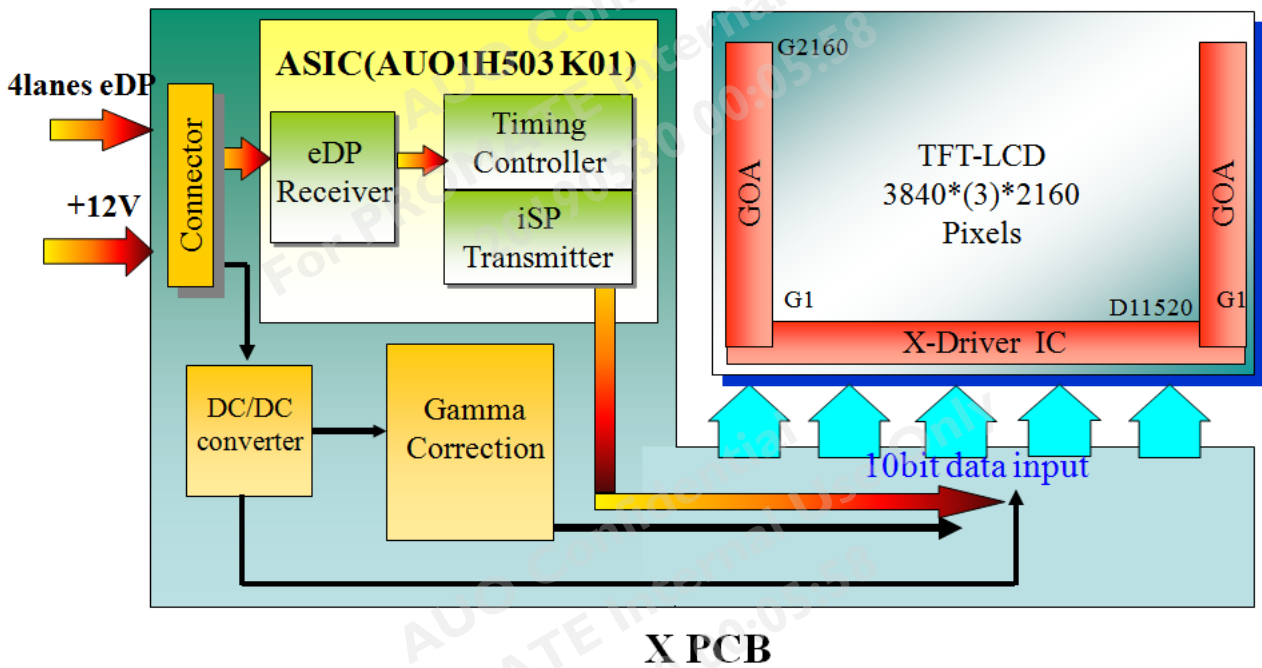

AUO Confidential  
 For PROMATE Internal Use Only  
 20190530 00:05:58

## 4. Absolute Maximum Ratings

### 4.1 Absolute Ratings of TFT LCD Module

Item	Symbol	Min	Max	Unit
Logic/LCD drive Voltage	Vin	GND-0.3	14	[Volt]

### 4.2 Absolute Ratings of Environment

Item	Symbol	Min	Max	Unit
Operating Temperature	TOP	0	+50	[°C]
Operation Humidity	HOP	5	90	[%RH]
Storage Temperature	TST	-20	+60	[°C]
Storage Humidity	HST	5	90	[%RH]

Note: Maximum Wet-Bulb should be 39°C and no condensation.

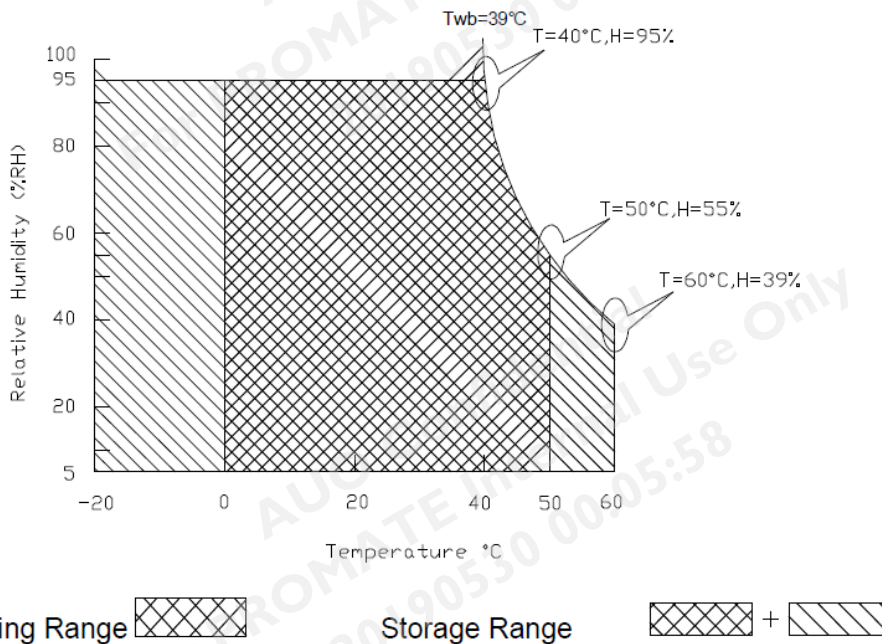

## 5. Electrical Characteristics

### 5.1 TFT LCD Module

#### 5.1.1 Power Specification

Input power specifications are shown as follows;

Symbol	Parameter	Min	Typ	Max	Units	Remark
VDD	Power supply Input voltage	10.8	12.0	13.2	[Volt]	
IDD	Power supply Input Current (RMS)	-	0.90	1.08	[A]	VDD= 12.0V, White pattern, Fv=60Hz
IRush	Inrush Current	-	-	3.0	[A]	<b>Note 1</b>
PDD	VDD Power Consumption	-	10.8	11.88	[Watt]	VDD= 12.0V, White pattern, Fv=60Hz
VDDrp	Allowable VDD Ripple Voltage	-	-	VDD* 5%	[mV]	VDD= 12.0V, White pattern, Fv=60Hz

**Note 1:** Measurement condition:

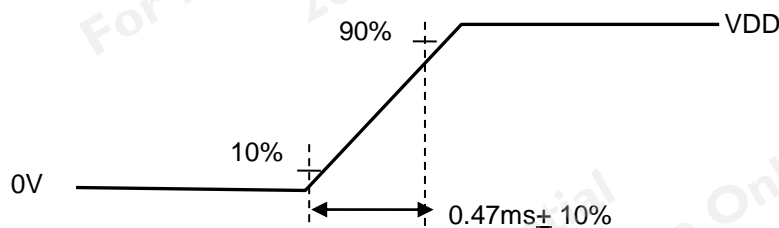
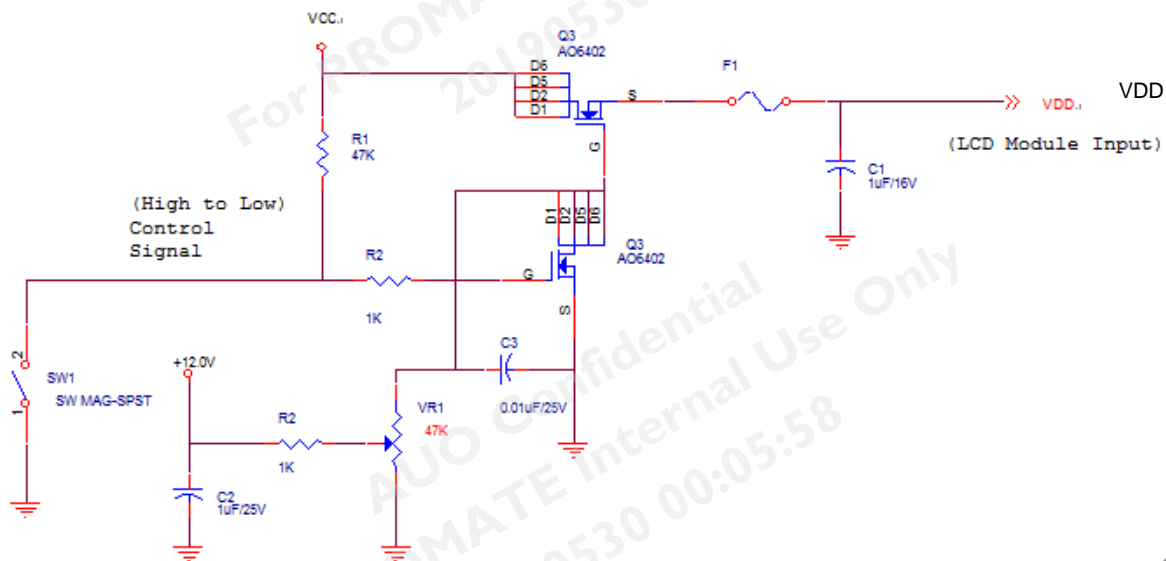

VDD rising time

## 5.1.2 eDP Electrical Characteristics

Follow as VESA Display Port Standard Version 1.2

a. Display Port main link signal:

DisplayPort main link					
		Min	Typ	Max	unit
VCM	RX input DC Common Mode Voltage	0	-	2.0	V
VDiff <sub>P-P</sub>	Peak-to-peak Voltage at a receiving Device	150	-	-	mV

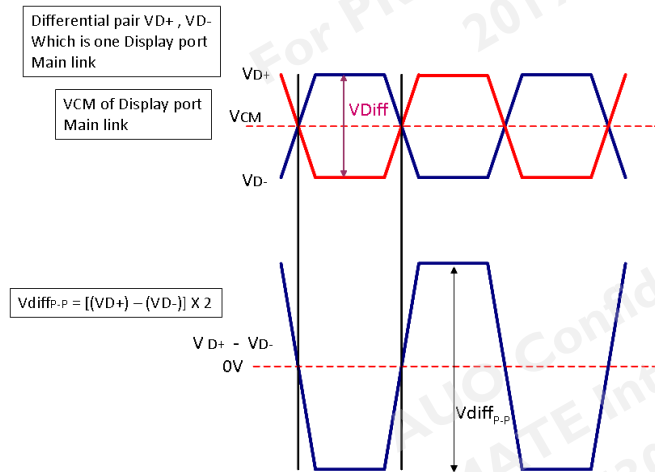

b. DisplayPort AUX\_CH signal:

DisplayPort AUX_CH					
		Min	Typ	Max	unit
VCM	AUX DC Common Mode Voltage	0	-	2.0	V
VDiff <sub>P-P</sub>	AUX Peak-to-peak voltage at a receiving device	0.27	-	1.36	V

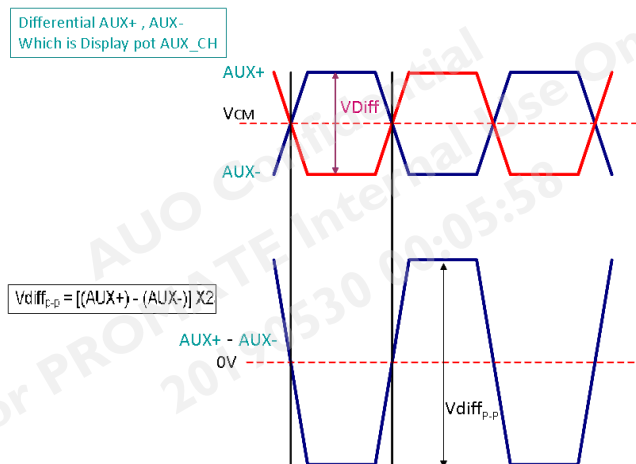

c. DisplayPort VHPD signal:

DisplayPort VHPD					
		Min	Typ	Max	unit
VHPD	HPD Voltage	2.25	-	3.6	V

## 5.2 Backlight Unit

### 5.2.1 LED Backlight Unit : Light bar Connector

Connector Name / Designation	Lamp Connector
Manufacturer	ENTERY
Backlight connector	3709K-Q06C-04L 6PIN
Mating connector	H112K-D06N-31,33B

### 5.2.2 Connector Pin Assignment

CN1 & CN2

Pin #	Symbol	Description
1	Ch1	IRLED (current out)
2	Ch2	IRLED (current out)
3	V <sub>SLED</sub>	VLED (voltage in))
4	V <sub>SLED</sub>	VLED (voltage in)
5	Ch3	IRLED (current out)
6	Ch4	IRLED (current out)

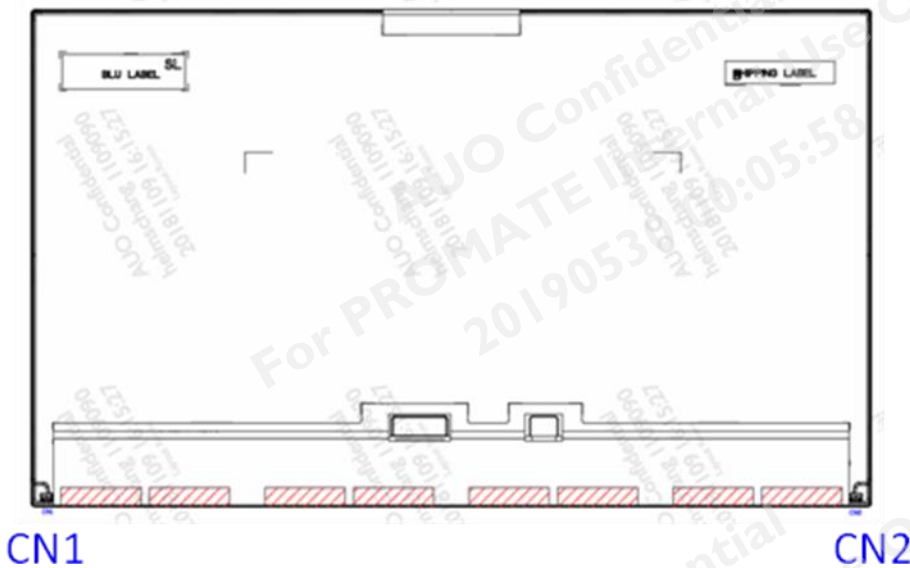

## 5.2.3 Parameter guideline for LED

Following characteristics are measured under a stable condition using an inverter at 25°C (Room Temperature):

Symbol	Parameter	Min.	Typ.	Max.	Unit	Remark
$I_L$	LED Supply Current	-	95	-	[mA]	Ta = 25°C, Note 2
$V_L$	LED Supply Voltage	-	33	37.5	[Volt]	I <sub>F</sub> = 95mA, Ta = 25°C Note 2,3
$P_{LED}$	LED Power Consumption	-	25.0	29	[Watt]	I <sub>F</sub> = 95mA, Ta = 25°C Note 3,4,5
$L_L$	LED Life Time	50,000	-	-	Hrs	I <sub>F</sub> =95mA, Ta = 25°C, Note 6,7

Note 1: Ta means ambient temperature of TFT-LCD module.

Note 2:  $I_L$ ,  $V_L$  are defined for one channel LED. There are 8 LED channels in back light unit.

Note 3: LED backlight is 88 LEDs (8 strings, 11pcs for each string)

Note 4: The LED supply power is for 8 strings of LED

Note 5: The voltage capacity of LED driver IC must be over max. of LED Voltage.



Note 6: Definition of life time: Brightness becomes to 50% of its original value.

The minimum life time of LED unit is on the condition of  $I_L = 95 \text{ mA}$  and  $25 \pm 2^\circ\text{C}$  (Room Temperature).

Note 7: If G270ZAN01.5 module is driven by high current or at high ambient temperature & humidity condition. The operating life will be reduce.

## 6. Signal Characteristic

### 6.1 Pixel Format Image

Following figure shows the relationship between input signal and LCD pixel format.

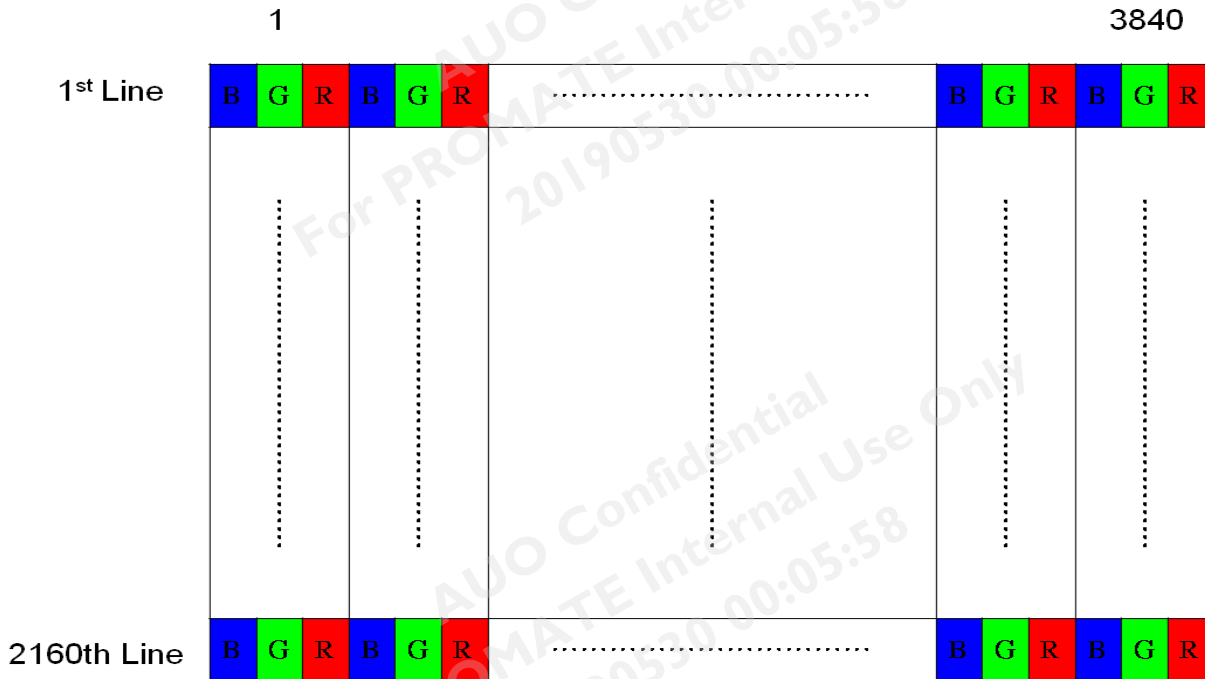

### 6.2 Scanning Direction

The following figures show the image seen from the front view. The arrow indicates the direction of scan.

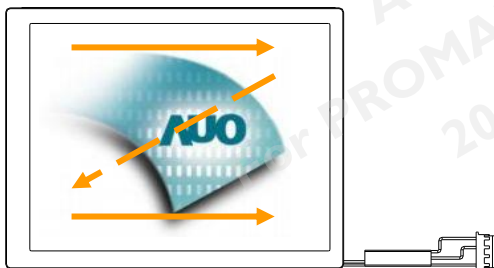

## 6.3 Signal Description

The module uses a LVDS receiver embedded in AUO's ASIC. LVDS is a differential signal technology for LCD interface and a high-speed data transfer device.

### 6.3.1 TFT LCD Module: LVDS Connector

Connector Name / Designation	Signal Connector
Manufacturer	JAE
Connector Model Number	FI-RTE51S-HF
Adaptable Plug	FI-RE51CL

PIN #	Symbol	Description
1	VDD	Power +12V
2	VDD	Power +12V
3	VDD	Power +12V
4	VDD	Power +12V
5	VDD	Power +12V
6	GND	Ground
7	GND	Ground
8	GND	Ground
9	NC	No connection (for AUO test only. Do not connect)
10	NC	No connection (for AUO test only. Do not connect)
11	NC	No connection (for AUO test only. Do not connect)
12	NC	No connection (for AUO test only. Do not connect)
13	NC	No connection (for AUO test only. Do not connect)
14	NC	No connection (for AUO test only. Do not connect)
15	NC	No connection (for AUO test only. Do not connect)
16	NC	No connection (for AUO test only. Do not connect)
17	GND	Ground
18	1st Lane3_N	Negative eDP differential data input
19	1st Lane3_P	Positive eDP differential data input
20	GND	Ground
21	1st Lane2_N	Negative eDP differential data input
22	1st Lane2_P	Positive eDP differential data input
23	GND	Ground
24	1st Lane1_N	Negative eDP differential data input
25	1st Lane1_P	Positive eDP differential data input
26	GND	Ground
27	1st Lane0_N	Negative eDP differential data input
28	1st Lane0_P	Positive eDP differential data input





29	GND	Ground
30	1st AUX_CH_P	Positive AUX Channel differential data input
31	1st AUX_CH_N	Negative AUX Channel differential data input
32	GND	Ground
33	NC	No connection (for AUO test only. Do not connect)
34	GND	Ground
35	NC	No connection (for AUO test only. Do not connect)
36	NC	No connection (for AUO test only. Do not connect)
37	GND	Ground
38	NC	No connection (for AUO test only. Do not connect)
39	NC	No connection (for AUO test only. Do not connect)
40	GND	Ground
41	NC	No connection (for AUO test only. Do not connect)
42	NC	No connection (for AUO test only. Do not connect)
43	GND	Ground
44	NC	No connection (for AUO test only. Do not connect)
45	NC	No connection (for AUO test only. Do not connect)
46	GND	Ground
47	NC	No connection (for AUO test only. Do not connect)
48	NC	No connection (for AUO test only. Do not connect)
49	GND	Ground
50	HPD	Hot plug detection
51	GND	Ground

Note 1: Input Signals shall be in low status when VDD is off.

Note 2: High stands for "3.3V", Low stands for "0V", NC means "No Connection".

Note 3: RSV means "Reserved".

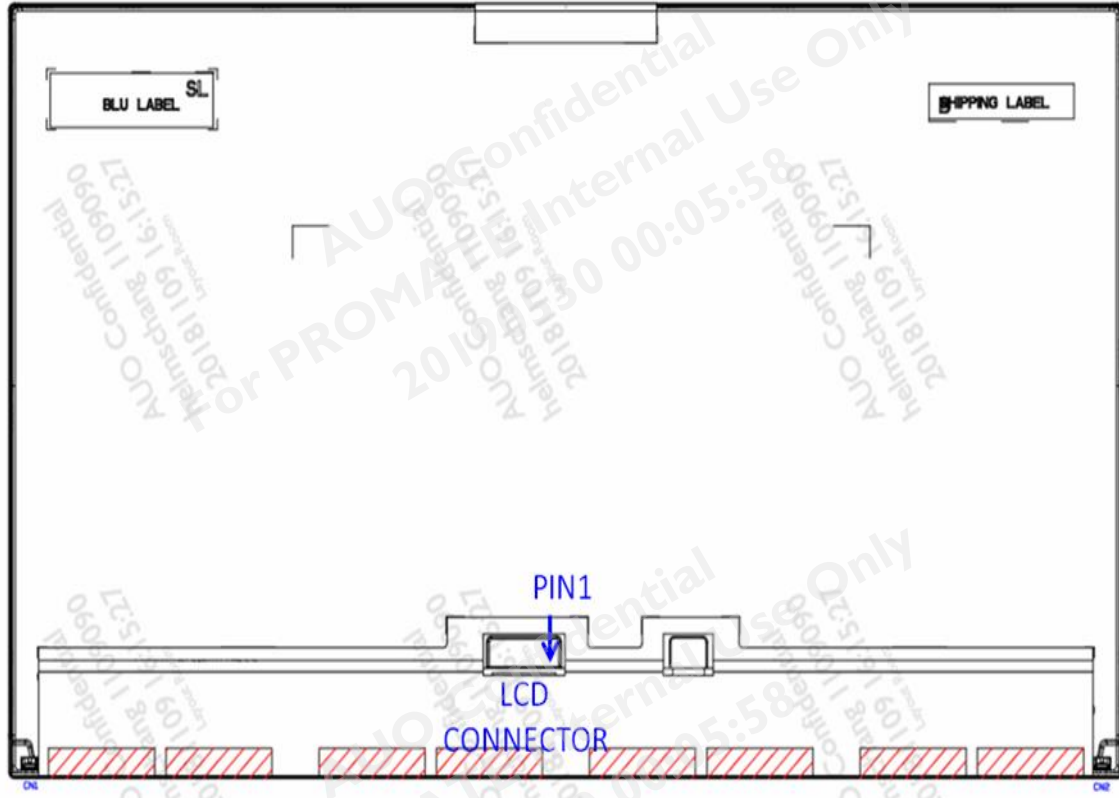



## 6.4.3 Input Timing Diagram

(Lane0~4 eDP data:1, 2, 3, 4, ...,3837,3838,3839,3840)

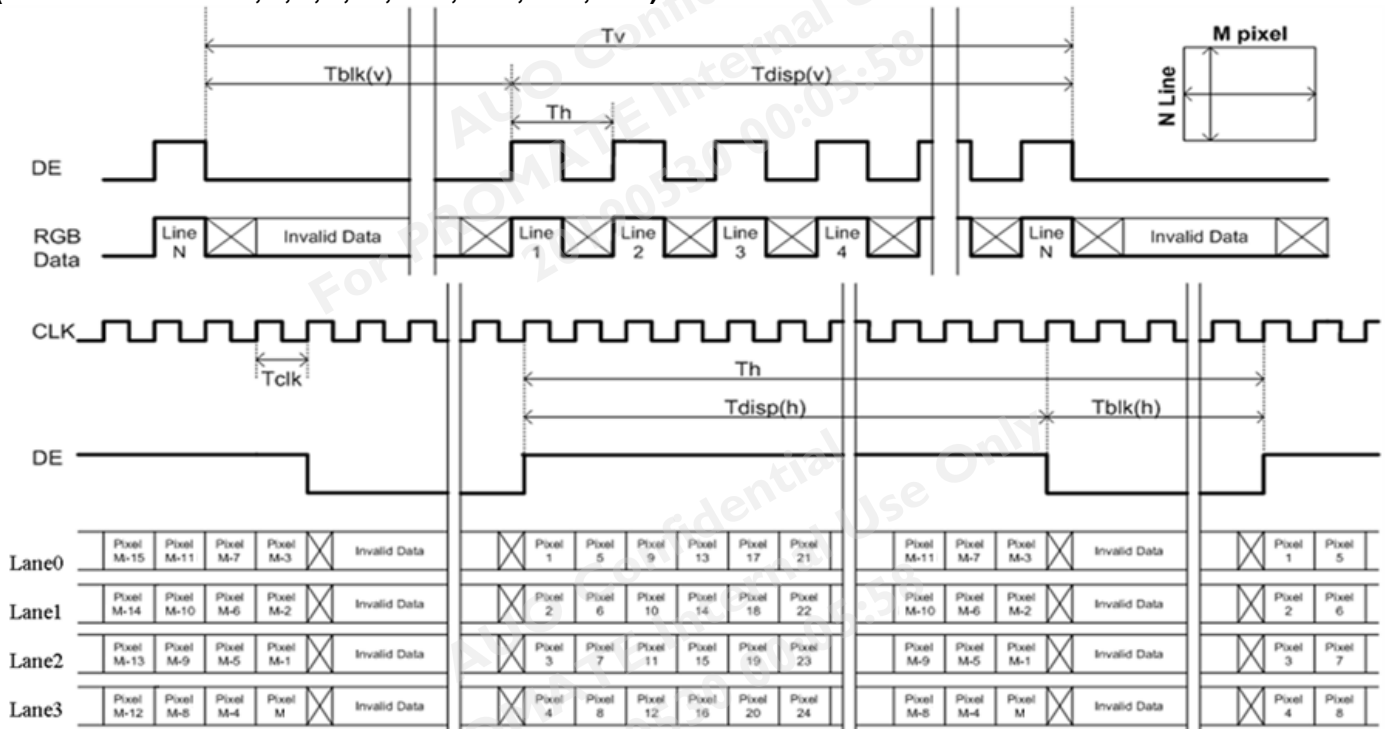

## 6.5 Interface Timing

### 6.5.1 Timing Characteristics

The input timing is shown as the following table.

Symbol	Description	Min.	Typ.	Max.	Unit	Remark	
Tv	Vertical Section	Period	2180	2200	4500	Th	
Tdisp (v)		Active	2160	2160	2160	Th	
Tblk (v)		Blanking	20	40	2340	Th	
Fv		Frequency	50	60	65	Hz	<b>Note 6-6</b>
Th	Horizontal Section	Period	4000	4120	4240	Tclk	
Tdisp (h)		Active	3840	3840	3840	Tclk	
Tblk (h)		Blanking	160	280	400	Tclk	
Fh		Frequency	98.1	132	147.3	kHz	<b>Note 6-4</b>
Tclk	Pixel Clock	Period	2.55	1.84	1.7	ns	1/Fclk
Fclk		Frequency	436	543.8	589.2	MHz	<b>Note 6-5</b>
Link Rate per Lane		5.4			Gbps		

**Note 6-4:** The equation is listed as following. Please don't exceed the above recommended value.

$$Fh (\text{Min.}) = Fclk (\text{Min.}) / Th (\text{Min.})$$

$$Fh (\text{Typ.}) = Fclk (\text{Typ.}) / Th (\text{Typ.})$$

$$Fh (\text{Max.}) = Fclk (\text{Max.}) / Th (\text{Min.})$$

**Note 6-5:** The equation is listed as following. Please don't exceed the above recommended value.

1st Lane N & 2nd Lane N skew < 200ns

$$Fclk (\text{Typ.}) = Fv (\text{Typ.}) \times Th (\text{Typ.}) \times Tv (\text{Typ.})$$

$$Fclk (\text{Min.}) \leq Fv \times Th \times Tv \leq Fclk (\text{Max.})$$

**Note 6-6:** The equation is listed as following. Please don't exceed the above recommended value.

$$Fv = Fclk(\text{Typ.}) / (Tv \times Th)$$

## 6.6 Power ON/OFF Sequence

VDD power and lamp on/off sequence is as below. Interface signals are also shown in the chart. Signals from any system shall be Hi-Z state or low level when VDD is off.

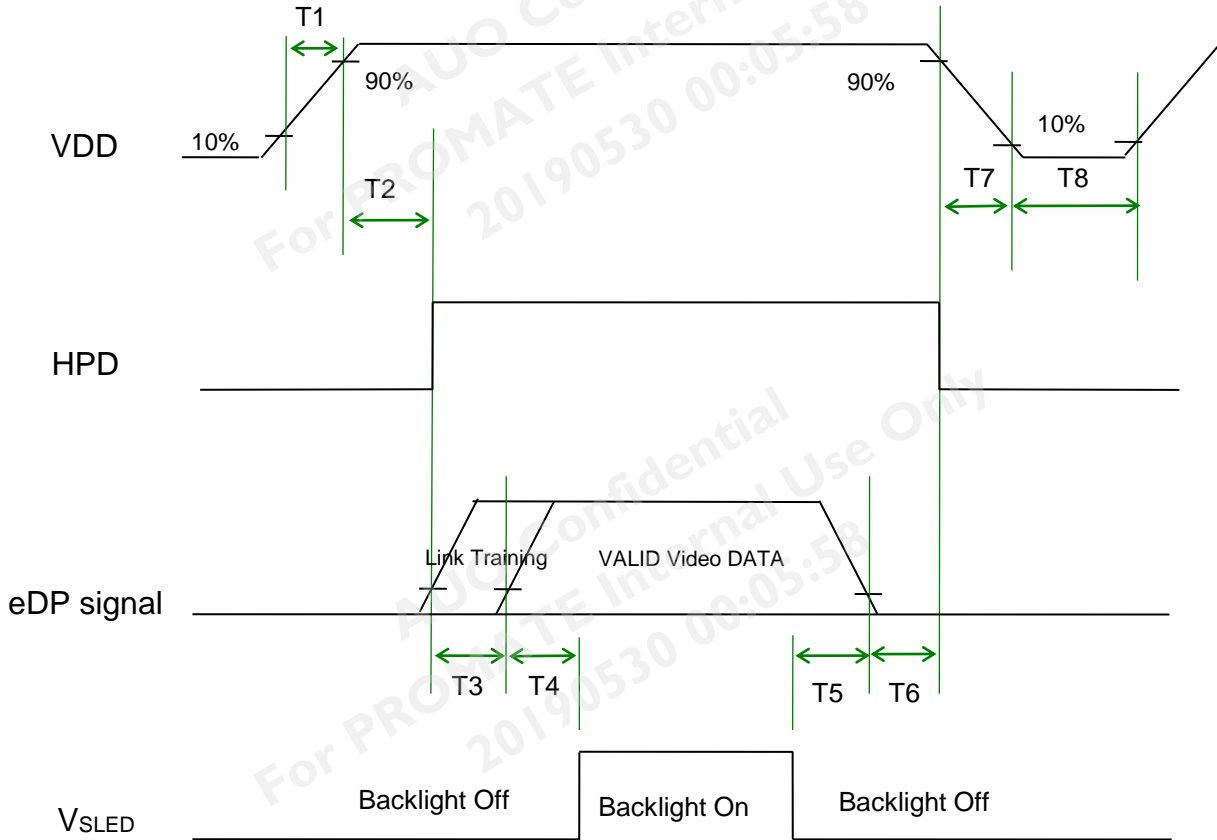

### Power ON/OFF sequence timing

Symbol	Value			Unit	Remark
	Min.	Typ.	Max.		
T1	0.5	-	10	[ms]	
T2	0	-	200	[ms]	
T3	0	-	-	[ms]	
T4	500	-	-	[ms]	
T5	100	-	-	[ms]	
T6	0	-	50	[ms]	
T7	0	-	200	[ms]	
T8	1000	-	-	[ms]	

The above on/off sequence should be applied to avoid abnormal function in the display. Please make sure to turn off the power when you plug the cable into the input connector or pull the cable out of the connector.

## 7. Reliability Test Criteria

Items	Required Condition	Note
Temperature Humidity Bias (THB)	Ta= 50°C, 80%RH, 300hours	
High Temperature Operation (HTO)	Ta= 50°C, 300hours	
Low Temperature Operation (LTO)	Ta= 0°C, 300hours	
High Temperature Storage (HTS)	Ta= 60°C, 300hours	
Low Temperature Storage (LTS)	Ta= -20°C, 300hours	
Vibration Test (Non-operation)	Acceleration: 1.5 G Wave: Random Frequency: 10 - 200Hz Sweep: 30 Minutes each Axis (X, Y, Z)	
Shock Test (Non-operation)	Acceleration: 50 G Wave: Half-sine Active Time: 20 ms Direction: ±X, ±Y, ±Z (one time for each Axis)	
Drop Test	Height: 60 cm, package test	
Thermal Shock Test (TST)	-20 °C /30min, 60°C /30min, 100 cycles	<b>Note 1</b>
On/Off Test	On/10sec, Off/10sec, 30,000 cycles	
ESD (Electrostatic Discharge)	Contact Discharge: ± 8KV, 150pF(330Ω ) 1sec, 9 points, 25 times/ point.	<b>Note 2</b>
	Air Discharge: ± 15KV, 150pF(330Ω ) 1sec 9 points, 25 times/ point.	
Altitude Test	Operation:10,000 ft Non-Operation:30,000 ft	

**Note 1:** The TFT-LCD module will not sustain damage after being subjected to 100 cycles of rapid temperature change.

- A cycle of rapid temperature change consists of varying the temperature from -20°C to 60°C, and back again. Power is not applied during the test.
- After finish temperature cycling, the unit is placed in normal room ambient for at least 4 hours before power on.

**Note 2:** According to EN61000-4-2 , ESD class B: Some performance degradation allowed. No data lost. Self-recoverable. No hardware failures.

**Note 3:**

- Water condensation is not allowed for each test items.
- Each test is done by new TFT-LCD module. Don't use the same TFT-LCD module repeatedly for reliability test.
- The reliability test is performed only to examine the TFT-LCD module capability.



# Product Specification

G270ZAN01.5

AU OPTRONICS CORPORATION

- d. To inspect TFT-LCD module after reliability test, please store it at room temperature and room humidity for 24 hours at least in advance.

AUO Confidential  
For PROMATE Internal Use Only  
20190530 00:05:58





### 8. Mechanical Characteristics

#### 8.1 LCM Outline Dimension

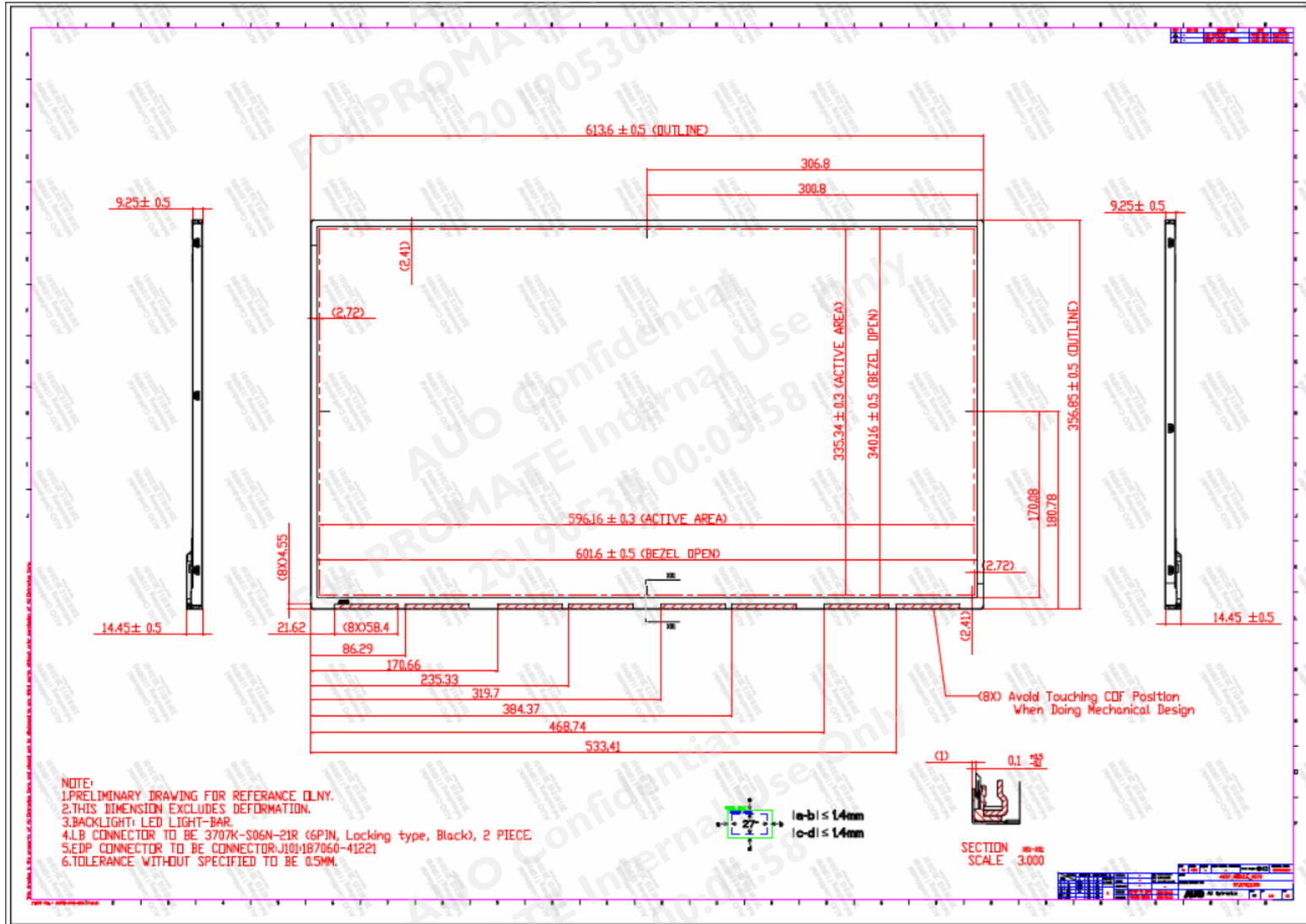



# Product Specification

AU OPTRONICS CORPORATION

G270ZAN01.5

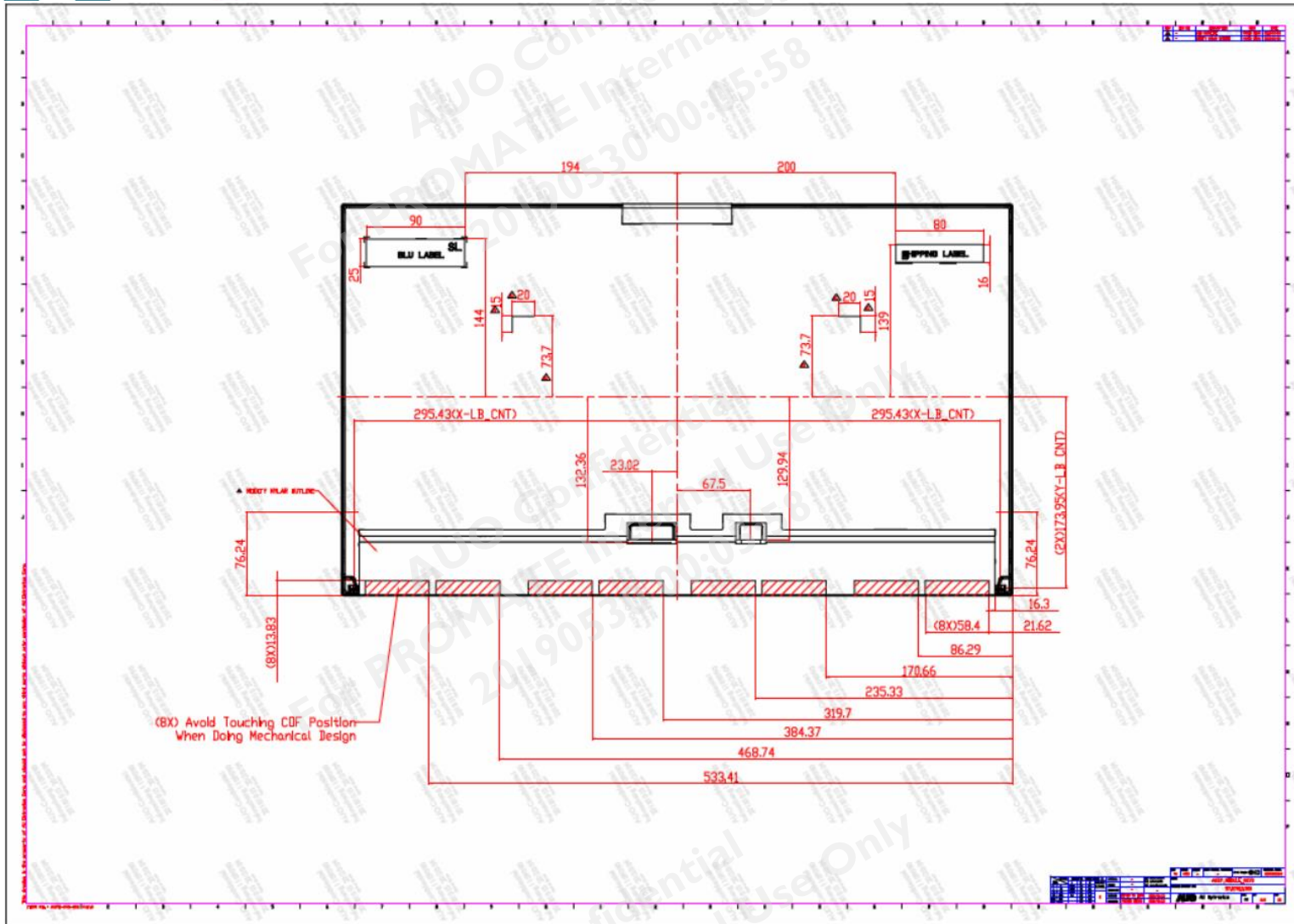

## 9. Label and Packaging

### 9.1 Shipping Label (on the rear side of TFT-LCD display)

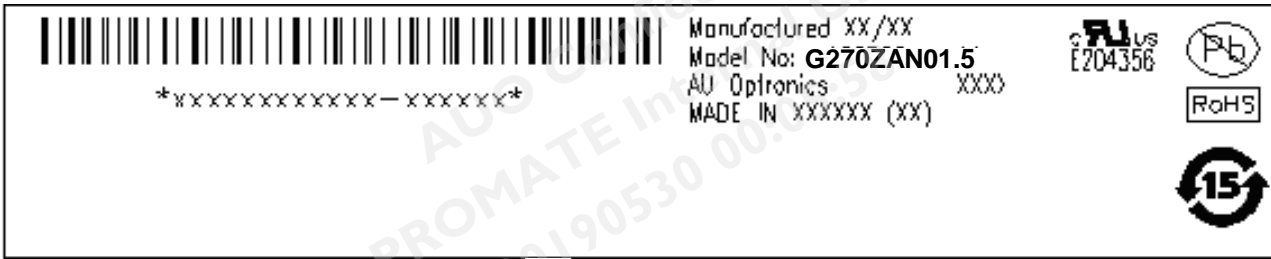

Note 1: For Pb Free products, AUO will add  for identification.

Note 2: For RoHS compatible products, AUO will add  for identification.

Note 3: For China RoHS compatible products, AUO will add  for identification.

Note 4: The Green Mark will be presented only when the green documents have been ready by AUO Internal Green Team.

## 9.2 Carton Package

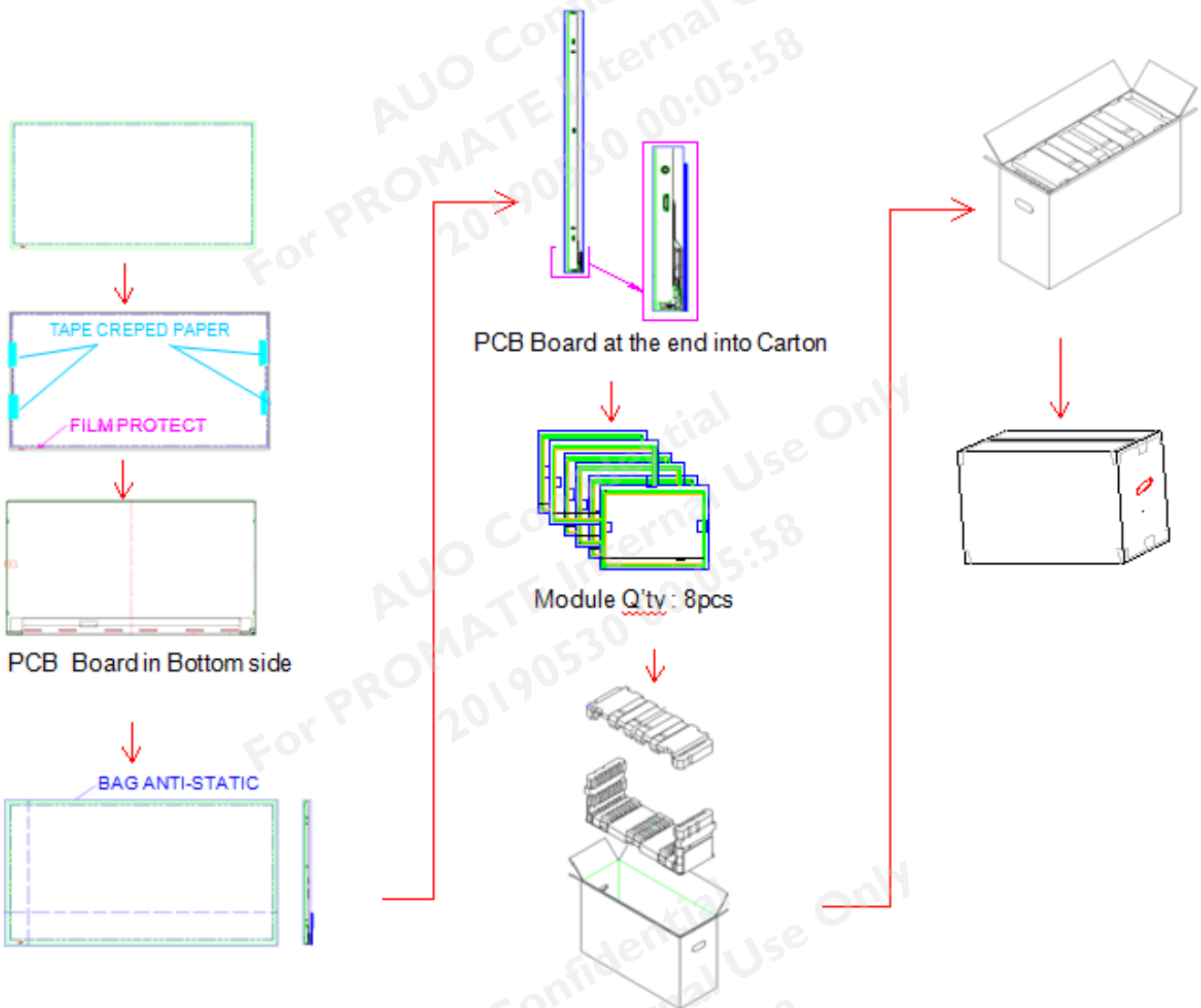

- Max capacity : 8 pcs TFT-LCD module per carton
  - Max weight: 22.2 kg per carton
  - Outside dimension of carton: 702mm(L)\* 264mm(W)\*456mm(H)
  - Pallet size : 1070 mm \* 740 mm \* 132mm
  - Box stacked
- Module by air\_Max : (1\*4) \*2 layers , one pallet put 8 boxes , total 64pcs module  
 Module by sea\_Max : (1\*4) \*2 layers + (1\*4) \*1 layers , two pallet put 12 boxes , total 96pcs module  
 Module by sea\_HQ\_Max : (1\*4) \*2 layers + (1\*4) \*2 layers , two pallet put 16 boxes , total 128pcs module



## 10 Safety

### 10.1 Sharp Edge Requirements

There will be no sharp edges or comers on the display assembly that could cause injury.

### 10.2 Materials

#### 10.2.1 Toxicity

There will be no carcinogenic materials used anywhere in the display module. If toxic materials are used, they will be reviewed and approved by the responsible AUO toxicologist.

#### 10.2.2 Flammability

All components including electrical components that do not meet the flammability grade UL94-V1 in the module will complete the flammability rating exception approval process.

The printed circuit board will be made from material rated 94-V1 or better. The actual UL flammability rating will be printed on the printed circuit board.

### 10.3 Capacitors

If any polarized capacitors are used in the display assembly, provisions will be made to keep them from being inserted backwards.

### 10.4 National Test Lab Requirement

The display module will satisfy all requirements for compliance to:

UL 60950-1 second edition

U.S.A. Information Technology Equipment