

Female Screw Locks F-GSCH1/5...  
Hex. 4.5 mm (0.177")

Sechskantbolzen F-GSCH1/5...  
Schlüsselweite 4,5 mm

Outer Thread 4-40 UNC, Inner Thread 4-40 UNC

Außengewinde 4-40 UNC, Innengewinde 4-40 UNC

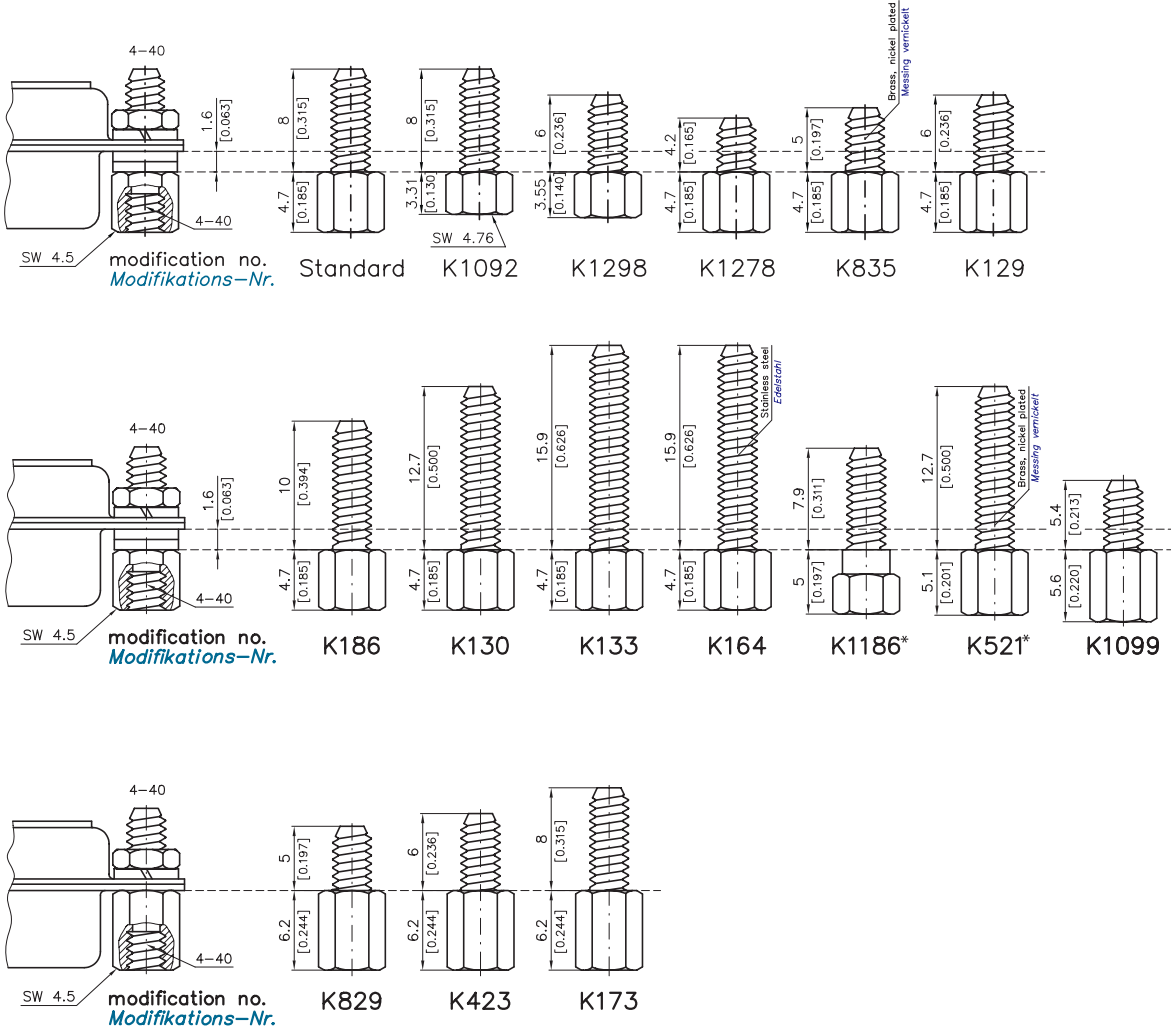

Outer Thread M3, Inner Thread M3

Außengewinde M3, Innengewinde M3

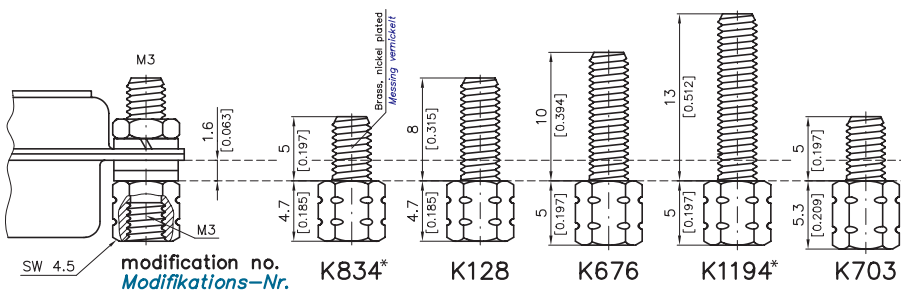

Female Screw Locks F-GSCH1/5...  
Hex. 4.5 mm (0.177")

Sechskantbolzen F-GSCH1/5...  
Schlüsselweite 4,5 mm

Outer Thread M3, Inner Thread M3

Außengewinde M3, Innengewinde M3

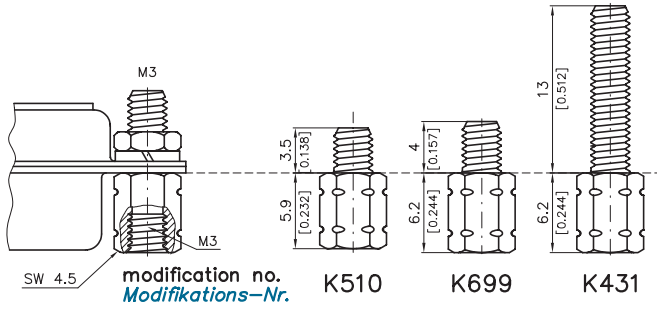

Outer Thread 4-40 UNC, Inner Thread M3

Außengewinde 4-40 UNC, Innengewinde M3

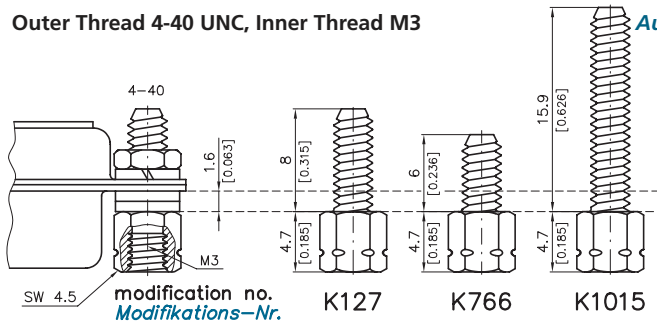

Outer Thread M3, Inner Thread 4-40 UNC

Außengewinde M3, Innengewinde 4-40 UNC

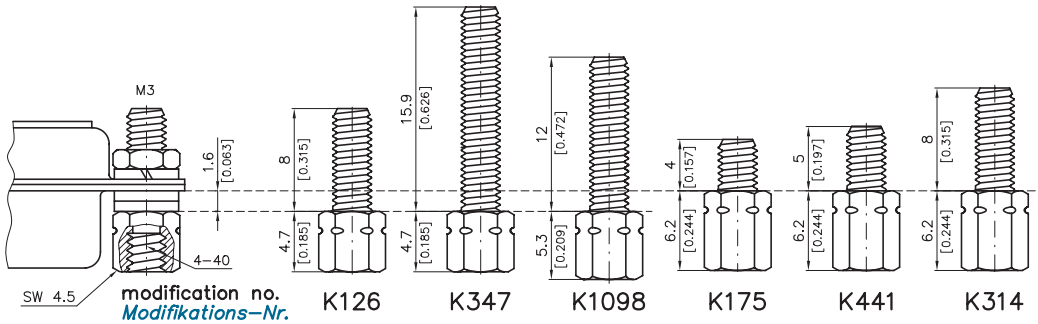

Outer Thread M2,5; Inner Thread 4-40 UNC

Außengewinde M2,5; Innengewinde 4-40 UNC

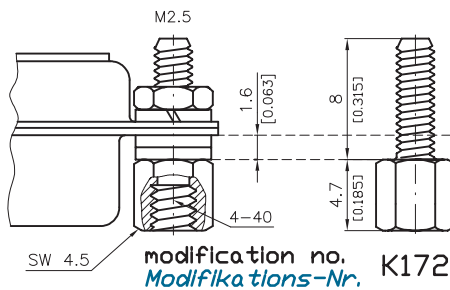

Female Screw Locks F-GSCH1/5...  
Hex. 5.0 mm (0.197")

Sechskantbolzen F-GSCH1/5...  
Schlüsselweite 5,0 mm

Outer Thread M3, Inner Thread M3

Außengewinde M3, Innengewinde M3

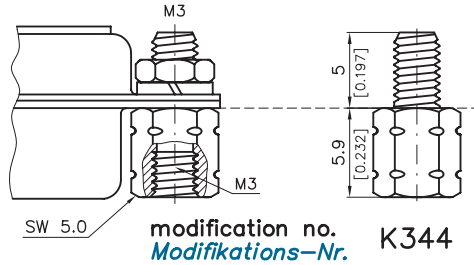

Outer Thread 4-40 UNC,  
Inner Thread 4-40 UNC

Außengewinde 4-40 UNC,  
Innengewinde 4-40 UNC

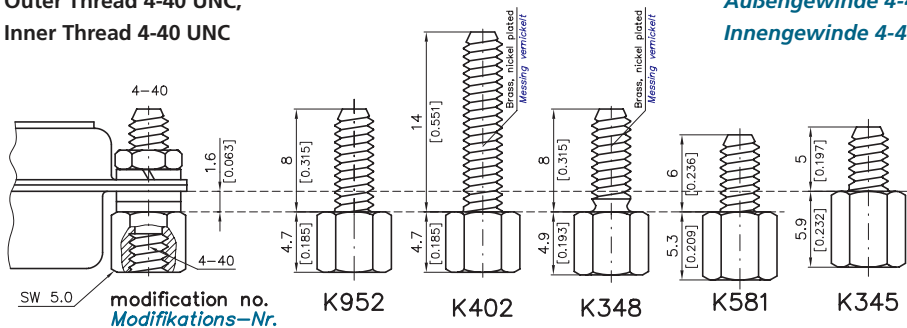

**Ordering Example**

Female screw lock, spanner size Hex. 4,5 mm (0.177"), outer thread M3, length 5 mm (0.197"), inner thread 4-40 UNC, head size 6.2 mm (0.244"), tin plated:

**F-GSCH1/5-K441SN**

**Bestellbeispiel**

Sechskantbolzen mit Schlüsselweite 4,5 mm, Außengewinde M3, Länge 5 mm, Innengewinde 4-40 UNC, Kopfhöhe 6,2 mm, verzinkt: **F-GSCH1/5-K441SN**

**Delivery Quantity**

Washers are not included for head size 5.9 mm (0.232") or 6.2 mm (0.244"). All female screw locks are packed in pairs (that means 2 bolts, 4 washers, 2 spring washers, 2 nuts). Also available bulk packed on request.

\* Please request the number of accessories included.

**Lieferumfang**

Bei Kopfhöhe 5,9 mm oder 6,2 mm sind im Lieferumfang keine Unterlegscheiben enthalten. Alle Sechskantbolzen sind paarweise (d.h. 2 Bolzen, 4 Unterlegscheiben, 2 Federringe, 2 Muttern) verpackt. Auf Anfrage auch als Schüttware lieferbar.

\* Die Anzahl des beigefügten Zubehörs bitte anfragen.

**Technical Data**

**Technische Daten**

|                               | Zinc Plated Version<br><i>Verzinkte Ausführung</i> | Tin Plated Version<br><i>Verzinnte Ausführung</i> |
|-------------------------------|--|---|
| Material                      | Steel, zinc plated, blue chromate                  | Steel, tin plated                                 |
| <i>Material</i>               | <i>Stahl, verzinkt, blau chromatiert</i>           | <i>Stahl, verzinnt</i>                            |
| Order number                  | F-GSCH1/5-...                                      | F-GSCH1/5-...SN                                   |
| <i>Bestellnummer</i>          |  |   |
| Maximum torque                | 48Ncm (0.356 ft.lbf)                               |   |
| <i>Maximales Anzugsmoment</i> | 48Ncm  |   |

