



## SPECIFICATIONS

CUSTOMER : CDE021  
SAMPLE CODE : SH800480T013-IDA01  
MASS PRODUCTION CODE : PH800480T013-IDA01  
SAMPLE VERSION : 01  
SPECIFICATIONS EDITION : 002  
DRAWING NO. (Ver.) : JLMD- PH800480T013-IDA01 \_001  
PACKAGING NO. (Ver.) : JPKG- PH800480T013-IDA01 \_001

### Customer Approved

Date:

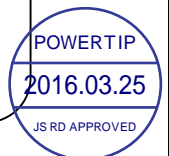

Approved	Checked	Designer
閔偉	劉進	譚超敏

- Preliminary specification for design input
- Specification for sample approval

## POWERTIP TECH. CORP.

### Headquarters:

No.8, 6<sup>th</sup> Road, Taichung Industrial Park,  
Taichung, Taiwan  
台中市 407 工業區六路 8 號

TEL: 886-4-2355-8168  
FAX: 886-4-2355-8166

E-mail: [sales@powertip.com.tw](mailto:sales@powertip.com.tw)  
[Http://www.powertip.com.tw](http://www.powertip.com.tw)



## History of Version

Date (mm / dd / yyyy)	Ver.	Edi.	Description	Page	Design by
11/30/2015	01	001	New Drawing	-	譚超敏
03/22/2016	01	002	New Sample	-	譚超敏

Total: 29 Page

## Contents

### 1. SPECIFICATIONS

- 1.1 Features
- 1.2 Mechanical Specifications
- 1.3 Absolute Maximum Ratings
- 1.4 DC Electrical Characteristics
- 1.5 Optical Characteristics
- 1.6 Backlight Characteristics

### 2. MODULE STRUCTURE

- 2.1 Counter Drawing
- 2.2 Interface Pin Description
- 2.3 Timing Characteristics

### 3. QUALITY ASSURANCE SYSTEM

- 3.1 Quality Assurance Flow Chart
- 3.2 Inspection Specification

### 4. RELIABILITY TEST

- 4.1 Reliability Test Condition

### 5. PRECAUTION RELATING PRODUCT HANDLING

- 5.1 Safety
- 5.2 Handling
- 5.3 Storage
- 5.4 Terms of Warranty

Appendix : 1.LCM Drawing  
2.Packaging

## 1. SPECIFICATIONS

### 1.1 Features

Item	Standard Value
Display Type	800 * (RGB) * 480
LCD Type	TN , Normally white , Transmissive type
Screen size(inch)	7.0 inch
Viewing Direction	6 O'clock
Interface	RGB Interface
ROHS	THIS PRODUCT CONFORMS THE ROHS OF PTC Detail information please refer web site : <a href="http://www.powertip.com.tw/news.php?area_id_view=1085560481/">http://www.powertip.com.tw/news.php?area_id_view=1085560481/</a>

### 1.2 Mechanical Specifications

Item	Standard Value	Unit
Outline Dimension	164.9(L)*100(W)*5.7(H)	mm

#### LCD panel& Touch Panel

Item	Standard Value	Unit
Active Area	154.08 (W) * 85.92 (L)	mm
Dot pitch	0.1926 (W) * 0.1790 (L)	mm

Note : For detailed information please refer to LCM drawing.

### 1.3 Absolute Maximum Ratings

#### Module

Item	Symbol	Condition	Min.	Max.	Unit	Remark
Power Supply Voltage	$DV_{DD}$	GND=0	-0.3	5.0	V	-
	$AV_{DD}$		6.5	13.5	V	
	$V_{GH}$		-0.3	40	V	
	$V_{GL}$	AGND=0	-20	0.3	V	
	$V_{GH} - V_{GL}$	-	0	40	V	
Operating Temperature	$T_{OP}$	-	-20	70	°C	
Storage Temperature	$T_{ST}$	-	-30	80	°C	

The absolute maximum rating values of this product are not allowed to be exceeded at any times. Should a module be used with any of the absolute maximum ratings exceeded, the characteristics of the module may not be recovered, or in an extreme case, the module may be permanently destroyed.

## 1.4 DC Electrical Characteristics

Module

GND = 0V, Ta = 25°C

Item	Symbol	Min.	Typ.	Max.	Unit	Remark
Supply Voltage	$DV_{DD}$	3.0	3.3	3.6	V	-
	$V_{GH}$	15.3	16.0	16.7		
	$V_{GL}$	-7.7	-7.0	-6.3		
	$AV_{DD}$	10.2	10.4	10.6		
VCOM	$V_{COM}$	3.8	4.0	4.2	V	-
Input signal Voltage	$V_{IH}$	$0.7DV_{DD}$	-	$DV_{DD}$	V	-
	$V_{IL}$	0	-	$0.3DV_{DD}$		
Supply Current	$I(DV_{DD})$	-	4.0	10	mA	DVDD=3.3V
	$I(AV_{DD})$	-	20	50		AVDD=10.4V

## 1.5 Optical Characteristics

### TFT LCD Module

DV<sub>DD</sub> = 3.3 V, Ta=25°C

Item		Symbol	Condition	Min.	Typ.	Max.	unit	
Response time	Rise	Tr	-	-	10	20	ms	Note 2
	Fall	Tf		-	15	30		
Viewing angle	Top	θ+	CR ≥ 10	40	50	-	Deg.	Note 1
	Bottom	θ-		60	70	-		
	Left	θL		60	70	-		
	Right	θR		60	70	-		
Contrast ratio		CR		400	500	-		Note 3
Color of CIE Coordinate ( With B/L )	White	X	If=270mA	-	0.31	-	-	Note4
		Y		-	0.33	-		
	Red	X		-	0.58	-		
		Y		-	0.35	-		
	Green	X		-	0.34	-		
		Y		-	0.59	-		
	Blue	X		-	0.15	-		
		Y		-	0.08	-		
Average Brightness Pattern=white display (With B/L)*1		IV	If=270mA	800	1000	-	cd/m <sup>2</sup>	Note1
Uniformity (With B/L )*2		△B	-	70	-	-	%	Note1

Note 4 :

1 :  $\Delta B = B(\min) / B(\max) * 100\%$

2 : Measurement Condition for Optical Characteristics:

a : Environment: 25°C ± 5°C / 60 ± 20% R.H , no wind , dark room below 10 Lux at typical lamp current and typical operating frequency.

b : Measurement Distance: 500 ± 50 mm , (θ = 0°)

c : Equipment: TOPCON BM-7 fast , (field 1°) , after 10 minutes operation.

d : The uncertainty of the C.I.E coordinate measurement ± 0.01 , Average Brightness ± 4%

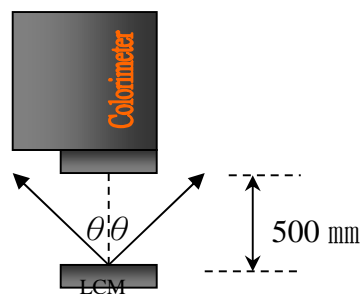
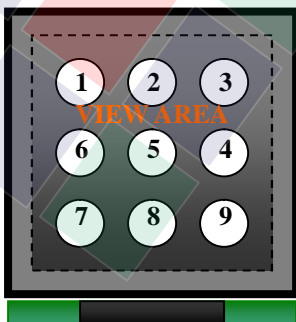

Colorimeter=BM-7 fast

Note 1.

Optical characteristics-2

Viewing angle

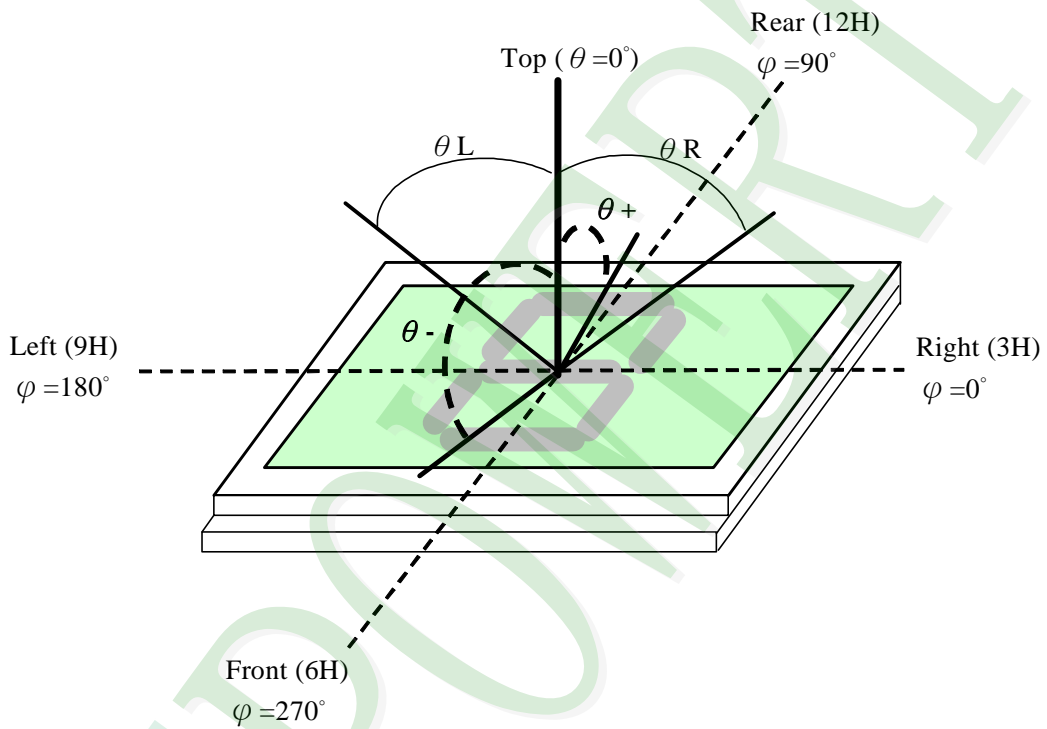

Viewing angle



Note 2.

Optical characteristics-3

Fig.2 Definition of response time

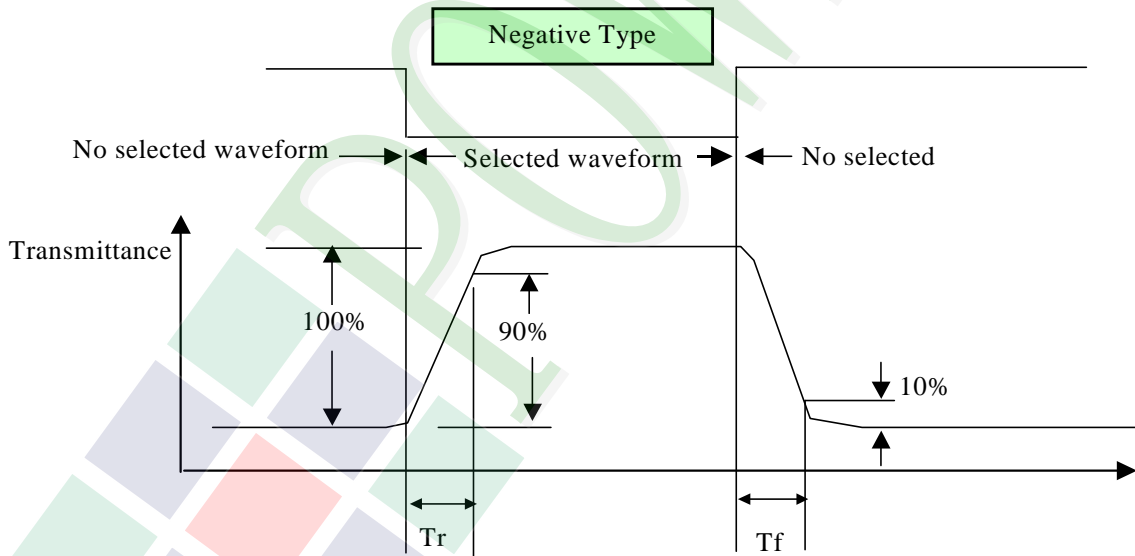
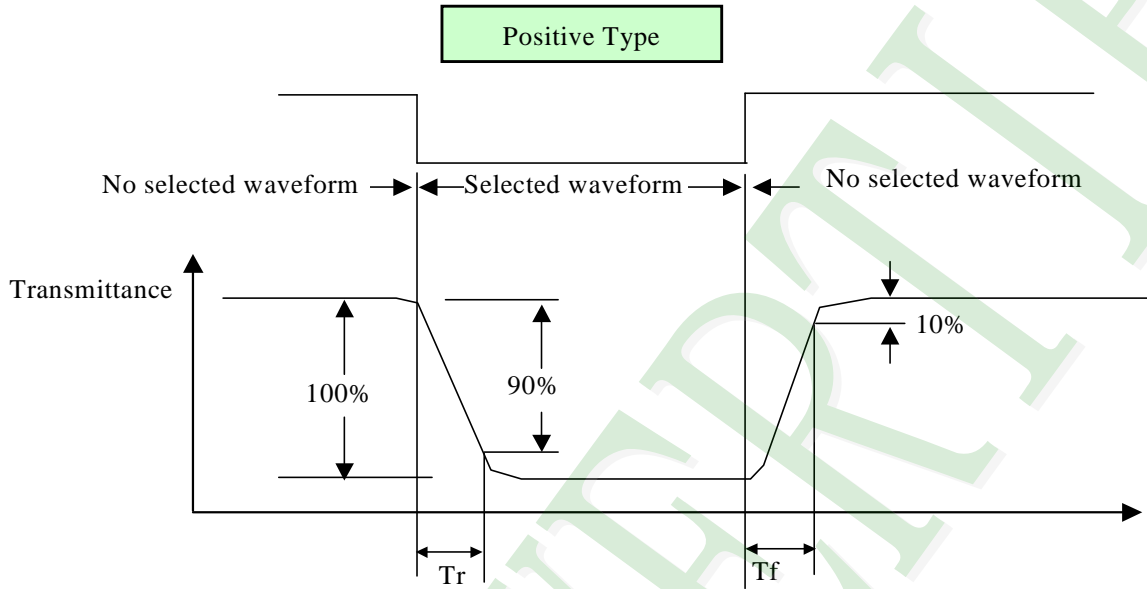

## Electrical characteristics-2

※2 Drive waveform

$V_{op}$ : Drive voltage

$1/B$ : Bias

$N$ : Duty

$f_F$ : Frame frequency

$f_D$ : Drive frequency

### (1) Selected waveform

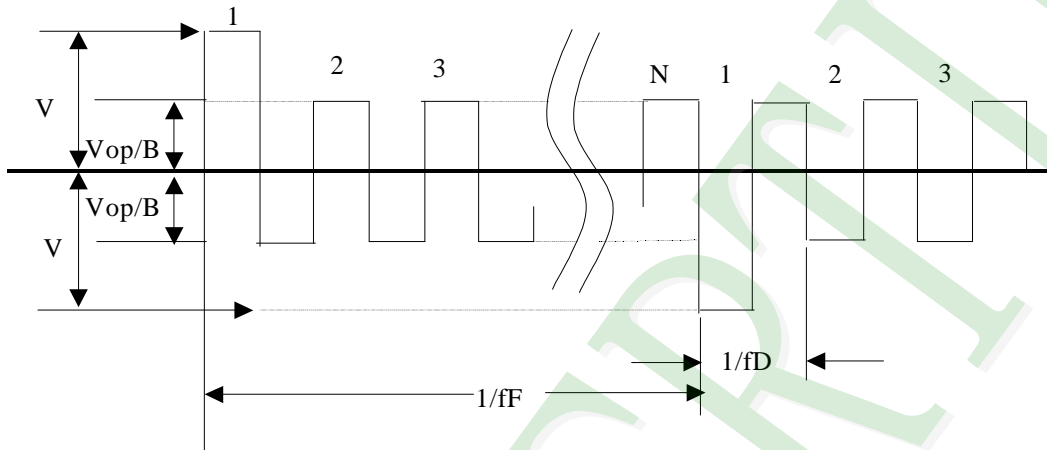

### (2) Non- Selected wave form

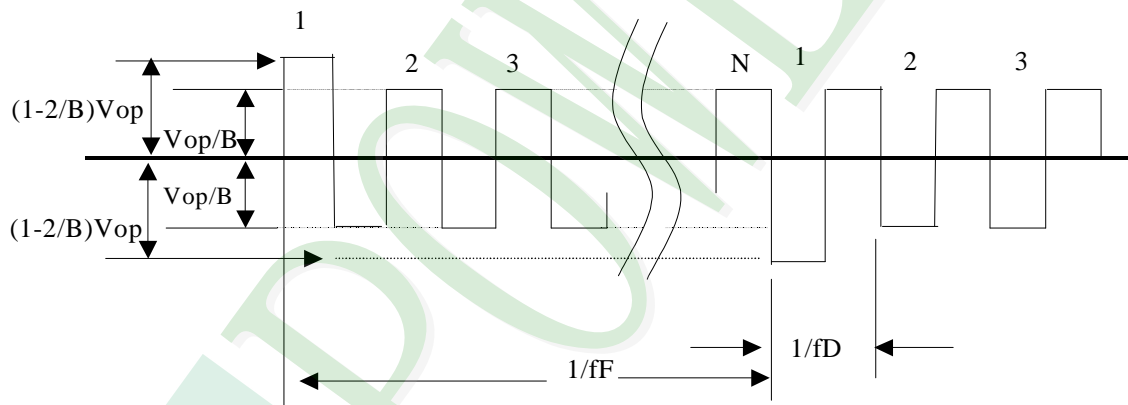

Note:

Frame frequency is defined as follows: Common side supply voltage peak - to - peak / 2 = 1 period

Note 3. : Definition of Vth

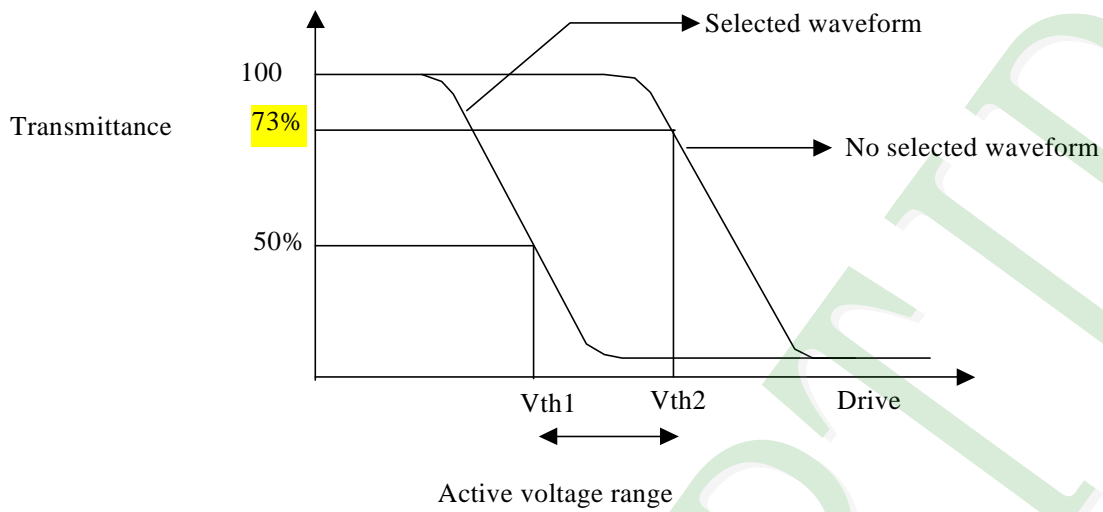

	Vth1	Vth2
View direction	10°	40°
Drive waveform	(Selected waveform)	(No selected waveform)
Transmittance	50%	73%

※ 1 Contrast ratio  
 = (Brightness in OFF state) / (Brightness in ON state)

Outline of Electro-Optical Characteristics Measuring System

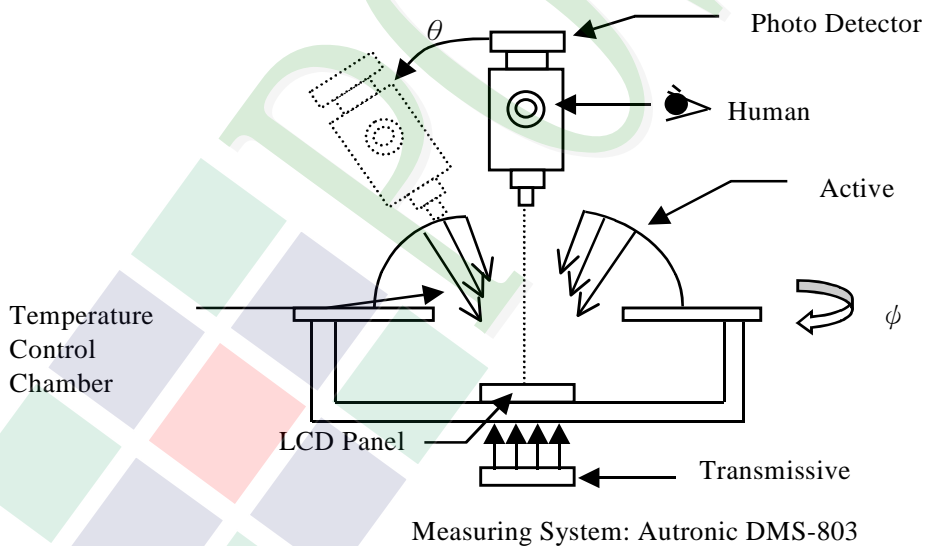

## 1.6 Backlight Characteristics

### Electrical / Optical Characteristics

Item	Symbol	Conditions	Min.	Typ.	Max.	Unit
Forward Voltage	VF	If=270mA	8.7	9.6	10.5	V
Supply Current	IF	-	-	270	-	mA
Color	White					

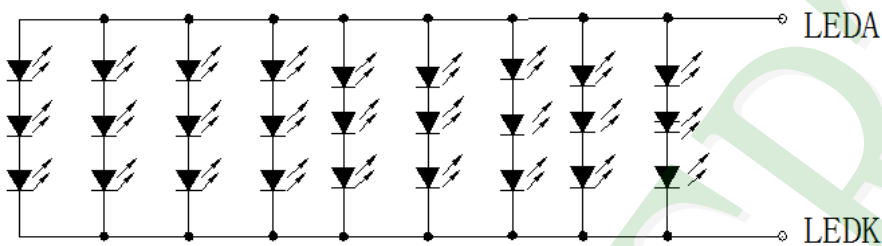

VF=9.6V (Typ), IF=270mA (Fix)

### Other Description

Item	Conditions	Description
Life Time	Ta =25°C IF= 30mA	30000 hrs

## 2. MODULE STRUCTURE

### 2.1 Counter Drawing

#### 2.1.1 LCM Mechanical Diagram

\* See Appendix

#### 2.1.2 Block Diagram

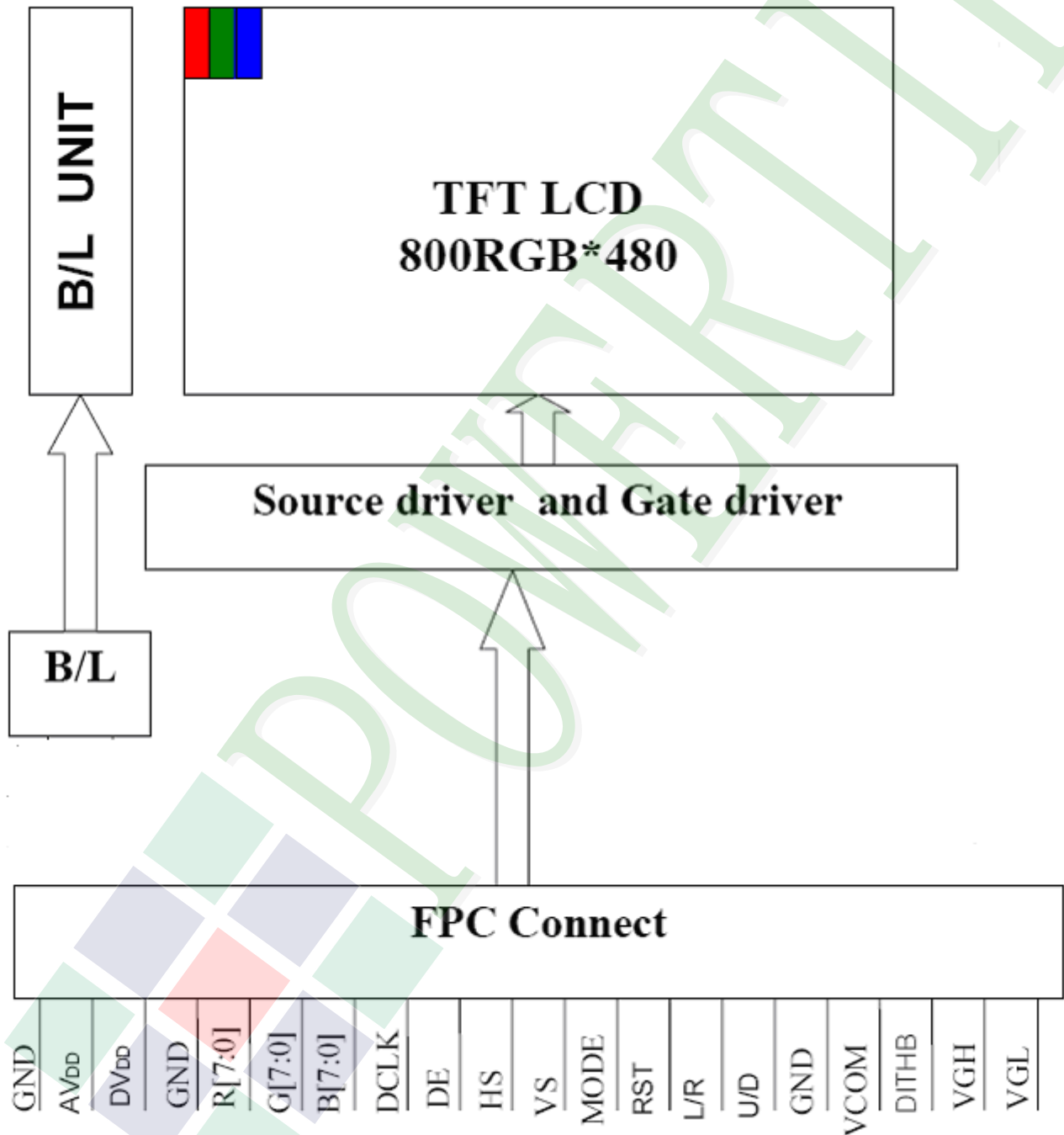

## 2.2 Interface Pin Description

Pin NO.	SYMBOL	DESCRIPTION
1	V <sub>LED+</sub>	Power For LED backlight (+).
2	V <sub>LED+</sub>	Power For LED backlight (+).
3	V <sub>LED-</sub>	Power For LED backlight (-).
4	V <sub>LED-</sub>	Power For LED backlight (-).
5	GND	Power ground.
6	V <sub>com</sub>	Common voltage.
7	DV <sub>DD</sub>	Power for Digital Circuit.
8	MODE	DE/SYNC mode select.
9	DE	Data Input Enable.
10	VS	Vertical Sync Input.
11	HS	Horizontal Sync Input.
12	B7	Blue Data(MSB).
13	B6	Blue Data.
14	B5	Blue Data.
15	B4	Blue Data.
16	B3	Blue Data.
17	B2	Blue Data.
18	B1	Blue Data.
19	B0	Blue Data(LSB).
20	G7	Green Data(MSB).
21	G6	Green Data.
22	G5	Green Data.
23	G4	Green Data.
24	G3	Green Data.
25	G2	Green Data.
26	G1	Green Data.
27	G0	Green Data(LSB).
28	R7	Red Data(MSB).
29	R6	Red Data.
30	R5	Red Data.
31	R4	Red Data.
32	R3	Red Data.
33	R2	Red Data.
34	R1	Red Data.
35	R0	Red Data(LSB).
36	GND	Power Ground
37	DCLK	Sample clock

Pin NO.	SYMBOL	DESCRIPTION
38	GND	Power Ground.
39	L/R	Left / right selection.
40	U/D	Left / right selection.
41	V <sub>GH</sub>	Gate On Voltage.
42	V <sub>GL</sub>	Gate OFF Voltage.
43	AV <sub>DD</sub>	Power for Analog Circuit.
44	RESET	Global reset pin.
45	NC	No connection.
46	V <sub>COM</sub>	Common Voltage.
47	DITHB	Dithering Function.
48	GND	Power Ground.
49	NC	No connection.
50	NC	No connection.

【Note1】 L/R : left or right setting

U/D : up or down setting

L/R	U/D	Data shifting
DVDD	GND	Left → Right , Up → Down(default)
GND	GND	Right → Left , Up → Down
DVDD	DVDD	Left → Right , Down → Up
GND	DVDD	Right → Left , Down → Up

Definition of scanning direction:

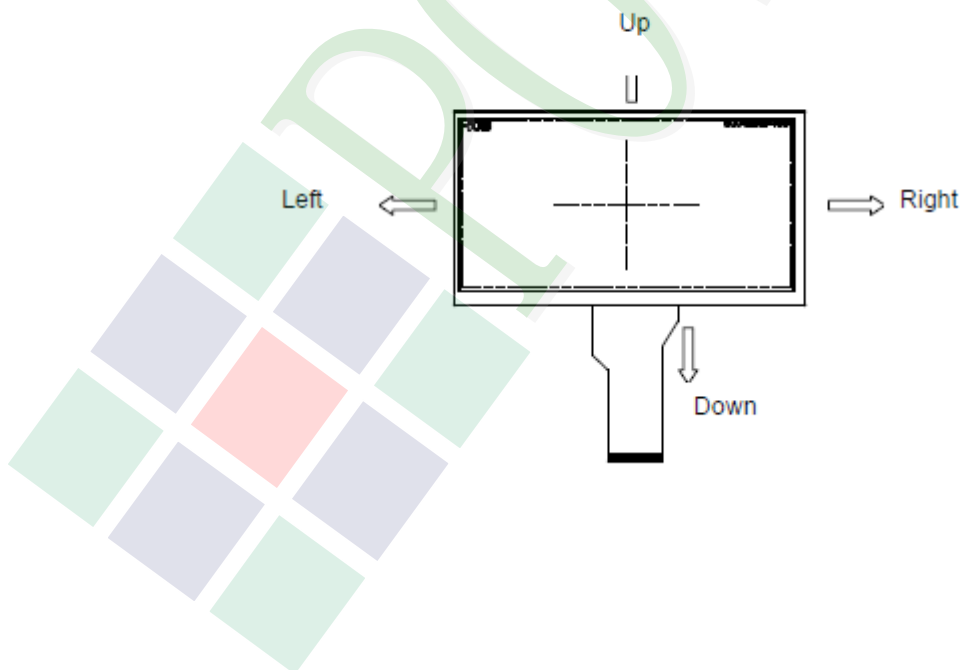

## 2.3 Timing Characteristics

### 2.3.1 AC Electrical Characteristics

Item	Symbol	Values			Unit	Remark
		Min.	Typ.	Max.		
HS setup time	$T_{hst}$	8	-	-	ns	
HS hold time	$T_{hhd}$	8	-	-	ns	
VS setup time	$T_{vst}$	8	-	-	ns	
VS hold time	$T_{vhd}$	8	-	-	ns	
Data setup time	$T_{dsu}$	8	-	-	ns	
Data hole time	$T_{dhd}$	8	-	-	ns	
DE setup time	$T_{esu}$	8	-	-	ns	
DE hole time	$T_{ehd}$	8	-	-	ns	
DV <sub>DD</sub> Power On Slew rate	$T_{POR}$	-	-	20	ms	From 0 to 90% DV <sub>DD</sub>
RESET pulse width	$T_{Rst}$	1	-	-	ms	
DCLK cycle time	$T_{coh}$	20	-	-	ns	
DCLK pulse duty	$T_{cwh}$	40	50	60	%	

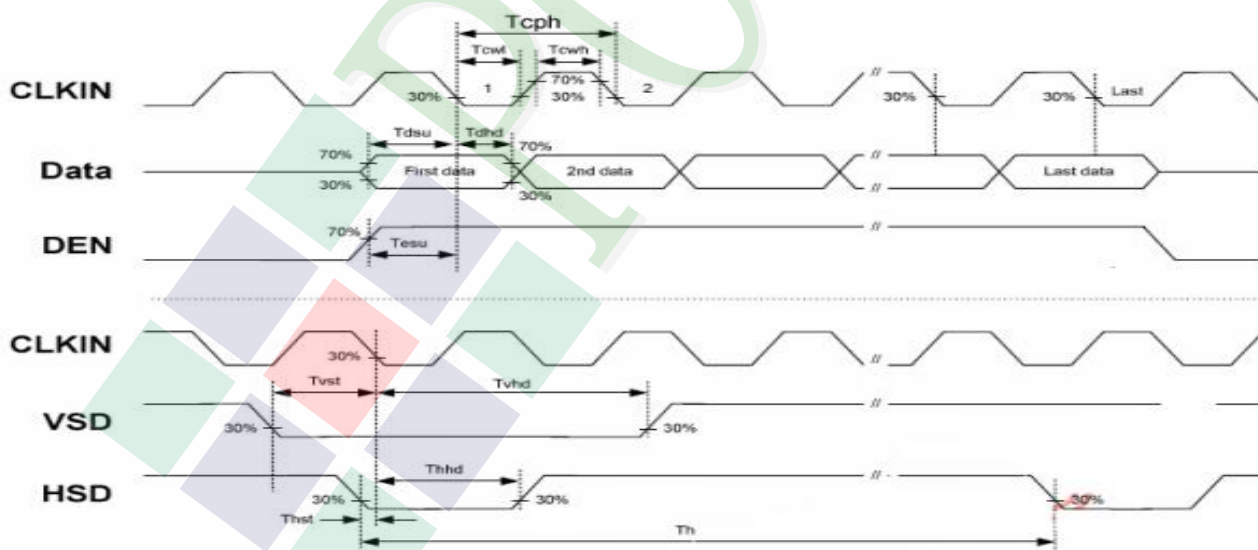



### 2.3.2 Data Input Format

#### Horizontal input timing diagram



#### Vertical input timing diagram

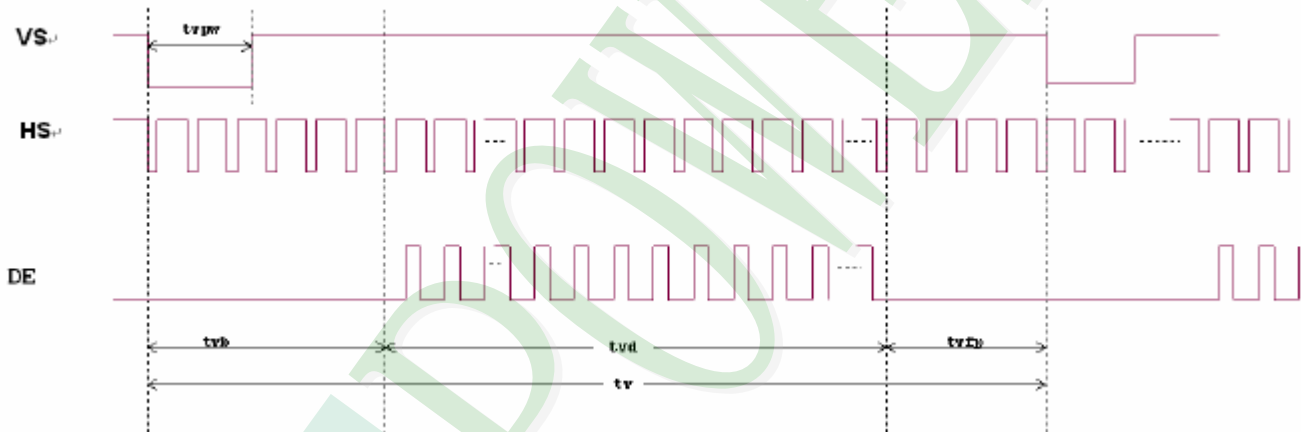



Item	Symbol	Values			Unit	Remark
		Min.	Typ.	Max.		
Horizontal Display Area	thd	-	800	-	DCLK	
DCLK Frequency	fclk	26.4	33.3	46.8	MHz	
One Horizontal Line	th	862	1056	1200	DCLK	
HS pulse width	thpw	1	-	40	DCLK	
HS Blanking	thb	46	46	46	DCLK	
HS Front Porch	thfp	16	210	354	DCLK	

Item	Symbol	Values			Unit	Remark
		Min.	Typ.	Max.		
Vertical Display Area	tvd	-	480	-	TH	
VS period time	tv	510	525	650	TH	
VS pulse width	tvpw	1	-	20	TH	
VS Blanking	tvb	23	23	23	TH	
VS Front Porch	tvfp	7	22	147	TH	

### 2.3.3 Power On/Off Characteristics

#### a. Power on:

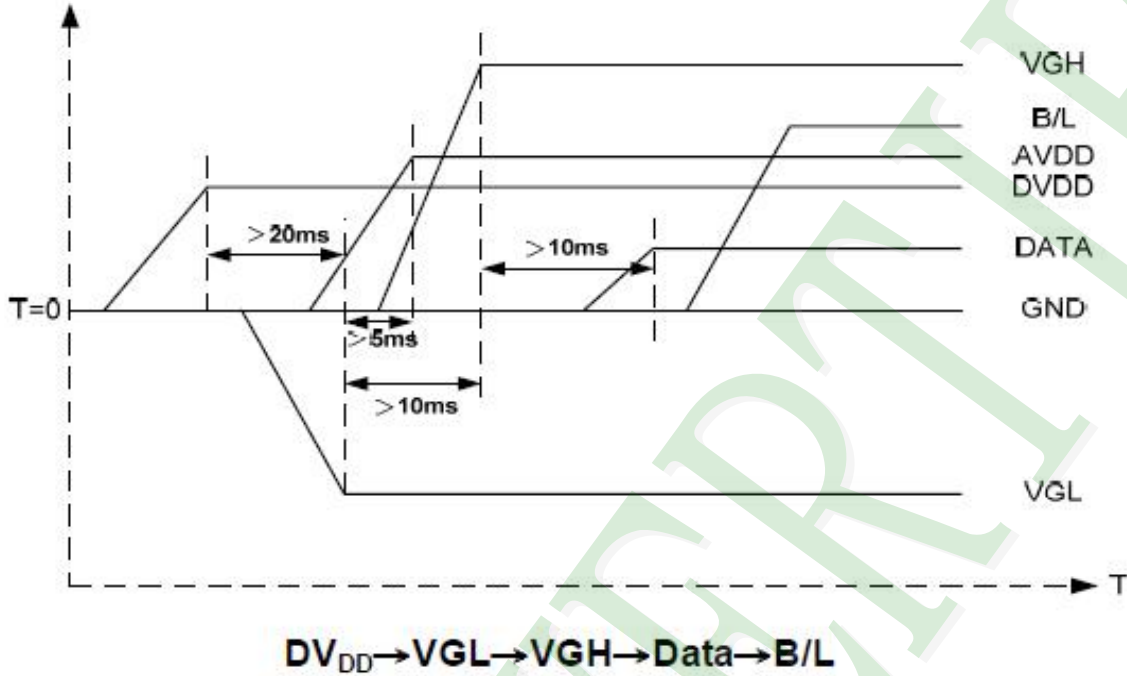

#### b. Power off:

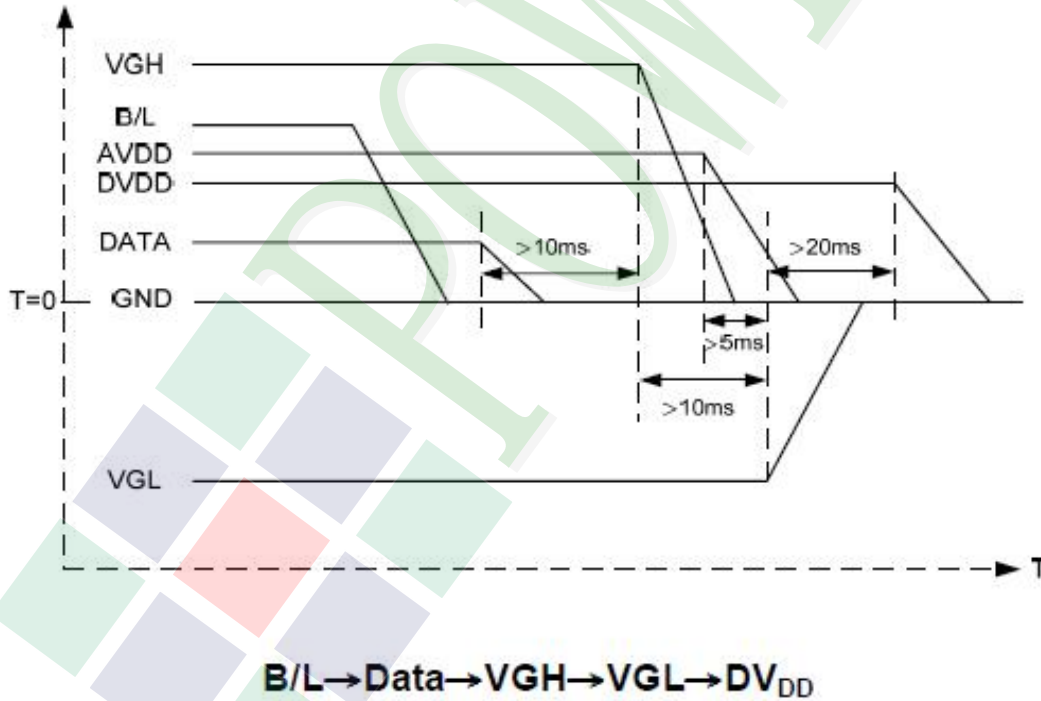

Note: Data include R0~R7, B0~B7, GO~G7, U/D, L/R, DCLK, HS, VS, DE.

### 3. QUALITY ASSURANCE SYSTEM

#### 3.1 Quality Assurance Flow Chart

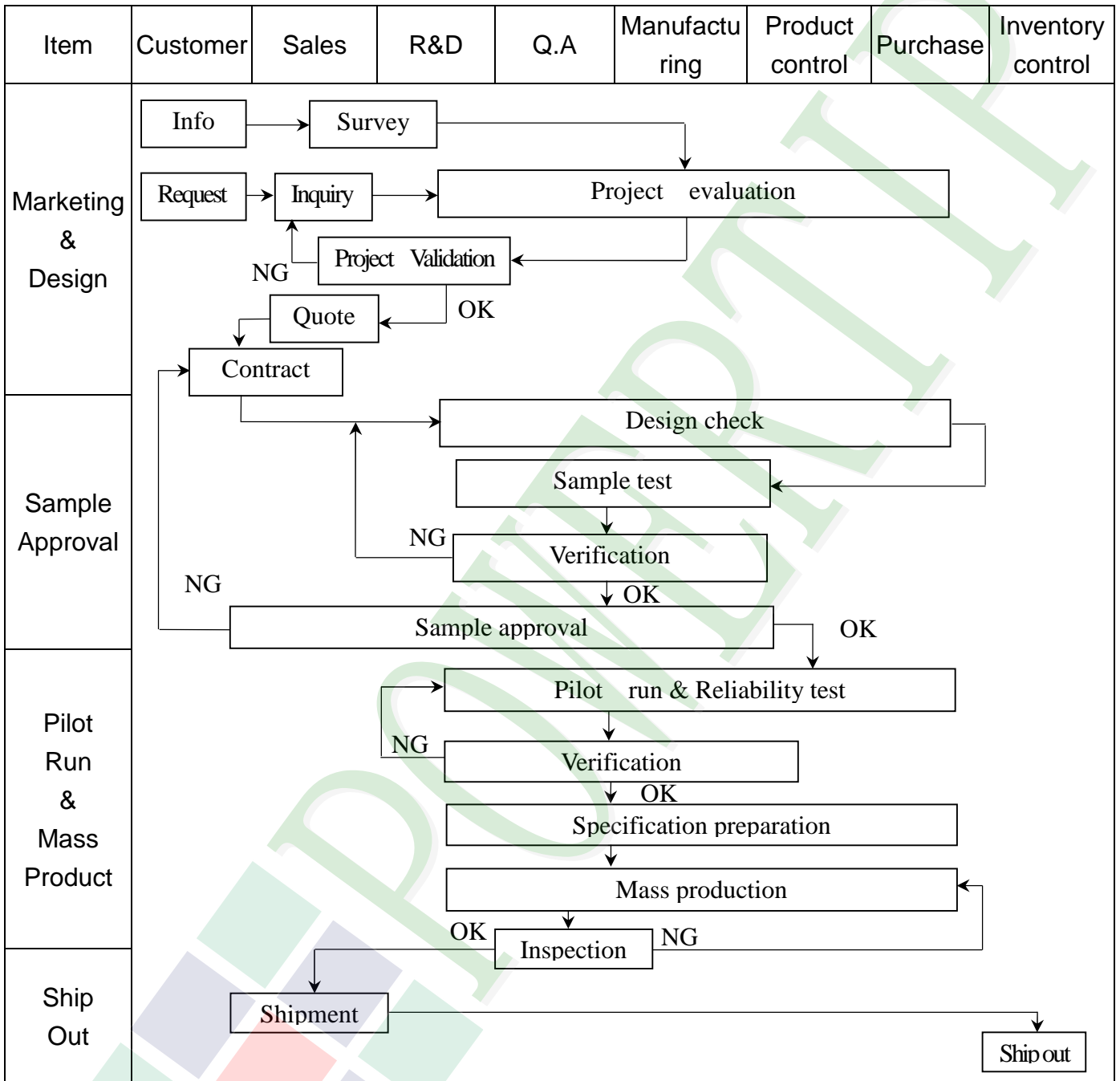

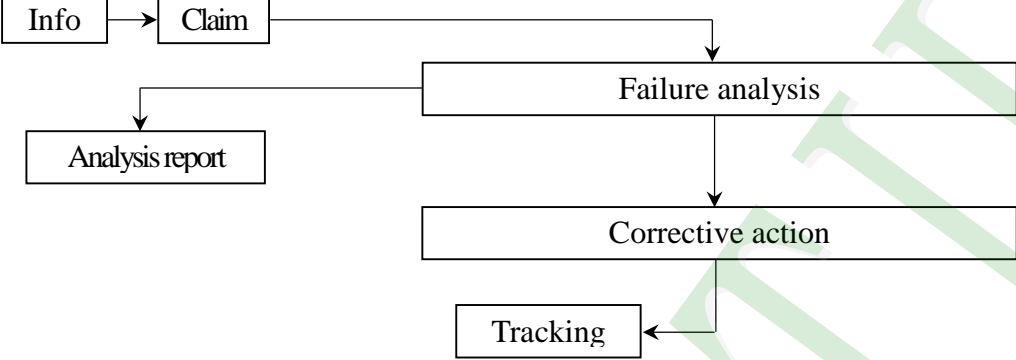
Item	Customer	Sales	R&D	Q.A	Manufacturing	Product control	Purchase	Inventory control
Sales Service	 <pre> graph TD     Info[Info] --&gt; Claim[Claim]     Claim --&gt; Failure[Failure analysis]     Failure --&gt; Analysis[Analysis report]     Failure --&gt; Corrective[Corrective action]     Corrective --&gt; Tracking[Tracking]           </pre>							
Q.A Activity	1. ISO 9001 Maintenance Activities 3. Equipment calibration 5. Standardization Management				2. Process improvement proposal 4. Education And Training Activities			

### 3.2 Inspection Specification

- ◆ Scope : The document shall be applied to TFT-LCD Module for 3.5" ~10" (Ver:B01).
- ◆ Inspection Standard : MIL-STD-105E Table Normal Inspection Single Sampling Level II.
- ◆ Equipment : Gauge 、 MIL-STD 、 Powertip Tester 、 Sample
- ◆ Defect Level : Major Defect AQL : 0.4 ; Minor Defect AQL : 1.5
- ◆ OUT Going Defect Level : Sampling.
- ◆ Standard of the product appearance test :

a. Manner of appearance test :

- (1). The test best be under 20W×2 fluorescent light , and distance of view must be at 30 cm.
- (2). The test direction is base on about around 45° of vertical line.

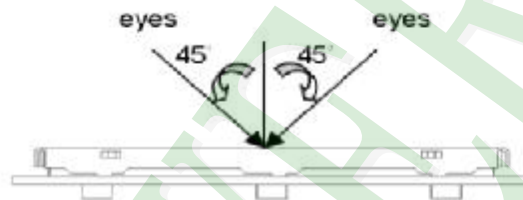

(3). Definition of area.

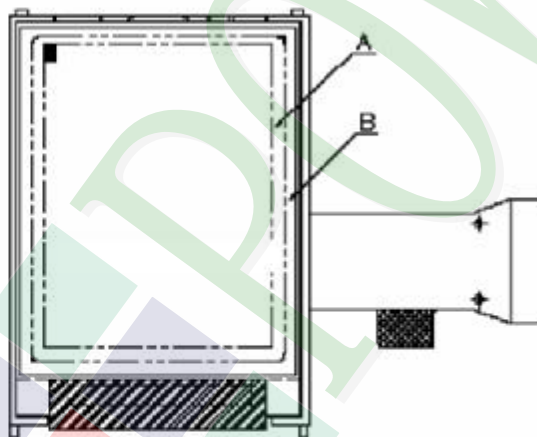

*A* area : viewing area

*B* area : Outside of viewing area

(4). Standard of inspection : (Unit : mm)



◆ Specification For TFT-LCD Module 3.5" ~ 10" :

(Ver.B01)

NO	Item	Criterion	Level										
01	Product condition	1. 1 The part number is inconsistent with work order of production.	Major										
		1. 2 Mixed product types.	Major										
		1. 3 Assembled in inverse direction.	Major										
02	Quantity	2. 1 The quantity is inconsistent with work order of production.	Major										
03	Outline dimension	3. 1 Product dimension and structure must conform to structure diagram.	Major										
		4. 1 Missing line character and icon.	Major										
04	Electrical Testing	4. 2 No function or no display.	Major										
		4. 3 Display malfunction.	Major										
		4. 4 LCD viewing angle defect.	Major										
		4. 5 Current consumption exceeds product specifications.	Major										
05	Dot defect (Bright dot 、 Dark dot)  On -display	<table border="1"> <thead> <tr> <th>Item</th> <th>Acceptance (Q'ty)</th> </tr> </thead> <tbody> <tr> <td>Bright Dot</td> <td><math>\leq 4</math></td> </tr> <tr> <td>Dark Dot</td> <td><math>\leq 5</math></td> </tr> <tr> <td>Joint Dot</td> <td><math>\leq 3</math></td> </tr> <tr> <td>Total</td> <td><math>\leq 7</math></td> </tr> </tbody> </table>	Item	Acceptance (Q'ty)	Bright Dot	$\leq 4$	Dark Dot	$\leq 5$	Joint Dot	$\leq 3$	Total	$\leq 7$	Minor
		Item	Acceptance (Q'ty)										
		Bright Dot	$\leq 4$										
		Dark Dot	$\leq 5$										
		Joint Dot	$\leq 3$										
Total	$\leq 7$												
5. 1 Inspection pattern : full white , full black , Red , Green and blue screens.													
5. 2 It is defined as dot defect if defect area $> 1/2$ dot.													
5. 3 The distance between two dot defect $\geq 5$ mm.													





◆ Specification For TFT-LCD Module 3.5" ~10" :

(Ver.B01)

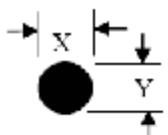
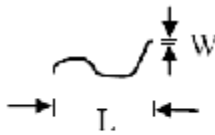
NO	Item	Criterion	Level																						
06	<p>Black or white dot · scratch · contamination</p> <p>Round type</p>  <p><math>\Phi = (x + y) / 2</math></p> <p>Line type</p> 	<p>6.1 Round type ( Non-display or display) :</p> <table border="1"> <thead> <tr> <th rowspan="2">Dimension (diameter : <math>\Phi</math>)</th> <th colspan="2">Acceptance (Q'ty)</th> </tr> <tr> <th>A area</th> <th>B area</th> </tr> </thead> <tbody> <tr> <td><math>\Phi \leq 0.25</math></td> <td colspan="2">Ignore</td> </tr> <tr> <td><math>0.25 &lt; \Phi \leq 0.50</math></td> <td>5</td> <td rowspan="2">Ignore</td> </tr> <tr> <td><math>\Phi &gt; 0.50</math></td> <td>0</td> </tr> <tr> <td><b>Total</b></td> <td colspan="2">5</td> </tr> </tbody> </table>	Dimension (diameter : $\Phi$ )	Acceptance (Q'ty)		A area	B area	$\Phi \leq 0.25$	Ignore		$0.25 < \Phi \leq 0.50$	5	Ignore	$\Phi > 0.50$	0	<b>Total</b>	5		Minor						
		Dimension (diameter : $\Phi$ )		Acceptance (Q'ty)																					
A area	B area																								
$\Phi \leq 0.25$	Ignore																								
$0.25 < \Phi \leq 0.50$	5	Ignore																							
$\Phi > 0.50$	0																								
<b>Total</b>	5																								
<p>6.2 Line type( Non-display or display) :</p> <table border="1"> <thead> <tr> <th rowspan="2">Length (L)</th> <th rowspan="2">Width (W)</th> <th colspan="2">Acceptance (Q'ty)</th> </tr> <tr> <th>A area</th> <th>B area</th> </tr> </thead> <tbody> <tr> <td>--</td> <td><math>W \leq 0.03</math></td> <td colspan="2">Ignore</td> </tr> <tr> <td><math>L \leq 10.0</math></td> <td><math>0.03 &lt; W \leq 0.05</math></td> <td>4</td> <td rowspan="2">Ignore</td> </tr> <tr> <td><math>L \leq 5.0</math></td> <td><math>0.05 &lt; W \leq 0.10</math></td> <td>2</td> </tr> <tr> <td>--</td> <td><math>W &gt; 0.10</math></td> <td colspan="2">As round type</td> </tr> <tr> <td><b>Total</b></td> <td colspan="2">5</td> <td></td> </tr> </tbody> </table>	Length (L)	Width (W)	Acceptance (Q'ty)		A area	B area	--	$W \leq 0.03$	Ignore		$L \leq 10.0$	$0.03 < W \leq 0.05$	4	Ignore	$L \leq 5.0$	$0.05 < W \leq 0.10$	2	--	$W > 0.10$	As round type		<b>Total</b>	5		
Length (L)			Width (W)	Acceptance (Q'ty)																					
	A area	B area																							
--	$W \leq 0.03$	Ignore																							
$L \leq 10.0$	$0.03 < W \leq 0.05$	4	Ignore																						
$L \leq 5.0$	$0.05 < W \leq 0.10$	2																							
--	$W > 0.10$	As round type																							
<b>Total</b>	5																								
07	Polarizer Bubble	<table border="1"> <thead> <tr> <th rowspan="2">Dimension (diameter : <math>\Phi</math>)</th> <th colspan="2">Acceptance (Q'ty)</th> </tr> <tr> <th>A area</th> <th>B area</th> </tr> </thead> <tbody> <tr> <td><math>\Phi \leq 0.25</math></td> <td colspan="2">Ignore</td> </tr> <tr> <td><math>0.25 &lt; \Phi \leq 0.50</math></td> <td>4</td> <td rowspan="2">Ignore</td> </tr> <tr> <td><math>0.50 &lt; \Phi \leq 0.80</math></td> <td>1</td> </tr> <tr> <td><math>\Phi &gt; 0.80</math></td> <td>0</td> <td></td> </tr> <tr> <td><b>Total</b></td> <td colspan="2">5</td> </tr> </tbody> </table>	Dimension (diameter : $\Phi$ )	Acceptance (Q'ty)		A area	B area	$\Phi \leq 0.25$	Ignore		$0.25 < \Phi \leq 0.50$	4	Ignore	$0.50 < \Phi \leq 0.80$	1	$\Phi > 0.80$	0		<b>Total</b>	5		Minor			
Dimension (diameter : $\Phi$ )	Acceptance (Q'ty)																								
	A area	B area																							
$\Phi \leq 0.25$	Ignore																								
$0.25 < \Phi \leq 0.50$	4	Ignore																							
$0.50 < \Phi \leq 0.80$	1																								
$\Phi > 0.80$	0																								
<b>Total</b>	5																								

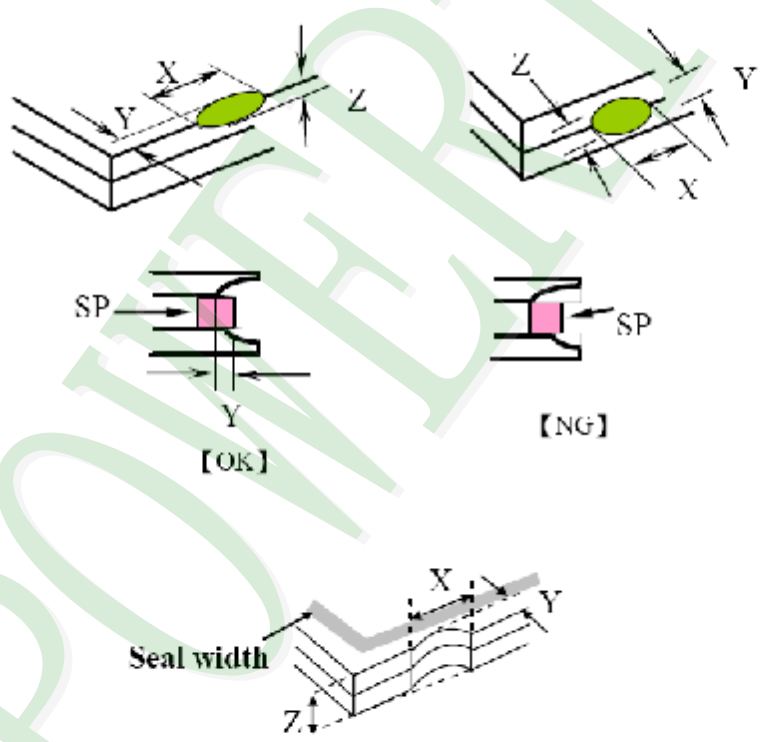

NO	Item	Criterion	Level						
08	The crack of glass	<p><b>Symbols :</b></p> <p><b>X :</b> The length of crack  <b>Z :</b> The thickness of crack  <b>t :</b> The thickness of glass</p> <p><b>Y :</b> The width of crack.  <b>W :</b> terminal length  <b>a :</b> LCD side length</p>	Minor						
		<p>8.1 General glass chip :</p> <p>8.1.1 Chip on panel surface and crack between panels:</p>  <table border="1" data-bbox="542 1545 1340 1836"> <thead> <tr> <th>X</th> <th>Y</th> <th>Z</th> </tr> </thead> <tbody> <tr> <td><math>\leq a</math></td> <td>Crack can't enter viewing area</td> <td><math>\leq 1/2 t</math></td> </tr> <tr> <td><math>\leq a</math></td> <td>Crack can't exceed the half of SP width.</td> <td><math>1/2 t &lt; Z \leq 2 t</math></td> </tr> </tbody> </table>		X	Y	Z	$\leq a$	Crack can't enter viewing area	$\leq 1/2 t$
X	Y	Z							
$\leq a$	Crack can't enter viewing area	$\leq 1/2 t$							
$\leq a$	Crack can't exceed the half of SP width.	$1/2 t < Z \leq 2 t$							

**◆ Specification For TFT-LCD Module 3.5" ~10" :**
**(Ver.B01)**

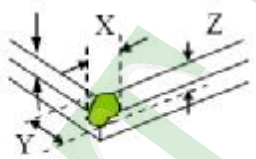
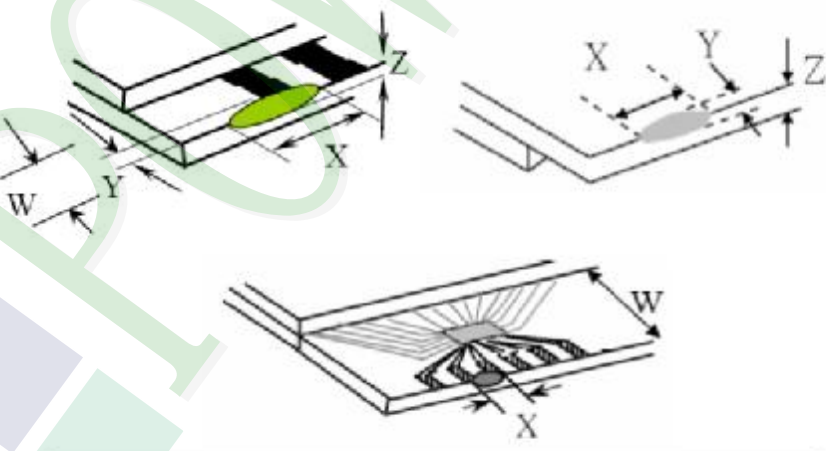
NO	Item	Criterion	Level												
08	The crack of glass	<p><b>Symbols :</b></p> <p><b>X :</b> The length of crack  <b>Z :</b> The thickness of crack  <b>t :</b> The thickness of glass</p> <p><b>Y :</b> The width of crack.  <b>W :</b> terminal length  <b>a :</b> LCD side length</p> <hr/> <p>8.1.2 Corner crack :</p>  <table border="1" data-bbox="528 757 1332 1048"> <thead> <tr> <th>X</th> <th>Y</th> <th>Z</th> </tr> </thead> <tbody> <tr> <td><math>\leq 1/5 a</math></td> <td>Crack can't enter viewing area</td> <td><math>Z \leq 1/2 t</math></td> </tr> <tr> <td><math>\leq 1/5 a</math></td> <td>Crack can't exceed the half of SP width.</td> <td><math>1/2 t &lt; Z \leq 2 t</math></td> </tr> </tbody> </table>	X	Y	Z	$\leq 1/5 a$	Crack can't enter viewing area	$Z \leq 1/2 t$	$\leq 1/5 a$	Crack can't exceed the half of SP width.	$1/2 t < Z \leq 2 t$				
		X	Y	Z											
$\leq 1/5 a$	Crack can't enter viewing area	$Z \leq 1/2 t$													
$\leq 1/5 a$	Crack can't exceed the half of SP width.	$1/2 t < Z \leq 2 t$													
		<p>8.2 Protrusion over terminal :</p> <p>8.2.1 Chip on electrode pad :</p>  <table border="1" data-bbox="563 1675 1343 1848"> <thead> <tr> <th></th> <th>X</th> <th>Y</th> <th>Z</th> </tr> </thead> <tbody> <tr> <td>Front</td> <td><math>\leq a</math></td> <td><math>\leq 1/2 W</math></td> <td><math>\leq t</math></td> </tr> <tr> <td>Back</td> <td><math>\leq a</math></td> <td><math>\leq W</math></td> <td><math>\leq 1/2 t</math></td> </tr> </tbody> </table>		X	Y	Z	Front	$\leq a$	$\leq 1/2 W$	$\leq t$	Back	$\leq a$	$\leq W$	$\leq 1/2 t$	Minor
	X	Y	Z												
Front	$\leq a$	$\leq 1/2 W$	$\leq t$												
Back	$\leq a$	$\leq W$	$\leq 1/2 t$												

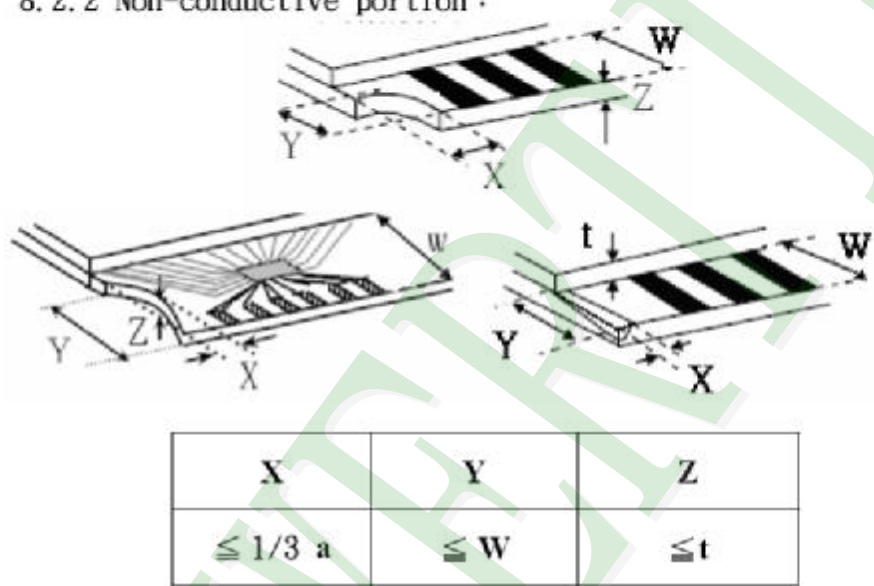
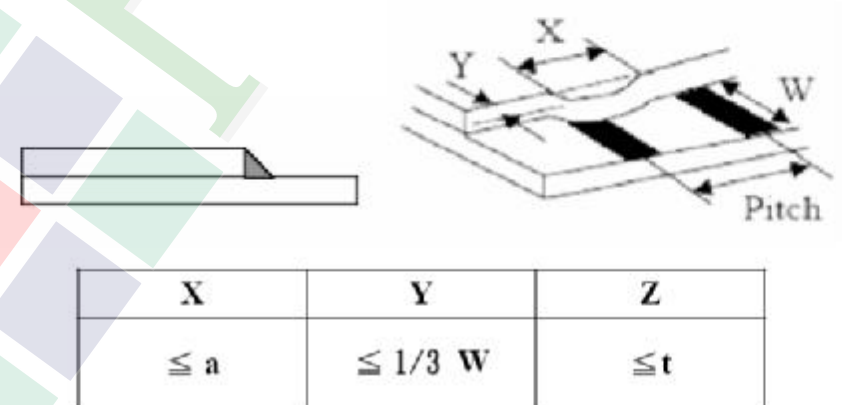
NO	Item	Criterion	Level
08	The crack of glass	<p><b>Symbols :</b></p> <p><b>X :</b> The length of crack  <b>Z :</b> The thickness of crack  <b>t :</b> The thickness of glass</p> <p><b>Y :</b> The width of crack.  <b>W :</b> terminal length  <b>a :</b> LCD side length</p> <hr/> <p>8.2.2 Non-conductive portion :</p>  <p>⊙ If the chipped area touches the ITO terminal, over 2/3 of the ITO must remain and be inspected according to electrode terminal specifications.</p> <p>8.2.3 Glass remain :</p> 	Minor

## 4. RELIABILITY TEST

### 4.1 Reliability Test Condition

(Ver.B01)

NO.	TEST ITEM	TEST CONDITION										
1	High Temperature Storage Test	Keep in +80 ±2°C 96 hrs Surrounding temperature, then storage at normal condition 4hrs.										
2	Low Temperature Storage Test	Keep in -30 ±2°C 96 hrs Surrounding temperature, then storage at normal condition 4hrs.										
3	High Temperature / High Humidity Storage Test	Keep in +60°C / 90% R.H duration for 96 hrs Surrounding temperature, then storage at normal condition 4hrs. (Excluding the polarizer)										
4	Temperature Cycling Storage Test	$\begin{matrix} -30^{\circ}\text{C} \rightarrow & +25^{\circ}\text{C} \rightarrow & +80^{\circ}\text{C} \rightarrow & +25^{\circ}\text{C} \\ (30\text{mins}) & (5\text{mins}) & (30\text{mins}) & (5\text{mins}) \\ \leftarrow & & & \rightarrow \\ & \text{10 Cycle} & & \end{matrix}$ Surrounding temperature, then storage at normal condition 4hrs.										
5	ESD Test	<b>Air Discharge:</b> Apply 2 KV with 5 times Discharge for each polarity +/-										
		<b>Contact Discharge:</b> Apply 250 V with 5 times discharge for each polarity +/-										
		<ol style="list-style-type: none"><li>1. Temperature ambience : 15°C ~ 35°C</li><li>2. Humidity relative : 30% ~ 60%</li><li>3. Energy Storage Capacitance(Cs+Cd) : 150pF±10%</li><li>4. Discharge Resistance(Rd) : 330Ω±10%</li><li>5. Discharge, mode of operation : Single Discharge (time between successive discharges at least 1 sec) (Tolerance if the output voltage indication : ±5%)</li></ol>										
6	Vibration Test (Packaged)	<ol style="list-style-type: none"><li>1. Sine wave 10~55 Hz frequency (1 min)</li><li>2. The amplitude of vibration : 1.5 mm</li><li>3. Each direction (X、Y、Z) duration for 2 Hrs</li></ol>										
7	Drop Test (Packaged)	<table border="1"><thead><tr><th>Packing Weight (Kg)</th><th>Drop Height (cm)</th></tr></thead><tbody><tr><td>0 ~ 45.4</td><td>122</td></tr><tr><td>45.4 ~ 90.8</td><td>76</td></tr><tr><td>90.8 ~ 454</td><td>61</td></tr><tr><td>Over 454</td><td>46</td></tr></tbody></table>	Packing Weight (Kg)	Drop Height (cm)	0 ~ 45.4	122	45.4 ~ 90.8	76	90.8 ~ 454	61	Over 454	46
		Packing Weight (Kg)	Drop Height (cm)									
0 ~ 45.4	122											
45.4 ~ 90.8	76											
90.8 ~ 454	61											
Over 454	46											
		Drop direction : ※1 corner / 3 edges / 6 sides each 1times										

## 5. PRECAUTION RELATING PRODUCT HANDLING

### 5.1 SAFETY

- 5.1.1 If the LCD panel breaks , be careful not to get the liquid crystal to touch your skin.
- 5.1.2 If the liquid crystal touches your skin or clothes , please wash it off immediately by using soap and water.

### 5.2 HANDLING

- 5.2.1 Avoid any strong mechanical shock which can break the glass.
- 5.2.2 Avoid static electricity which can damage the CMOS LSI—When working with the module , be sure to ground your body and any electrical equipment you may be using.
- 5.2.3 Do not remove the panel or frame from the module.
- 5.2.4 The polarizing plate of the display is very fragile. So , please handle it very carefully ,do not touch , push or rub the exposed polarizing with anything harder than an HB pencil lead (glass , tweezers , etc.)
- 5.2.5 Do not wipe the polarizing plate with a dry cloth , as it may easily scratch the surface of plate.
- 5.2.6 Do not touch the display area with bare hands , this will stain the display area.
- 5.2.7 Do not use ketonics solvent & aromatic solvent. Use with a soft cloth soaked with a cleaning naphtha solvent.
- 5.2.8 To control temperature and time of soldering is  $320\pm 10^{\circ}\text{C}$  and 3-5 sec.
- 5.2.9 To avoid liquid (include organic solvent) stained on LCM .

### 5.3 STORAGE

- 5.3.1 Store the panel or module in a dark place where the temperature is  $25^{\circ}\text{C} \pm 5^{\circ}\text{C}$  and the humidity is below 65% RH.
- 5.3.2 Do not place the module near organics solvents or corrosive gases.
- 5.3.3 Do not crush , shake , or jolt the module.

### 5.4 TERMS OF WARRANTY

- 5.4.1 Applicable warrant period  
The period is within thirteen months since the date of shipping out under normal using and storage conditions.
- 5.4.2 Unaccepted responsibility  
This product has been manufactured to your company's specification as a part for use in your company's general electronic products. It is guaranteed to perform according to delivery specifications. For any other use apart from general electronic equipment , we cannot take responsibility if the product is used in nuclear power control equipment , aerospace equipment , fire and security systems or any other applications in which there is a direct risk to human life and where extremely high levels of reliability are required.

A B C D E F G H

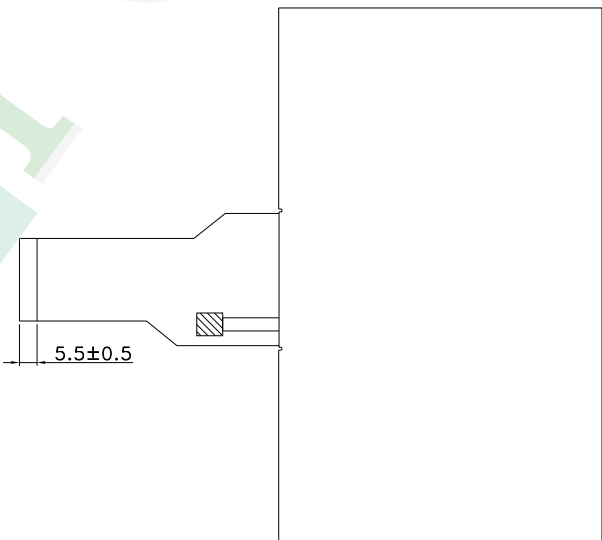
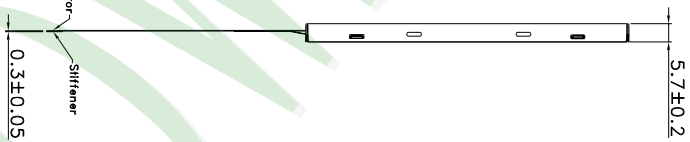
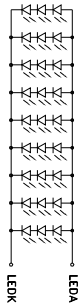
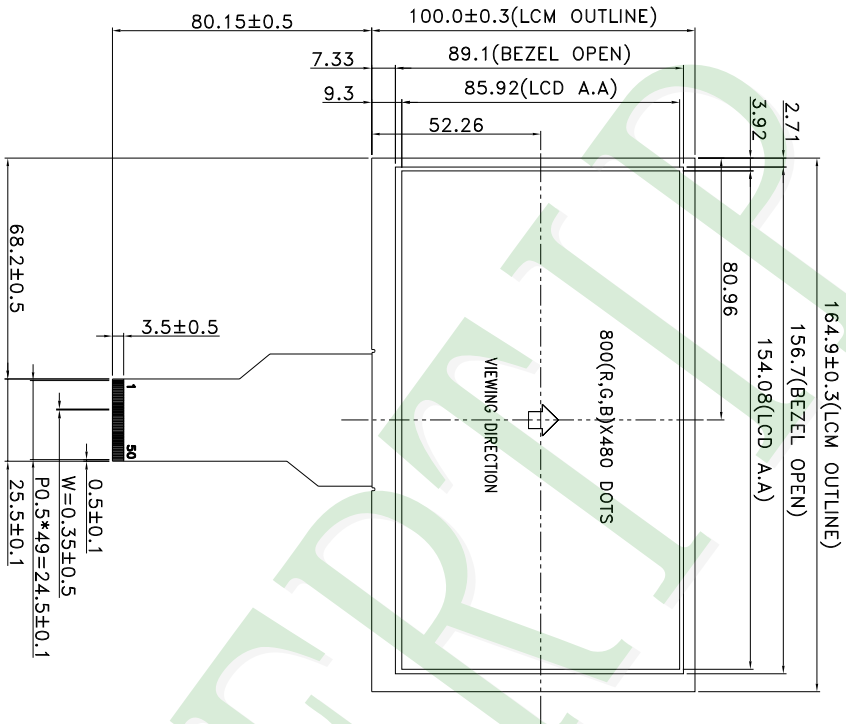

- NOTES:
1. LCD TYPE: TFT LCD
  2. LCD DISPLAY: POSITIVE/TRANSMISSIVE
  3. VIEW DIRECTION: 6 O'CLOCK
  4. The tolerance unless classified  $\pm 0.3\text{mm}$
  5. FPC suggested connector : HIROSE FH12A-50S-0.5H or compatible

PART NO:  
PH800480T013-IDA01

DRAWING NAME :  
JLMD-PH800480T013-IDA01

TITLE:  
LCD MODULE DRAWING



久正光電股份有限公司  
POWER TIP TECHNOLOGY CORPORATION

Design Terry

Check Eddy

Approve Ryan



(3)

Surface

Material

Unit

MM

Scale

FIT

Page

1/1

Quantity

Thickness

63 ~ 280

250 ~ 1000

Precision Level

1 ~ 4

4 ~ 16

16 ~ 63

63 ~ 250

250 ~ 1000

007									
006									
005									
004									
003									
002									
001	NEW DRAWING								
REV		REV BY		REVISER		DATE			



Ver.001	Documents NO. JPKG-PH800480T013-IDA01	LCM包裝規格書 LCM Packaging Specifications	Approve	Check	Contact
			Ryan	Eddy	Terry

1. 包裝材料規格表 (Packaging Material) : (per carton)

No.	Item	Model	Dimensions (mm)	1Pcs Weight	Quantity	Total Weight
1	成品 (1)LCM	PH800480T013-IDA01	164.9 X 100 X 5.7	0.15	66	9.9
2	氣泡袋(2)Bubble Bag	BAG170150BRABA	150 X 120	0.002	66	0.132
3	A8隔板(3)A8 Partition	BX00000000051	245 X 105 X 3	0.0135	72	0.972
4	B8隔板(4)B8 Partition	BX00000000050	295 X 105 X 3	0.0168	12	0.2016
5	氣泡紙(5)Bubble Sheet	BAG280240BWABA	280 X 240	0.006	12	0.144
6	C3-3內盒(6)Product Box	BX31025511AABA	310 X 255 X 116	0.17	6	1.02
7	外紙箱(7)Carton	BX52732536CCBA	527 X 325 X 360	0.83	1	0.83
8						
9						

2. 一整箱總重量 (Total LCD Weight in carton) : 13.2 Kg±10%

3. 單箱數量規格表 (Packaging Specifications and Quantity) :

(1)Quantity Of Spacer : A8隔板 X 12 , B8隔板 X 2

(2)Total LCM quantity in carton : quantity per box 11 x no of boxes 6 = 66

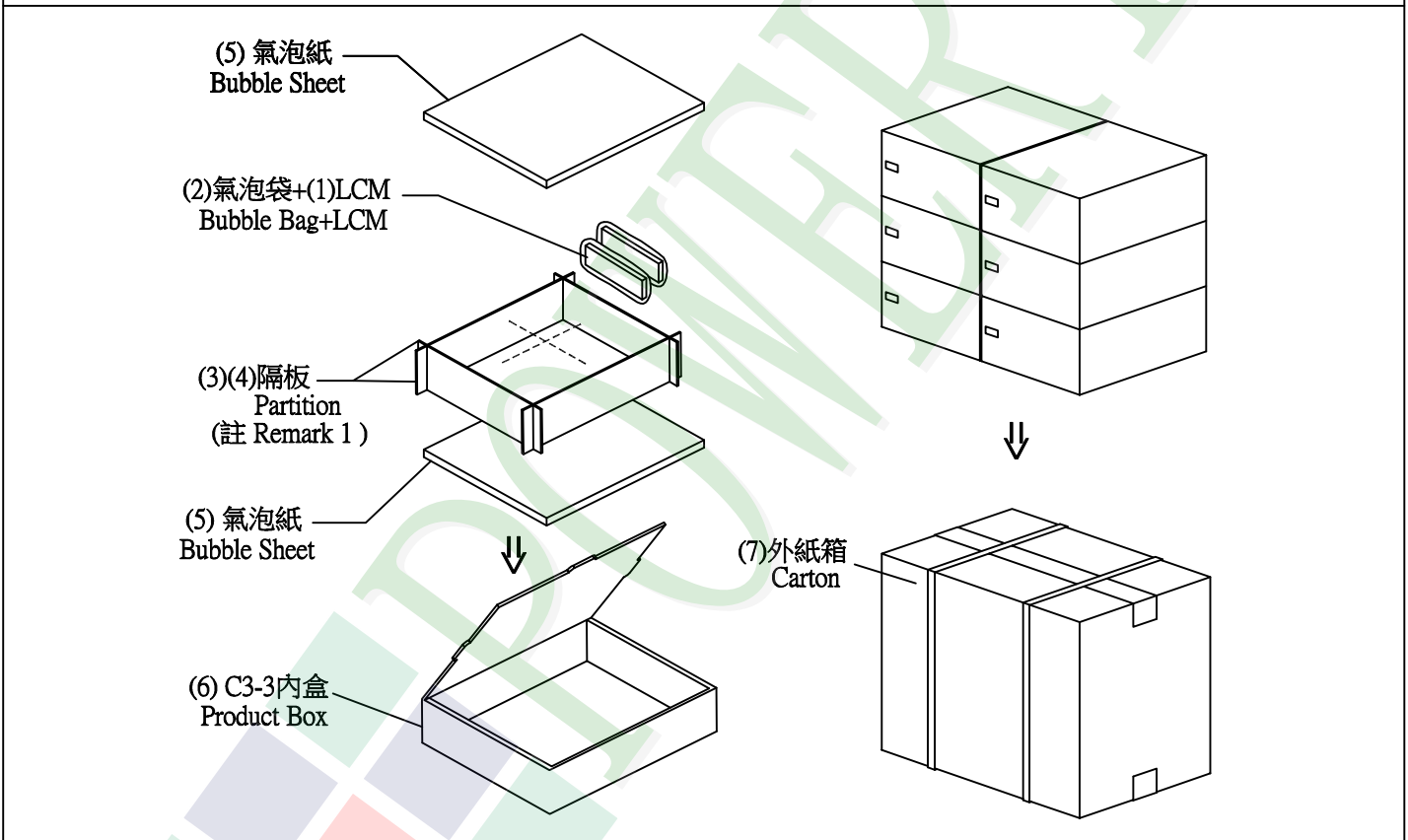

特 記 事 項 (REMARK)

1. LCM排放示意圖(前後間隔不放置):

1. LCM placed as figure showing:  
( First and last slot should be empty)

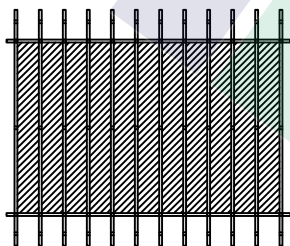

▨ 模組(LCM) X 1pcs.