

Model Name: P850QVN02.1

Issue Date : 2018/05/23

(*) Preliminary Specifications

() Final Specifications

Customer Signature	Date	AUO	Date
Approved By		Approval By PM Director CT Wu	
Note		Reviewed By RD Director Jack SC Hsu	
		Reviewed By Project Leader MingYu Wu	
		Prepared By PM Bryan Chu	

Contents

1.	General Description.....	4
2.	Absolute Maximum Ratings.....	6
3.	Optical Specification	7
4.	Interface Specification.....	10
4.1	Input power.....	10
4.2	Input Connection.....	11
4.3	Input Data Format.....	13
4.3.1	V by one Data mapping	13
4.3.2	Color Input Data Reference	14
5.	Signal Timing Specification	15
5.1	Input Timing.....	15
5.1.1	Timing table	15
5.2	Input interface characteristics	17
5.2.1	V by one	17
5.3	Power Sequence for LCD	20
6.	Backlight Specification.....	21
6.1	Electrical specification	21
6.2	Input Pin Assignment.....	22
6.3	Power Sequence for Backlight.....	25
7.	Mechanical Characteristics.....	26
8.	Reliability Test Items	30
9.	International Standard	31
9.1	Safety	31
9.2	EMC	31
10.	Packing.....	32
10.1	Definition of Label.....	32
10.2	Packing Methods.....	33
10.3	Pallet and Shipment Information	34
11.	Precautions	35
11.1	Mounting Precautions.....	35
11.2	Operating Precautions.....	35
11.3	Operating Condition for Public Information Display.....	36
11.4	Electrostatic Discharge Control.....	36
11.5	Precautions for Strong Light Exposure.....	37
11.6	Storage.....	37
11.7	Handling Precautions for Protection Film.....	37
11.8	Dust Resistance	37

1. General Description

This specification applies to the 54.6 inch Color TFT-LCD Module P850QVN02.1. This LCD module has a TFT active matrix type liquid crystal panel 3840 x 2160 pixels, and diagonal size of 54.6 inch. This module supports 3840 x 2160 mode. Each pixel is divided into Red, Green and Blue sub-pixels or dots which are arranged in vertical stripes. Gray scale or the brightness of the sub-pixel color is determined with a 10-bit gray scale signal for each dot.

P850QVN02.1 has been designed to apply the 10-bit 2 channel LVDS interface method. It is intended to support displays where high brightness, wide viewing angle, high color saturation, and high color depth are very important.

* General Information

Items	Specification	Unit	Note
Active Screen Size	85	inch	
Display Area	1872.0(H) x 1053.0(V)	mm	
Outline Dimension	1910.0(H) x 1091.0(V) x 61.4(D)	mm	D: front bezel to T-con cover
Driver Element	a-Si TFT active matrix		
Bezel Opening	1876(H) x 1057(V)	mm	
Display Colors	8bit + FRC (1.07 billion)	Colors	8 bit/10 bit selectable
Number of Pixels	3840x2160	Pixel	
Pixel Pitch	0.4875 (H) x 0.4875 (W)	mm	
Pixel Arrangement	RGB vertical stripe		
Display Operation Mode	Normally Black		
Surface Treatment	Anti-glare, 3H		Reflectance $\leq 1.45\%$
Rotate Function	Unachievable		Note 1
Display Orientation	Portrait/Landscape Enabled		Note 2

Note 1: Rotate Function refers to LCD display could be able to rotate. This function does not work in this model.

Note 2:

- (1) Landscape Mode: The default placement is T-Con Side on the lower side and the image is shown upright via viewing from the front.
- (2) Portrait Mode: The default placement is that T-Con side has to be placed on the left side via viewing from the front.

Landscape (Front view)

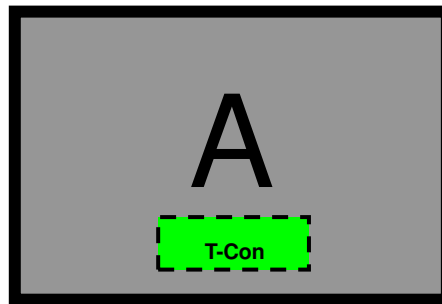

Portrait (Front view)

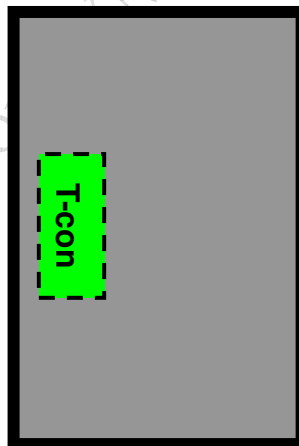

2. Absolute Maximum Ratings

The followings are maximum values which, if exceeded, may cause faulty operation or damage to the unit

Item	Symbol	Min	Max	Unit	Conditions
Logic/LCD Drive Voltage	V _{DD}	-0.3	14	[Volt]	Note 1
Input Voltage of Signal	V _{in}	-0.3	4	[Volt]	Note 1
Operating Temperature	TOP	0	+50	[°C]	Note 2
Operating Humidity	HOP	10	90	[%RH]	Note 2
Storage Temperature	TST	-20	+60	[°C]	Note 2
Storage Humidity	HST	10	90	[%RH]	Note 2
Panel Surface Temperature	PST		65	[°C]	Note 3

Note 1: Duration:50 msec.

Note 2 : Maximum Wet-Bulb should be 39°C and No condensation.

The relative humidity must not exceed 90% non-condensing at temperatures of 40°C or less. At temperatures greater than 40°C, the wet bulb temperature must not exceed 39°C.

Note 3: Surface temperature is measured at 50°C Dry condition

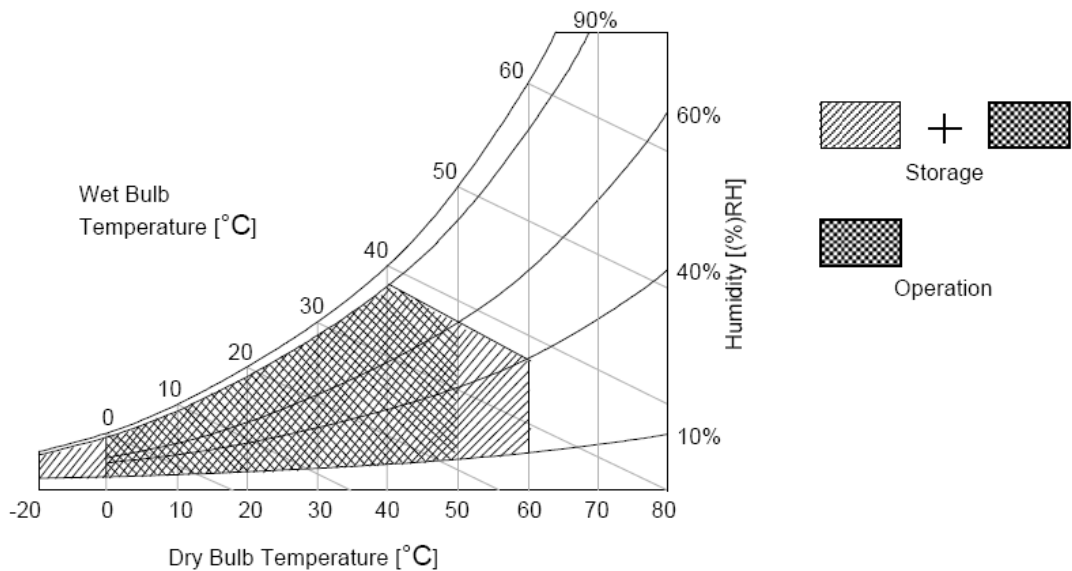

3. Optical Specification

Optical characteristics are determined after the unit has been 'ON' and stable for approximately 45 minutes in a dark environment at 25°C. The values specified are at an approximate distance 500 mm from the LCD surface at a viewing angle of φ and θ equal to 0°.

Fig.1 presents additional information concerning the measurement equipment and method.

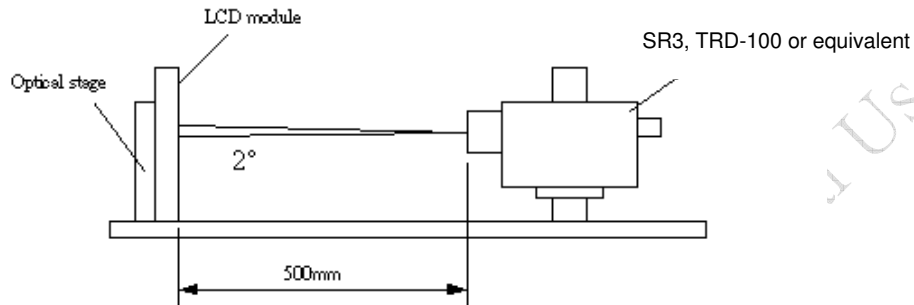

Parameter	Symbol	Values			Unit	Notes
		Min.	Typ.	Max		
Contrast Ratio	CR	3200	4000	--		1
Surface Luminance (White)	L_{WH}	560	700	--	cd/m ²	2
Luminance Variation	$\delta_{WHITE(9P)}$	--	--	1.33		3
Response Time (G to G)	T_{γ}	--	8.5	16	ms	4
Color Gamut	NTSC		88		%	
Color Coordinates						
	Red	R_x	Typ.-0.03	0.670	Typ.+0.03	
		R_y		0.313		
	Green	G_x		0.267		
		G_y		0.655		
	Blue	B_x		0.152		
		B_y		0.056		
	White	W_x		0.280		
	W_y	0.290				
Viewing Angle						
	x axis, right($\varphi=0^\circ$)	θ_r	--	89	--	degree
	x axis, left($\varphi=180^\circ$)	θ_l	--	89	--	degree
	y axis, up($\varphi=90^\circ$)	θ_u	--	89	--	degree
	y axis, down ($\varphi=270^\circ$)	θ_d	--	89	--	degree

Note:

1. Contrast Ratio (CR) is defined mathematically as:

$$\text{Contrast Ratio} = \frac{\text{Surface Luminance of } L_{on5}}{\text{Surface Luminance of } L_{off5}}$$

2. Surface luminance is luminance value at point 5 across the LCD surface 50cm from the surface with all pixels displaying white. From more information see FIG 2. LED current I_F = typical value (without driver board), LED input $V_{DDB} = 24V$, I_{DDB} = Typical value (with driver board), $L_{WH} = L_{on5}$ where L_{on5} is the luminance with all pixels displaying white at center 5 location.

3. The variation in surface luminance, δ_{WHITE} is defined (center of Screen) as:

$$\delta_{WHITE(9P)} = \frac{\text{Maximum}(L_{on1}, L_{on2}, \dots, L_{on9})}{\text{Minimum}(L_{on1}, L_{on2}, \dots, L_{on9})}$$

4. Response time T_γ is the average time required for display transition by switching the input signal for five luminance ratio (0%,25%,50%,75%,100% brightness matrix) and is based on Frame rate = 60Hz to optimize.

Measured Response Time		Target				
		0%	25%	50%	75%	100%
Start	0%		0% to 25%	0% to 50%	0% to 75%	0% to 100%
	25%	25% to 0%		25% to 50%	25% to 75%	25% to 100%
	50%	50% to 0%	50% to 25%		50% to 75%	50% to 100%
	75%	75% to 0%	75% to 25%	75% to 50%		75% to 100%
	100%	100% to 0%	100% to 25%	100% to 50%	100% to 75%	

T_γ is determined by 10% to 90% brightness difference of rising or falling period. (As illustrated)

The response time is defined as the following figure and shall be measured by switching the input signal for "any level of gray(bright)" and "any level of gray(dark)".

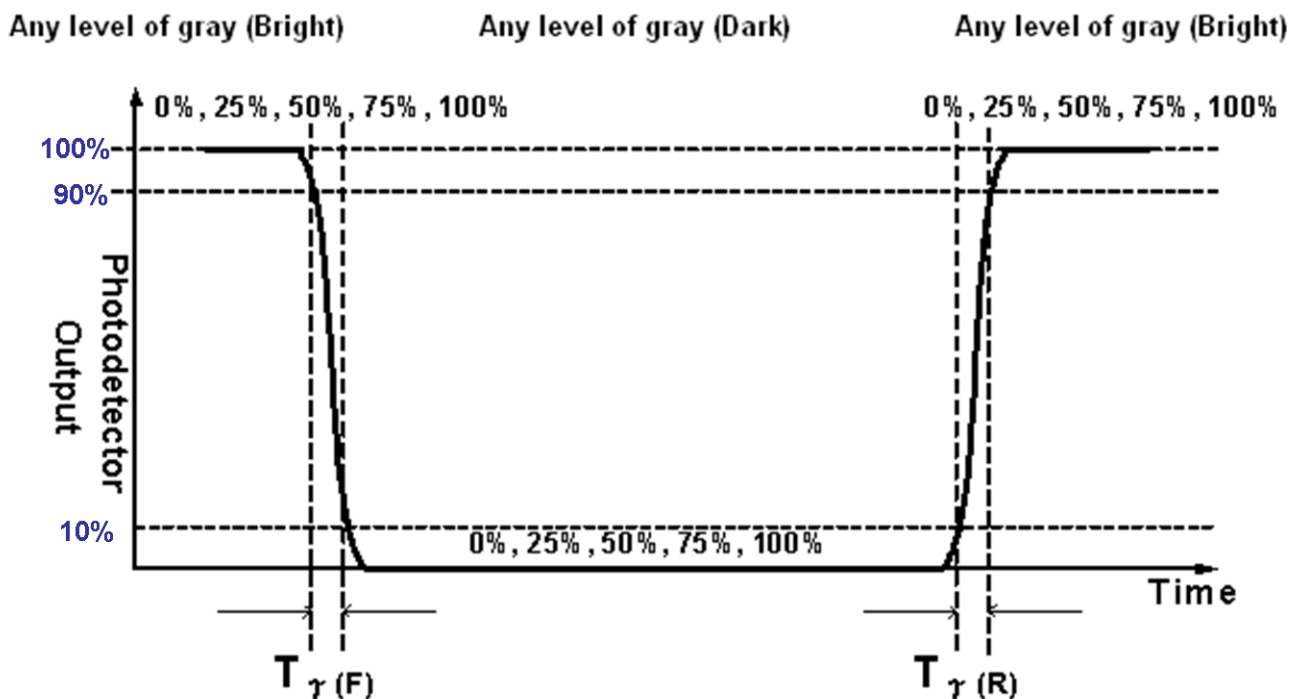
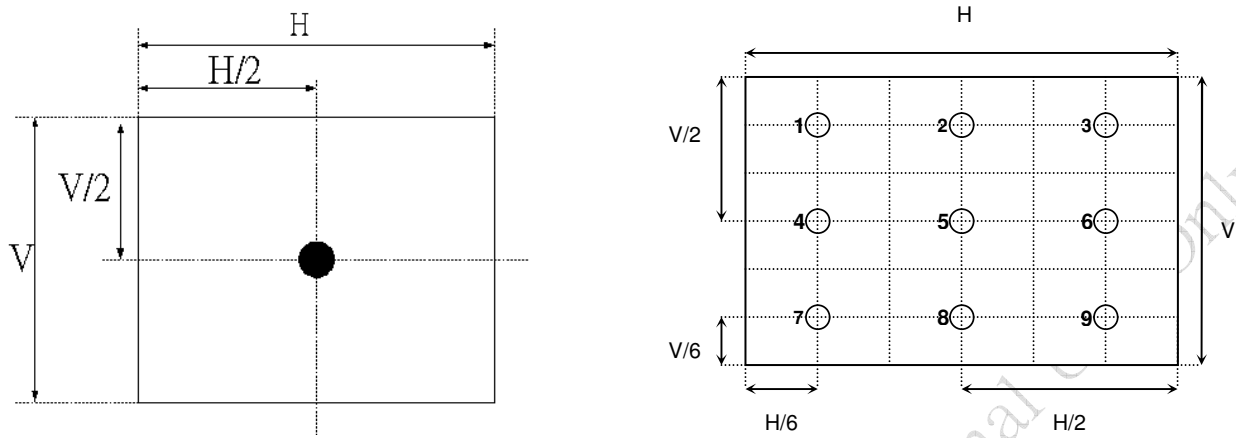
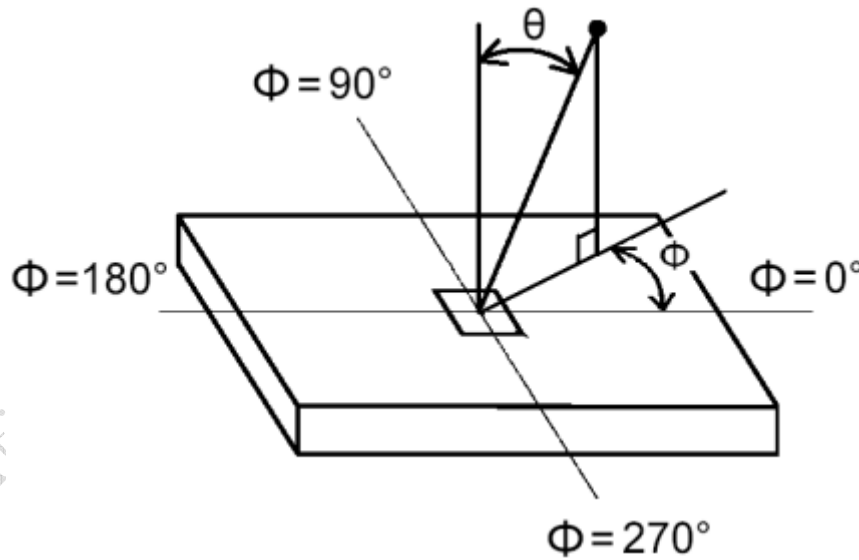

FIG. 2 Luminance



5. Viewing angle is the angle at which the contrast ratio is greater than 10. The angles are determined for the horizontal or x axis and the vertical or y axis with respect to the z axis which is normal to the LCD surface. For more information see FIG3.

FIG.3 Viewing Angle



4. Interface Specification

4.1 Input power

The P550HVN06.4 module requires 2 power inputs(12-pin & 14-pin) which are employed to power the LCD electronics and to drive the TFT array and liquid crystal.

Item	Symbol	Min.	Typ.	Max	Unit	Note
Power Supply Input Voltage	V_{DD}	10.8	12	13.2	V	1
Power Supply Input Current	Black pattern	-	1.38	1.66	A	2
	White pattern	-	1.28	1.54	A	
	H-strip pattern	-	2.75	3.3	A	
Power Consumption	Black pattern	-	16.56	19.87	Watt	
	White pattern	-	15.36	18.43	Watt	
	H-strip pattern	-	33	39.6	Watt	
Inrush Current	I_{RUSH}	--	--	7	A	3

Note1. The ripple voltage should be fewer than 5% of VDD.

Note2. Test Condition:

- (1) $V_{DD} = 12.0V$, (2) $F_v = 60Hz$, (3) $F_{clk} = 74.25MHz$, (4) Temperature = 25 °C
- (5) Power dissipation check pattern. (Only for power design)

a. Black pattern

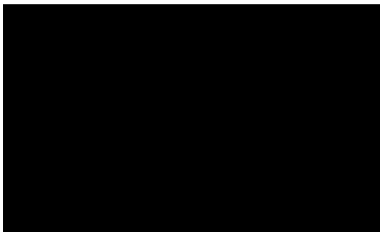

b. White pattern



c. H-Strip pattern

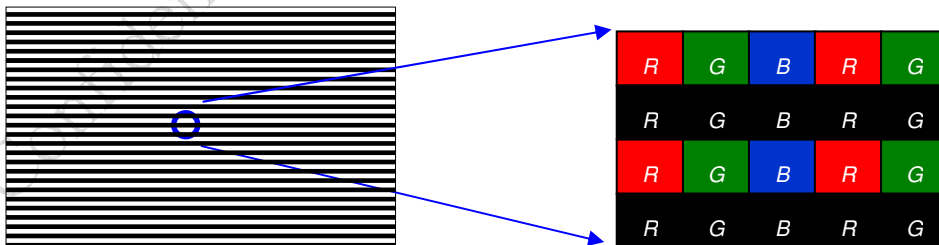

Note3. Measurement condition : Rising time = 400us

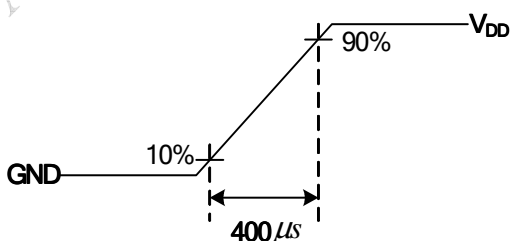

4.2 Input Connection

■ LCD connector: (JAE) SJ11346-FI-RTE51SZ-HF

PIN	Symbol	Description	Note	PIN	Symbol	Description	Note
1	V _{DD}	Power Supply Input Voltage		26	LOCKN	Vx1 LOCK	
2	V _{DD}	Power Supply Input Voltage		27	GND	Ground	
3	V _{DD}	Power Supply Input Voltage		28	RX0N	Vx1 lane 0	
4	V _{DD}	Power Supply Input Voltage		29	RX0P	Vx1 lane 0	
5	V _{DD}	Power Supply Input Voltage		30	GND	Ground	
6	V _{DD}	Power Supply Input Voltage		31	RX1N	Vx1 lane 1	
7	V _{DD}	Power Supply Input Voltage		32	Rx1P	Vx1 lane 1	
8	V _{DD}	Power Supply Input Voltage		33	GND	Ground	
9	N.C.	No connection	2	34	RX2N	Vx1 lane 2	
10	GND	Ground		35	RX2P	Vx1 lane2	
11	GND	Ground		36	GND	Ground	
12	GND	Ground		37	RX3N	Vx1 lane 3	
13	GND	Ground		38	RX3P	Vx1 lane 3	
14	GND	Ground		39	GND	Ground	
15	LDC	Local Dimming Control Open / High(3.3v): enable Low: disable	3	40	RX4N	Vx1 lane 4	
16	N.C.	No connection	2	41	RX4P	Vx1 lane 4	
17	N.C.	No connection	2	42	GND	Ground	
18	N.C.	No connection	2	43	RX5N	Vx1 lane 5	
19	N.C.	No connection	2	44	RX5P	Vx1 lane 5	
20	N.C.	No connection	2	45	GND	Ground	
21	N.C.	No connection	2	46	RX6N	Vx1 lane 6	
22	N.C.	No connection	2	47	RX6P	Vx1 lane 6	
23	N.C.	No connection	2	48	GND	Ground	
24	GND	Ground		49	RX7N	Vx1 lane 7	
25	HTPDN	Vx1 HTPDN		50	RX7P	Vx1 lane 7	
				51	GND	Ground	

Note1. Pin number start from the left side as the following figure.

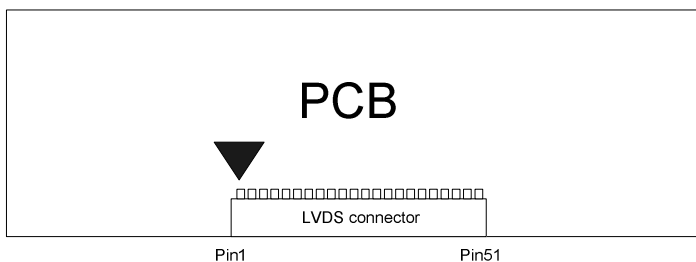

Note2. Please leave this pin unoccupied. It can not be connected by any signal (Low/GND/High).

Note3. Input control signal threshold voltage definition

Item	Symbol	Min.	Typ.	Max.	Unit
Input High Threshold Voltage	VIH	2.7	-	3.6	V
Input Low Threshold Voltage	VIL	0	-	0.6	V

AUO Confidential For SYMMETRON Internal Use Only

4.3 Input Data Format

4.3.1 V by one Data mapping

Mode	Packer input & Unpacker output		30bpp RGB /YCbCr444 (10bit)
4byte mode	Byte0	D[0]	R/Cr[2]
		D[1]	R/Cr[3]
		D[2]	R/Cr[4]
		D[3]	R/Cr[5]
		D[4]	R/Cr[6]
		D[5]	R/Cr[7]
		D[6]	R/Cr[8]
		D[7]	R/Cr[9]
	Byte1	D[8]	G/Y[2]
		D[9]	G/Y[3]
		D[10]	G/Y[4]
		D[11]	G/Y[5]
		D[12]	G/Y[6]
		D[13]	G/Y[7]
		D[14]	G/Y[8]
		D[15]	G/Y[9]
	Byte2	D[16]	B/Cb[2]
		D[17]	B/Cb[3]
		D[18]	B/Cb[4]
		D[19]	B/Cb[5]
		D[20]	B/Cb[6]
		D[21]	B/Cb[7]
		D[22]	B/Cb[8]
		D[23]	B/Cb[9]
	Byte3	D[24]	--
		D[25]	--
		D[26]	B/Cb[0]
		D[27]	B/Cb[1]
		D[28]	G/Y[0]
		D[29]	G/Y[1]
		D[30]	R/Cr[0]
		D[31]	R/Cr[1]

4.3.2 Color Input Data Reference

The brightness of each primary color (red, green and blue) is based on the 10 bit gray scale data input for the color; the higher the binary input, the brighter the color. The table below provides a reference for color versus data input.

COLOR DATA REFERENCE

Color		Input Color Data																													
		RED										GREEN										BLUE									
		MSB					LSB					MSB					LSB					MSB				LSB					
		R9	R8	R7	R6	R5	R4	R3	R2	R1	R0	G9	G8	G7	G6	G5	G4	G3	G2	G1	G0	B9	B8	B7	B6	B5	B4	B3	B2	B1	B0
Basic Color	Black	0	0	0	0	0	0	0	0	0	0	0	0	0	0	0	0	0	0	0	0	0	0	0	0	0	0	0	0	0	0
	Red(1023)	1	1	1	1	1	1	1	1	1	1	0	0	0	0	0	0	0	0	0	0	0	0	0	0	0	0	0	0	0	0
	Green(1023)	0	0	0	0	0	0	0	0	0	0	1	1	1	1	1	1	1	1	1	1	0	0	0	0	0	0	0	0	0	0
	Blue(1023)	0	0	0	0	0	0	0	0	0	0	0	0	0	0	0	0	0	0	0	0	1	1	1	1	1	1	1	1	1	1
	Cyan	0	0	0	0	0	0	0	0	0	0	1	1	1	1	1	1	1	1	1	1	1	1	1	1	1	1	1	1	1	1
	Magenta	1	1	1	1	1	1	1	1	1	1	0	0	0	0	0	0	0	0	0	0	1	1	1	1	1	1	1	1	1	1
	Yellow	1	1	1	1	1	1	1	1	1	1	1	1	1	1	1	1	1	1	1	1	0	0	0	0	0	0	0	0	0	0
	White	1	1	1	1	1	1	1	1	1	1	1	1	1	1	1	1	1	1	1	1	1	1	1	1	1	1	1	1	1	1
R	RED(000)	0	0	0	0	0	0	0	0	0	0	0	0	0	0	0	0	0	0	0	0	0	0	0	0	0	0	0	0	0	
	RED(001)	0	0	0	0	0	0	0	0	0	0	0	0	0	0	0	0	0	0	0	0	0	0	0	0	0	0	0	0	0	

	RED(1022)	1	1	1	1	1	1	1	1	1	0	0	0	0	0	0	0	0	0	0	0	0	0	0	0	0	0	0	0	0	
	RED(1023)	1	1	1	1	1	1	1	1	1	0	0	0	0	0	0	0	0	0	0	0	0	0	0	0	0	0	0	0	0	
G	GREEN(000)	0	0	0	0	0	0	0	0	0	0	0	0	0	0	0	0	0	0	0	0	0	0	0	0	0	0	0	0	0	
	GREEN(001)	0	0	0	0	0	0	0	0	0	0	0	0	0	0	0	0	0	0	1	0	0	0	0	0	0	0	0	0	0	

	GREEN(1022)	0	0	0	0	0	0	0	0	0	1	1	1	1	1	1	1	1	1	0	0	0	0	0	0	0	0	0	0	0	
	GREEN(1023)	0	0	0	0	0	0	0	0	0	1	1	1	1	1	1	1	1	1	1	0	0	0	0	0	0	0	0	0	0	
B	BLUE(000)	0	0	0	0	0	0	0	0	0	0	0	0	0	0	0	0	0	0	0	0	0	0	0	0	0	0	0	0	0	
	BLUE(001)	0	0	0	0	0	0	0	0	0	0	0	0	0	0	0	0	0	0	0	0	0	0	0	0	0	0	0	0	1	

	BLUE(1022)	0	0	0	0	0	0	0	0	0	0	0	0	0	0	0	0	0	0	0	1	1	1	1	1	1	1	1	1	0	
	BLUE(1023)	0	0	0	0	0	0	0	0	0	0	0	0	0	0	0	0	0	0	0	1	1	1	1	1	1	1	1	1	1	

5. Signal Timing Specification

This is the signal timing required at the input of the user connector. All of the interface signal timing should be satisfied with the following specifications for its proper operation.

5.1 Input Timing

5.1.1 Timing table

Timing Table (DE only Mode)

Signal	Item	Symbol	Min.	Typ.	Max	Unit
Vertical Section	Period	Tv	2230	2250	2715	Th
	Active	Tdisp (v)	2160			2160
	Blanking	Tblk (v)	70	90	555	Th
Horizontal Section	Period	Th	538	550	600	Tclk
	Active	Tdisp (h)	480			
	Blanking	Tblk (h)	58	70	120	Tclk
Clock	Frequency	Fclk=1/Tclk	66	74.25	77	MHz
Vertical Frequency	Frequency	Fv	47	60	63	Hz
Horizontal Frequency	Frequency	Fh	120	135	139.2	KHz

Notes:

(1) Display position is specific by the rise of DE signal only.

Horizontal display position is specified by the rising edge of 1st DCLK after the rise of 1st DE, is displayed on the left edge of the screen.

(2) Vertical display position is specified by the rise of DE after a “Low” level period equivalent to eight times of horizontal period. The 1st data corresponding to one horizontal line after the rise of 1st DE is displayed at the top line of screen.

(3) If a period of DE “High” is less than 1920 DCLK or less than 1080 lines, the rest of the screen displays black.

(4) The display position does not fit to the screen if a period of DE “High” and the effective data period do not synchronize with each other.

5.1.2 Signal Timing Waveform

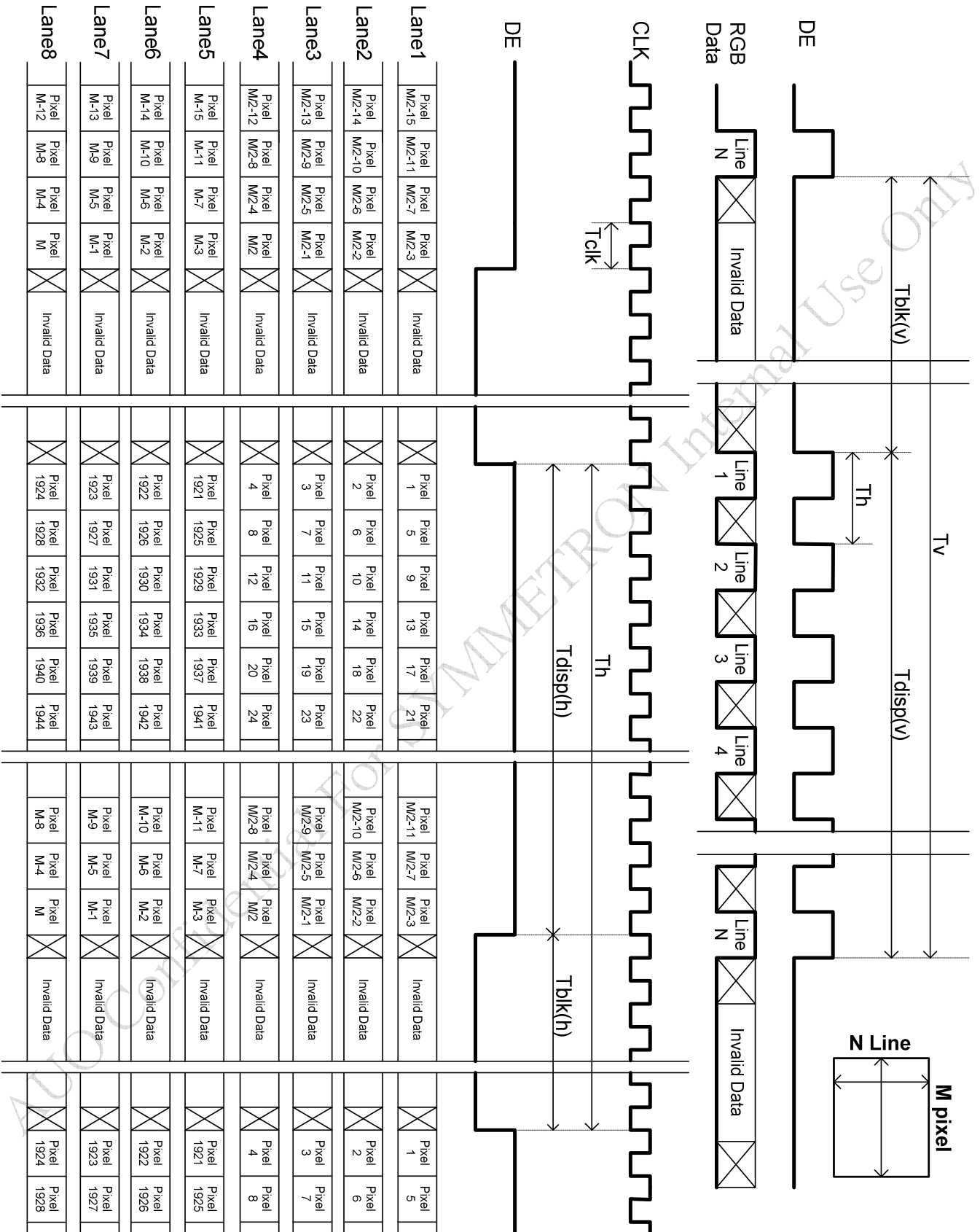

5.2 Input interface characteristics

5.2.1 V by one

Item		Symbol	Min.	Typ.	Max	Unit	Note
V-by-one Interface	VRXINP/N input each bit Period	T_{RRIP} (UI)	310	--	379	ps	10bit 1
	Receiver Clock : Spread Spectrum Modulation range	Fclk_ss	Fclk -0.5%	--	Fclk +0.5%	MHz	2
	Receiver Clock : Spread Spectrum Modulation frequency	Fss	30			KHz	2
	CDR training pattern time	T_{LOCK}	--	500	--	us	1
	Latency from LOCKN 'HIGH' to clock training pattern	L1	0	--	--	us	1
	Latency from LOCKN 'LOW' to normal 8b10b data	L2	--	--	70	us	1
	CML Differential Input High Threshold	V_{RTH}	+50	--	--	mV _{DC}	
	CML Differential Input Low Threshold	V_{RTL}	--	--	-50	mV _{DC}	
	CML Common mode Bias Voltage	V_{RCT}	0.8	0.9	1.0	mV _{DC}	
	Intra-pair skew	T_{INTRA}	--	--	0.3	UI	3
	Inter-pair skew	T_{INTER}	--	--	5	UI	4
	Eye diagram at receiver	A_X	--	0.25	--	UI	5
		A_Y	--	0	--	mV	
		B_X	--	0.3	--	UI	
B_Y		--	50	--	mV		
C_X		--	0.7	--	UI		
C_Y		--	50	--	mV		
D_X		--	0.75	--	UI		
D_Y		--	0	--	mV		
E_X		--	0.7	--	UI		
E_Y		--	-50	--	mV		
F_X	--	0.3	--	UI			
F_Y	--	-50	--	mV			

Note :

1. V-by-one Signal diagram

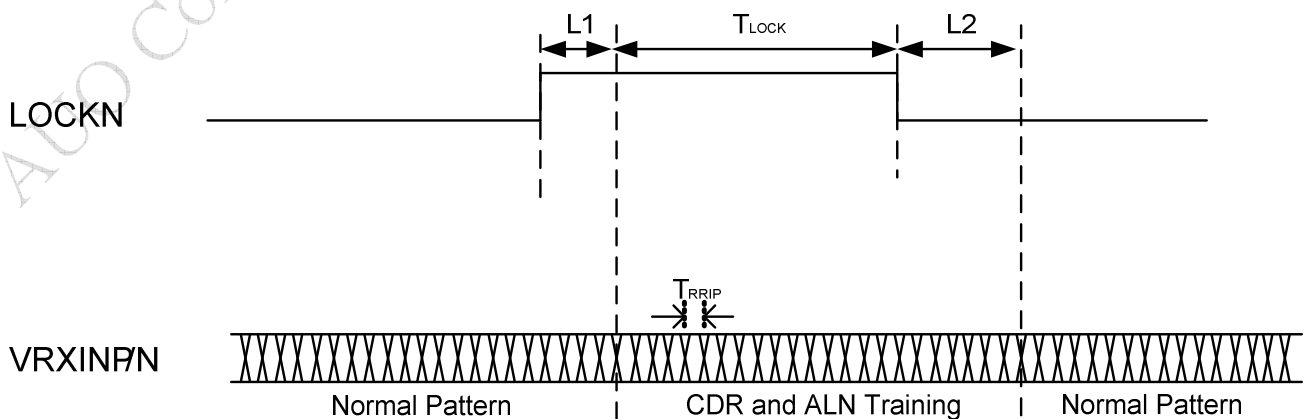

2. Receiver Clock SSCG (Spread spectrum clock generator) is defined as below figures.

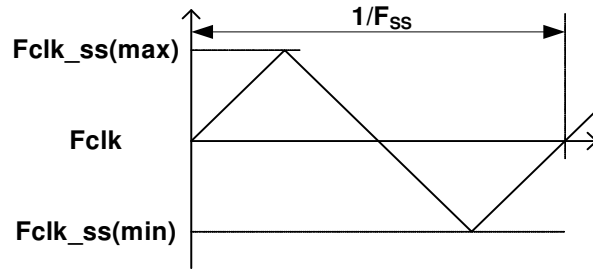

3. V-by-one Intra-pair Skew

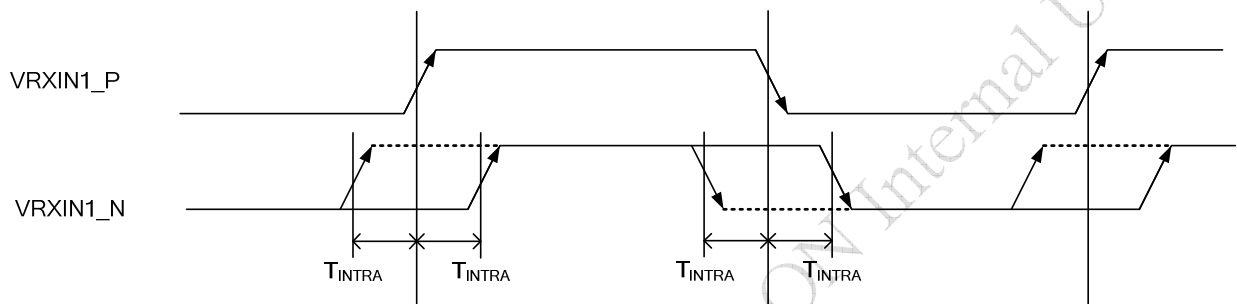

4. V-by-one Inter-pair Skew

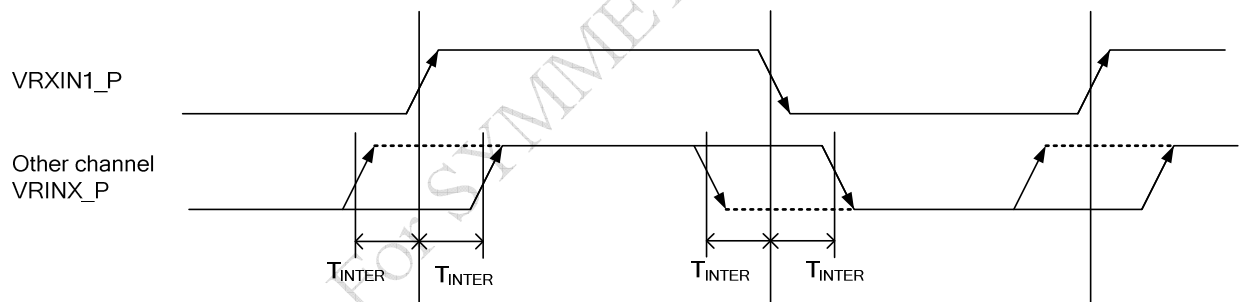

5. Eye diagram at receiver

Eye Mask

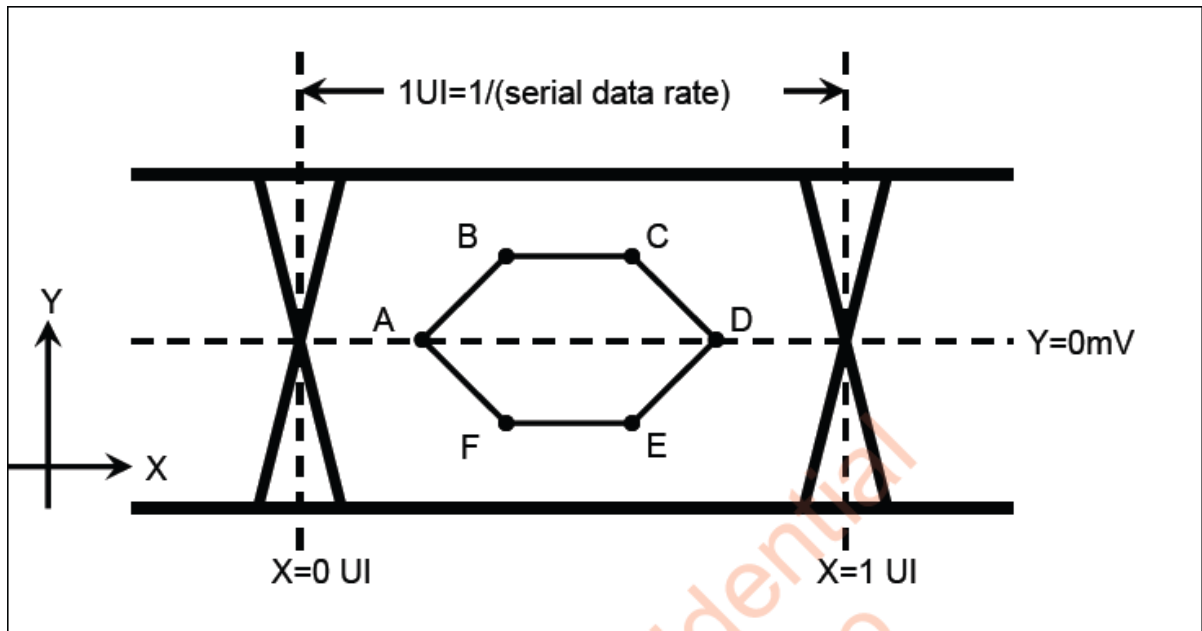

Example of Eye diagram



5.3 Power Sequence for LCD

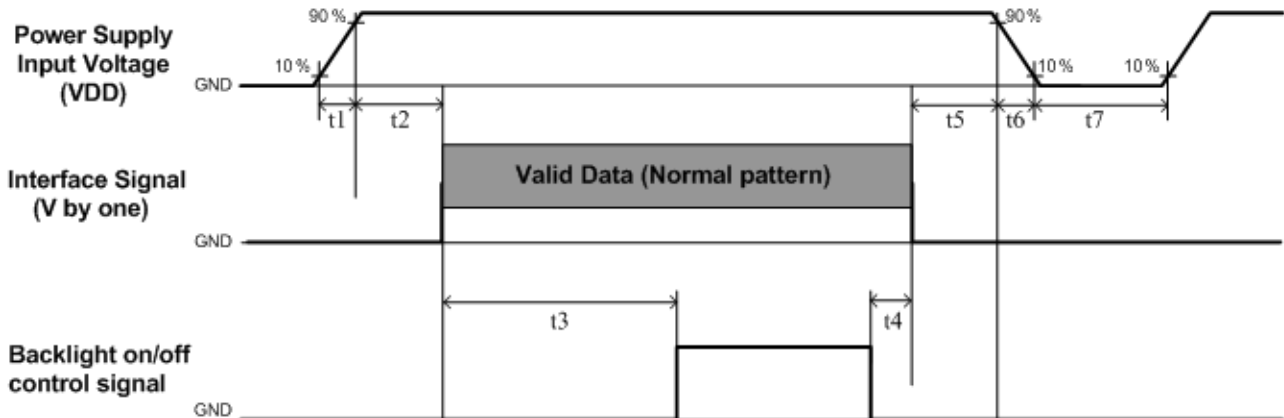

Parameter	Values			Unit
	Min.	Type.	Max.	
t1	0.4	---	30	ms
t2	40	---	---	ms
t3	2400	---	---	ms
t4	0 ^{*1}	---	---	ms
t5	0	---	---	ms
t6	---	---	--- ^{*2}	ms
t7	1000	---	---	ms

Note :

- (1) t4=0 : concern for residual pattern before BLU turn off.
- (2) t6 : voltage of VDD must decay smoothly after power-off. (customer system decide this value)
- (3) When the power supply input voltage(VDD) is off, be sure to pull down the valid and the invalid data to 0V.

6. Backlight Specification

6.1 Electrical specification

	Item	Symbol	Condition	Min	Typ	Max	Unit	Note	
1	Power Supply Input Voltage	V _{DDB}	-	22.8	24	25.2	V	-	
2	Power Supply Input Current	I _{DDB}	V _{DDB} =24V		11.6	12.6	A	1	
3	Power Consumption	P _{DDB}	V _{DDB} =24V		277	301.8	Watt	1	
4	Inrush Current	I _{RUSH}	V _{DDB} =24V			21	A	2	
5	Control signal voltage	V _{Signal}	V _{DDB} =24V	Hi	2	-	3.3	V	-
				Low	-0.3	-	0.8		3
6	Control signal current	I _{Signal}	V _{DDB} =24V	-	-	1.5	mA	-	
7	External PWM Duty ratio (input duty ratio)	D_EPWM	V _{DDB} =24V	5 (TBD)	-	100 (TBD)	%	4	
8	External PWM Frequency	F_EPWM	V _{DDB} =24V	140 (TBD)	180 (TBD)	240 (TBD)	Hz	4	
9	DET status signal	DET	V _{DDB} =24V	Hi	Open Collector			V	5
				Lo	0	-	0.8	V	5
10	Input Impedance	R _{in}	V _{DDB} =24V	300			Kohm	-	
11	LED lifetime	LTLED	-	50,000	60,000		Hr	6	

Note 1: Dimming ratio= 100%, (Ta=25±5°C, Turn on for 45minutes)

Note 2: MAX input current while DB turn on, measurement condition V_{DDB} rising time=20ms(V_{DDB}: 10%~90%)

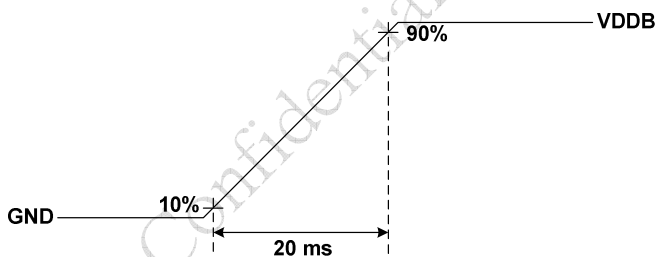

Note 3: When BLU off (V_{DDB} = 24V , V_{BLON} = 0V) , I_{DDB} (max) = 0.1A

Note 4: Less than 5% dimming control is functional well and no backlight shutdown happened

Note 5: Normal: 0~0.8V ; Abnormal : Open collector

Note 6: The lifetime (MTTF) is defined as the time which luminance of LED is 50% compared to its original value.

[Operating condition: Continuous operating at Ta = 25±2°C, for single LED only]

6.2 Input Pin Assignment

LED DB connector: CI0114M1HRL-NH(CviLux) or equivalent
 CI0112M1HRL-NH(CviLux) or equivalent

Pin	Symbol	Description	Note
1	VDDB	Power Supply Input Voltage	
2	VDDB	Power Supply Input Voltage	
3	VDDB	Power Supply Input Voltage	
4	VDDB	Power Supply Input Voltage	
5	VDDB	Power Supply Input Voltage	
6	GND	Ground	
7	GND	Ground	
8	GND	Ground	
9	GND	Ground	
10	GND	Ground	
11	DET	BLU status detection:	1
12	VBLON	BLU On-Off control:	2,3
13	NC	NC	4
14	PDIM	External PWM	2, 5

Pin	Symbol	Description	Note
1	VDDDB	Power Supply Input Voltage	
2	VDDDB	Power Supply Input Voltage	
3	VDDDB	Power Supply Input Voltage	
4	VDDDB	Power Supply Input Voltage	
5	VDDDB	Power Supply Input Voltage	
6	GND	Ground	
7	GND	Ground	
8	GND	Ground	
9	GND	Ground	
10	GND	Ground	
11	NC	NC	4
12	NC	NC	4

Note1. DET status

DET	BLU status
0 ~ 0.8V	Normal
Open collector	Abnormal

Recommend pull high R > 10K ohm, pull high voltage VDD = 3.3V

Note2. input control signal threshold voltage definition

Item	Symbol	Min.	Typ.	Max.	Unit
Input High Threshold Voltage	VIH	2	-	5.5	V
Input Low Threshold Voltage	VIL	0	-	0.8	V

Note3. VBLON

Mode selection

VBLON	Note
H or OPEN	BL On
L	BL Off

Note4. Please leave this pin unoccupied. It cannot be connected by any signal (Low/GND/High).

Note5. PDIM

PWM Dimming range:

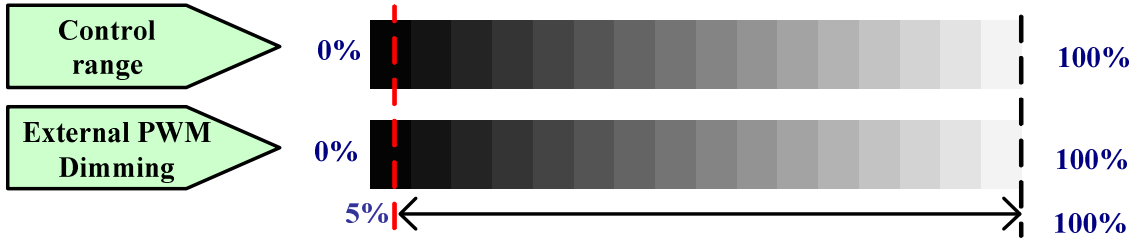

Performance guaranteed dimming range: 0%, 5~100%

IF External PWM function less than 5% dimming ratio, Judge condition as below:

- (1) Backlight module must be lighted ON normally.
- (2) All protection function must work normally.
- (3) Uniformity and flicker could not be guaranteed

6.3 Power Sequence for Backlight

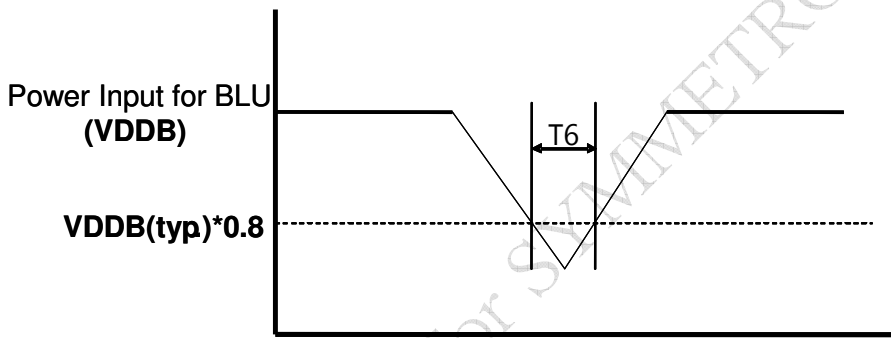
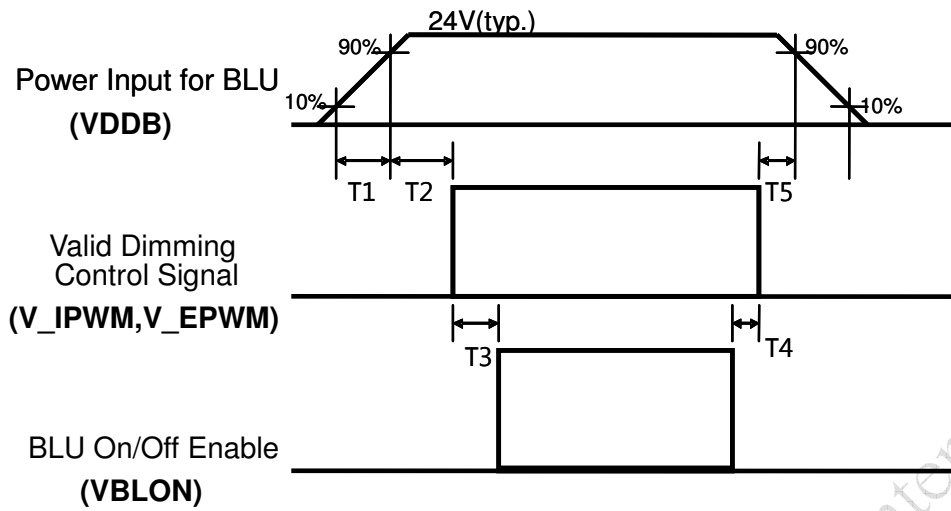

Dip condition

Parameter	Min	Typ	Max	Units
T1	20	-	-	ms ^{*1}
T2	250	-	-	ms
T3	2200	-	-	ms
T4	0	-	-	ms
T5	0	-	-	ms
T6		-	1000	ms ^{*2}

Note:1. T6 describes VDDDB dip condition and VDDDB couldn't lower than 10% VDDDB.

7. Mechanical Characteristics

The contents provide general mechanical characteristics for the model P550HVN06.4. In addition the figures in the next page are detailed mechanical drawing of the LCD.

Item		Dimension	Unit	Note
Outline Dimension	Horizontal	1910.0	mm	
	Vertical	1091.0	mm	
	Depth (Dmin)	61.4	mm	front bezel to DB Cover
	Depth (Dmax)	69.7	mm	to wall mount
Weight	34		Kg	

Front View

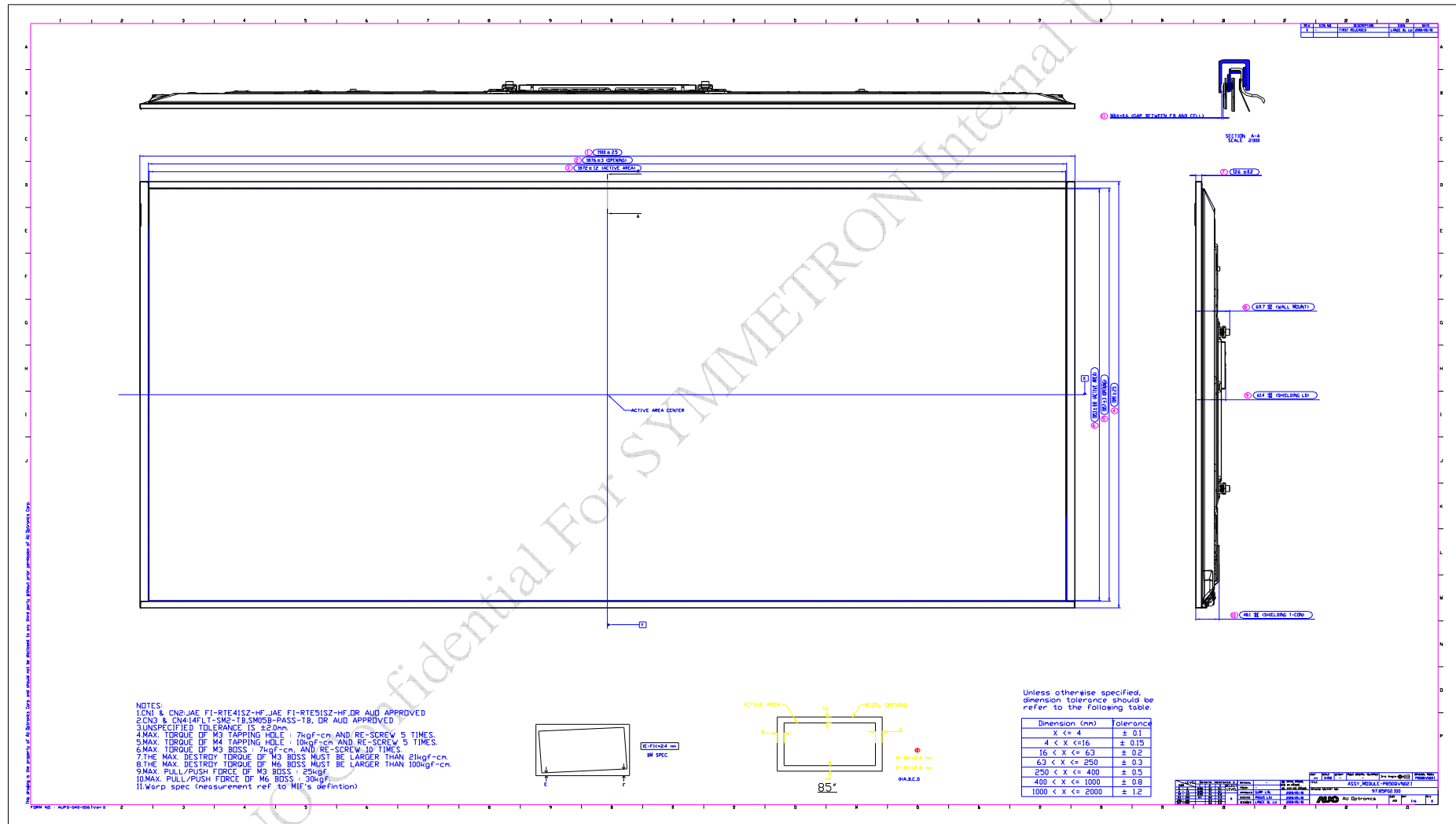

Back View

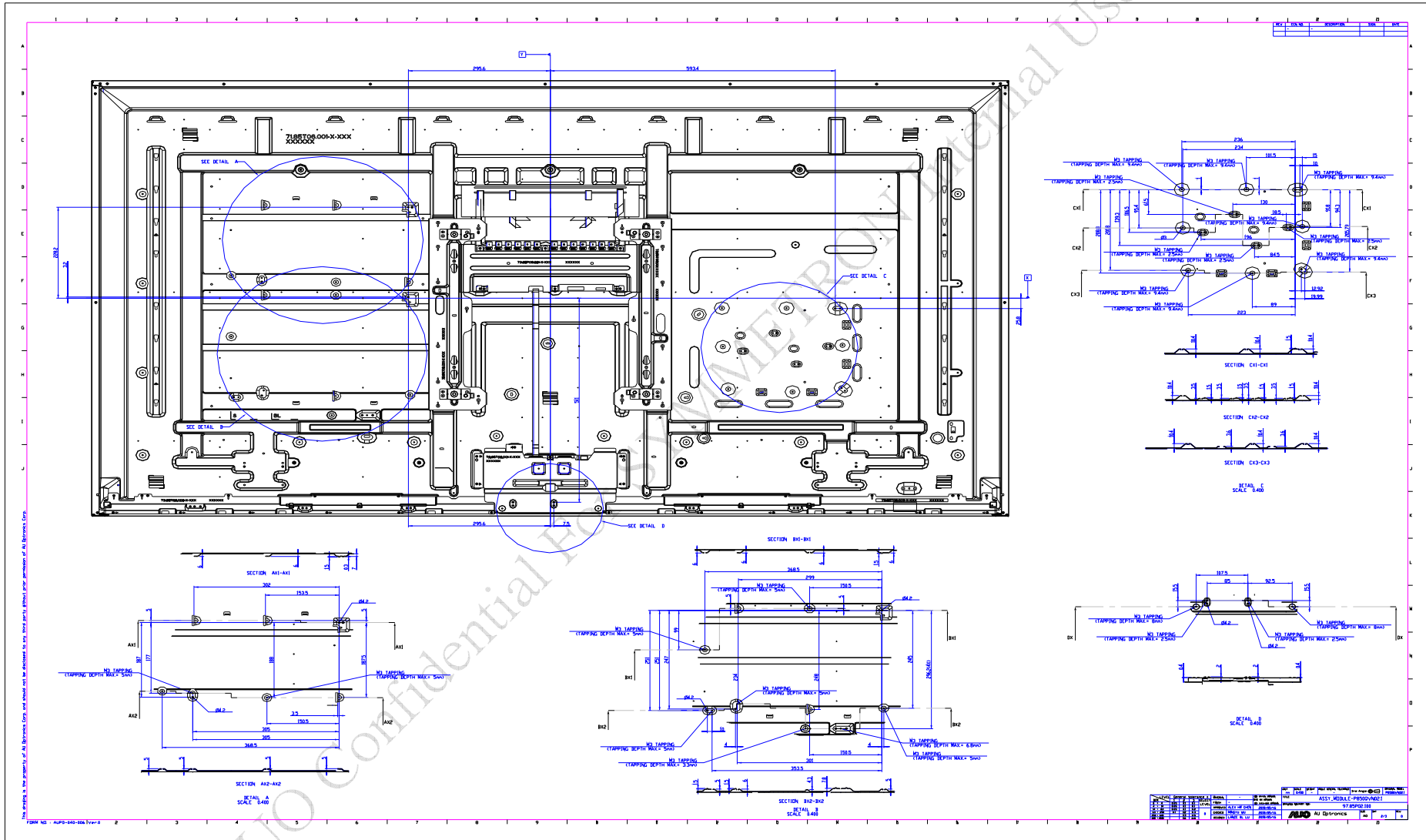

8. Reliability Test Items

	Test Item	Q'ty	Condition
1	High temperature storage test	3	60°C, 500hrs
2	Low temperature storage test	3	-20°C, 500hrs
3	High temperature operation test	3	50°C, 500hrs
4	Low temperature operation test	3	-5°C, 500hrs
5	Vibration test (With carton)	1(PKG)	Random wave (1.04Grms 2~200Hz) Duration : X,Y,Z 20min per axes
6	Drop test (With carton)	1(PKG)	Height: 25.4 cm Direction: Only bottom flat twice (ASTMD4169-I)

9. International Standard

9.1 Safety

- (1) UL 60950-1; Standard for Safety of Information Technology Equipment Including electrical Business Equipment.
- (2) IEC 60950-1; Standard for Safety of International Electrotechnical Commission
- (3) EN 60950-1; European Committee for Electrotechnical Standardization (CENELEC), EUROPEAN STANDARD for Safety of Information Technology Equipment Including Electrical Business Equipment.

9.2 EMC

- (1) ANSI C63.4 "Methods of Measurement of Radio-Noise Emissions from Low-Voltage Electrical and Electrical Equipment in the Range of 9kHz to 40GHz." American National standards Institute(ANSI), 1992
- (2) C.I.S.P.R "Limits and Methods of Measurement of Radio Interface Characteristics of Information Technology Equipment." International Special committee on Radio Interference.
- (3) EN 55022 "Limits and Methods of Measurement of Radio Interface Characteristics of Information Technology Equipment." European Committee for Electrotechnical Standardization. (CENELEC), 1998

10. Packing

10.1 Definition of Label

A. Panel Label:

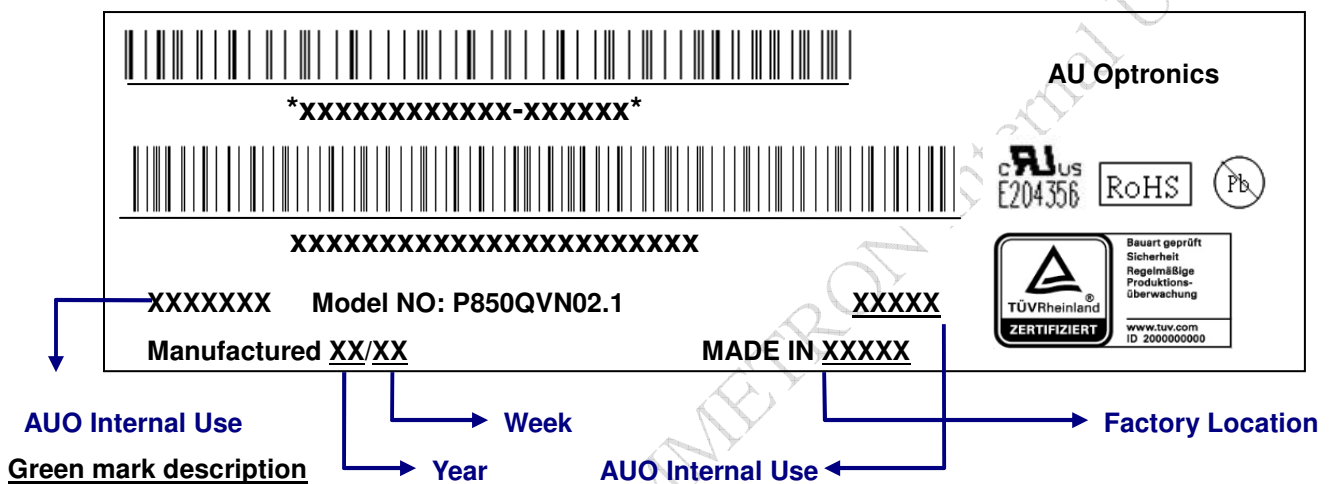
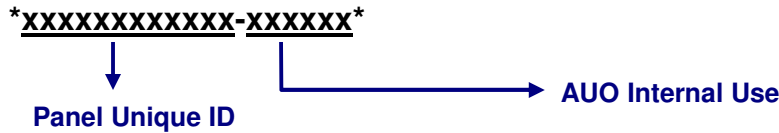

(1) For Pb Free Product, AUO will add for identification.

(2) For RoHS compatible products, AUO will add for identification.

Note: The green Mark will be present only when the green documents have been ready by AUO internal green team. (definition of green design follows the AUO green design checklist.)

B. Carton Label:

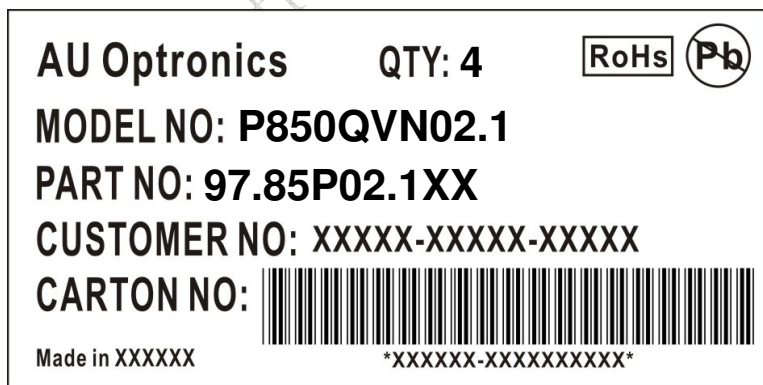

10.2 Packing Methods

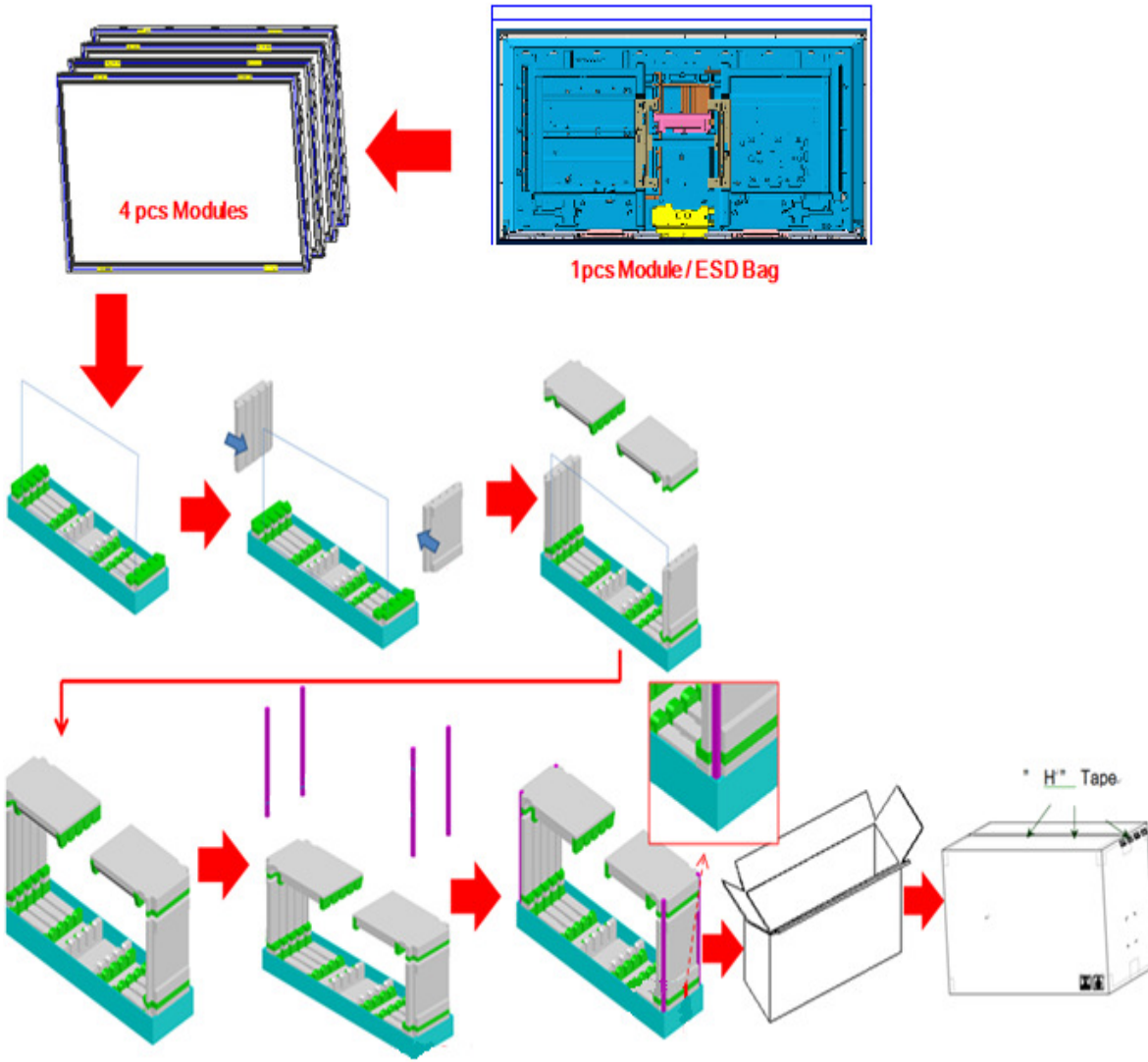

AUO Confidential

10.3 Pallet and Shipment Information

	Item	Specification			Packing Remark
		Qty.	Dimension	Weight (kg)	
1	Packing Box	4pcs/box	2073(L)mm*560 (W)mm*1257(H)mm	158.04	Panel 34.0kg
2	Pallet	1	2150(L)mm*1180(W)mm*150(H)mm	46	
3	Boxes per Pallet	2 boxes/Pallet (By Air) ; 2 Boxes/Pallet (By Sea)			
4	Panels per Pallet	8 pcs/pallet(By Air) ; 8 pcs/Pallet (By Sea)			
5	Pallet after packing	8(by Air)	2150(L)mm*1180(W)mm*1407 (H)mm	362.08(by Air)	
		8 (by Sea)	2150(L)mm*1180(W)mm*1407(H)mm	362.08(by Sea)	

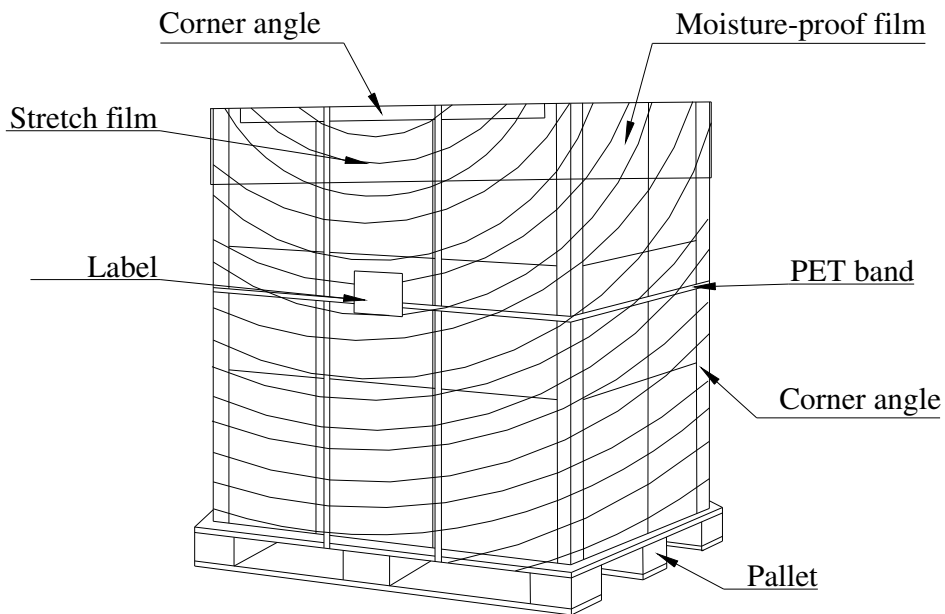

11. Precautions

Please pay attention to the followings when you use this TFT LCD module.

11.1. Mounting Precautions

- (1) You must mount a module using holes arranged in four corners or four sides.
- (2) You should consider the mounting structure so that uneven force (ex. twisted stress) is not applied to module. And the case on which a module is mounted should have sufficient strength so that external force is not transmitted directly to the module.
- (3) Please attach the surface transparent protective plate to the surface in order to protect the polarizer. Transparent protective plate should have sufficient strength in order to resist external force.
- (4) You should adopt radiation structure to satisfy the temperature specification.
- (5) Acetic acid type and chlorine type materials for the cover case are not desirable because the former generates corrosive gas of attacking the polarizer at high temperature and the latter cause circuit broken by electro-chemical reaction.
- (6) Do not touch, push or rub the exposed polarizer with glass, tweezers or anything harder than HB pencil lead. And please do not rub with dust clothes with chemical treatment. Do not touch the surface of polarizer for bare hand or greasy cloth. (Some cosmetics are detrimental to the polarizer.)
- (7) When the surface becomes dusty, please wipe gently with absorbent cotton or other soft materials like chamois soaks with petroleum benzene. Normal-hexane is recommended for cleaning the adhesives used to attach front/ rear polarizer. Do not use acetone, toluene and alcohol because they cause chemical damage to the polarizer.
- (8) Wipe off saliva or water drops as soon as possible. Their long time contact with polarizer causes deformations and color fading.
- (9) Do not open the case because inside circuits do not have sufficient strength.

11.2. Operating Precautions

- (1) The spike noise causes the mis-operation of circuits. It should be lower than following voltage: $V = \pm 200\text{mV}$ (Over and under shoot voltage)
- (2) Response time depends on the temperature. (In lower temperature, it becomes longer.)
- (3) Brightness depends on the temperature. (In lower temperature, it may become lower.) And in lower temperature, response time (required time that brightness is stable after turned on) becomes longer.
- (4) Be careful for condensation at sudden temperature change. Condensation makes damage to polarizer or electrical contacted parts. And after fading condensation, smear or spot will occur.
- (5) When fixed patterns are displayed for a long time, remnant image is likely to occur.
- (6) Module has high frequency circuits. Sufficient suppression to the electromagnetic

interference shall be done by system manufacturers. Grounding and shielding methods may be important to minimize the interface.

- (7) The conductive material and signal cables are kept away from LED driver inductor to prevent abnormal display, sound noise and temperature rising.

11.3. Operating Condition for Public Information Display

The device listed in the product specification is designed and manufactured for PID (Public Information Display) application. To optimize module's lifetime and function, below operating usages are required.

(1) Normal operating condition

- A. Operating temperature: 0~50°C
- B. Operating humidity: 10~90%
- C. Display pattern: dynamic pattern (Real display).

Note) Long-term static display would cause image sticking.

(2) Operation usage to protect against image sticking due to long-term static display.

- A. Suitable operating time: under 24 hours a day
(* The moving picture can be allowed for 24 hours a day)
- B. Liquid Crystal refresh time is required. Cycling display between 5 minutes' information (static) display and 10 seconds' moving image.
- C. Periodically change background and character (image) color.
- D. Avoid combination of background and character with large different luminance.

(3) Periodically adopt one of the following actions after long time display.

- A. Running the screen saver (motion picture or black pattern)
- B. Power off the system for a while

(4) LCD system is required to place in well-ventilated environment. Adapting active cooling system is highly recommended.

(5) Product reliability and functions are only guaranteed when the product is used under right operation usages. If product will be used in extreme conditions, such as high temperature/humidity, display stationary patterns, or long operation time etc..., it is strongly recommended to contact AUO for filed application engineering advice. Otherwise, its reliability and function may not be guaranteed. Extreme conditions are commonly found at airports, transit stations, banks, stock market and controlling systems.

11.4. Electrostatic Discharge Control

Since a module is composed of electronic circuits, it is not strong to electrostatic discharge. Make certain that treatment persons are connected to ground through wristband etc. And don't touch interface pin directly.

11.5. Precautions for Strong Light Exposure

- (1) Strong light exposure causes degradation of polarizer and color filter.
- (2) To keep display function well as a digital signage application, especially the component of TFT is very sensitive to sunlight, it is necessary to set up blocking device protecting panel from radiation of ambient environment.

11.6. Storage

When storing modules as spares for a long time, the following precautions are necessary.

- (1) Store them in a dark place. Do not expose the module to sunlight or fluorescent light. Keep the temperature between 5°C and 35°C at normal humidity.
- (2) The polarizer surface should not come in contact with any other object. It is recommended that they be stored in the container in which they were shipped.
- (3) Storage condition is guaranteed under packing conditions.
- (4) The phase transition of Liquid Crystal in the condition of the low or high storage temperature will be recovered when the LCD module returns to the normal condition.

11.7. Handling Precautions for Protection Film



- (1) The protection film is attached to the bezel with a small masking tape. When the protection film is peeled off, static electricity is generated between the film and polarizer. This should be peeled off slowly and carefully by people who are electrically grounded and with well ion-blown equipment or in such a condition, etc.
- (2) When the module with protection film attached is stored for a long time, sometimes there remains a very small amount of glue still on the bezel after the protection film is peeled off.
- (3) You can remove the glue easily. When the glue remains on the bezel or its vestige is recognized, please wipe them off with absorbent cotton waste or other soft material like chamois soaked with normal-hexane.

11.8. Dust Resistance

- (1) AUO module dust test is conducted with marked holes (see Figure 1) sealed to comply with JIS D0207 .
- (2) Module users should design set with these holes used/sealed(if not used) or covered by set mechanism to prevent dust from entering. The AUO testing procedure cannot replicate all different real world scenarios, module users should apply set dust resistance solution to meet users' requirement.

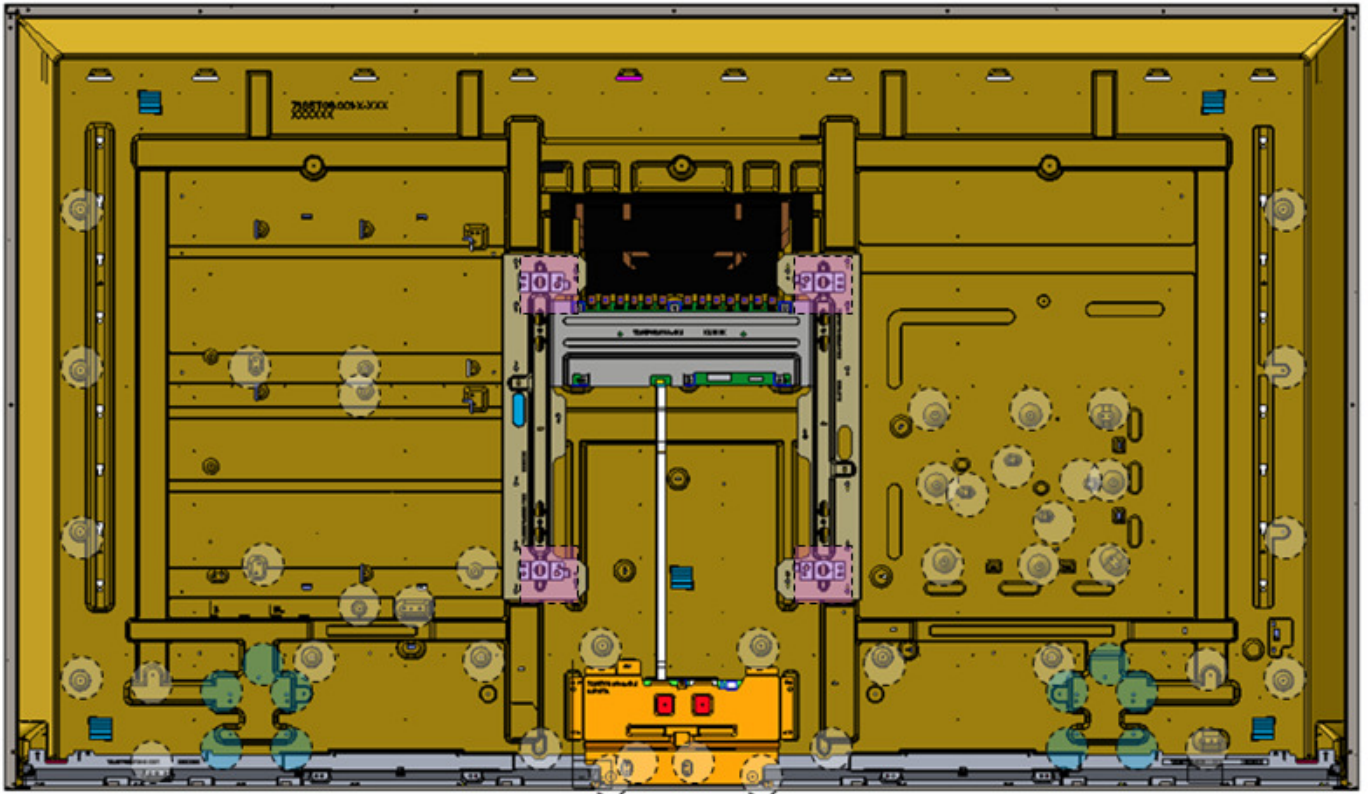
Figure 1



-  M3 BARRING TAP 43 PCS
-  M4 BARRING TAP 10 PCS
-  M6 BARRING TAP 4PCS

AUO Confidential For