

SEANNA-A

~2.3° spot beam. Assembly with holder.

TECHNICAL SPECIFICATIONS:

Dimensions	Ø 155.2 mm
Height	82 mm
Fastening	pin, screw
ROHS compliant	yes ⓘ

MATERIAL SPECIFICATIONS:

Component	Type	Material	Colour	Finish
SEANNA-A	Single lens	PMMA	clear	
SEANNA-FRES	Single lens	PMMA	clear	
SEANNA-HLD-B	Holder	PA66GF30	black	
SEANNA-HLD-B-TOPRING	Holder	PA66GF30	black	
SEANNA-HLD-B-BOTTOMRING	Holder	PA66GF30	black	
SEANNA-SCREW	Accessory	Stainless steel	clear	



ORDERING INFORMATION:

Component	Qty in box	MOQ	MPQ	Box weight (kg)
FCP13895_SEANNA-A » Box size:		20	2	6.5

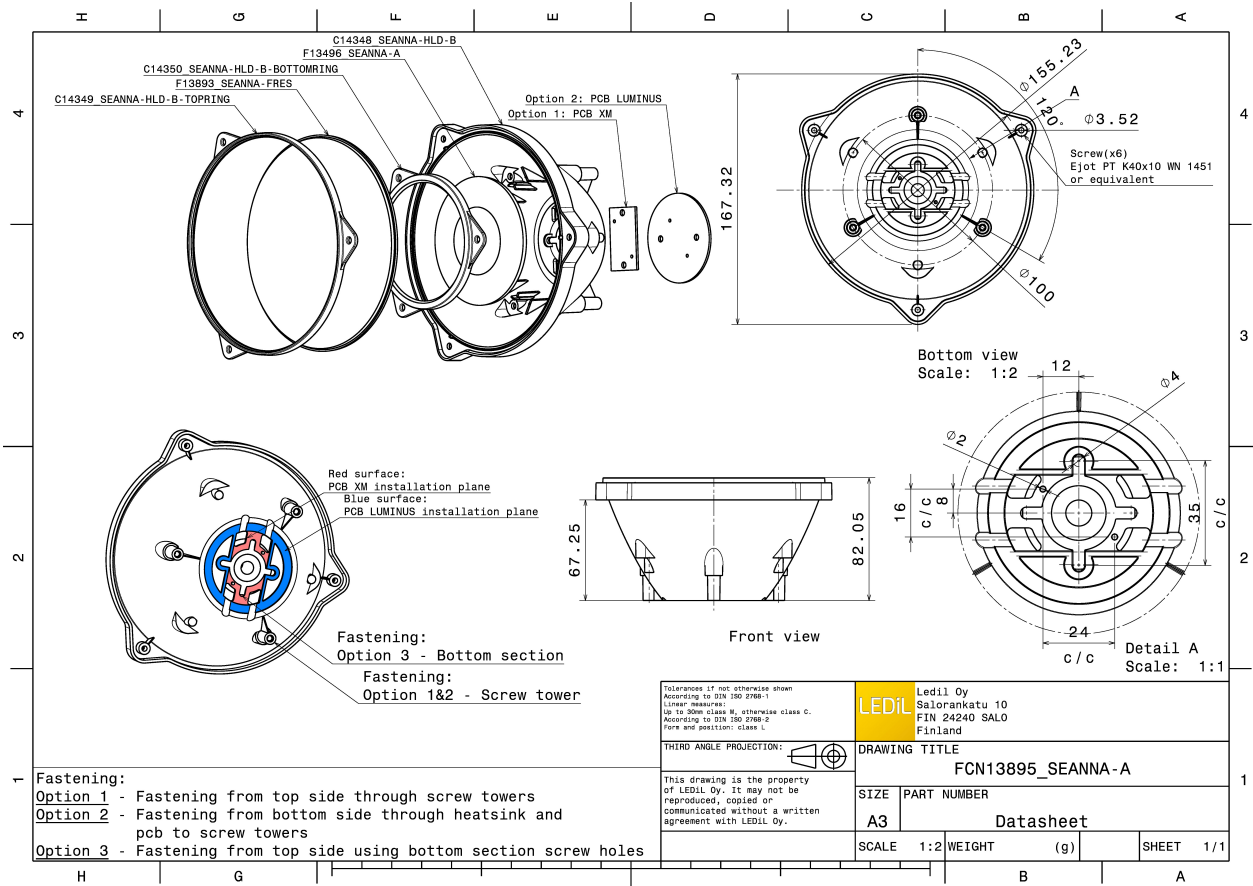

See also our general installation guide: www.ledil.com/installation_guide

PHOTOMETRIC DATA (MEASURED):

CREE LED

LED XD16
 FWHM / FWTM 1.0° / 3.0°
 Efficiency 91 %
 Peak intensity 629 cd/lm
 LEDs/each optic 1
 Light colour White
 Required components:

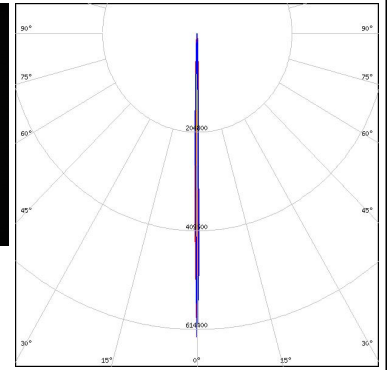
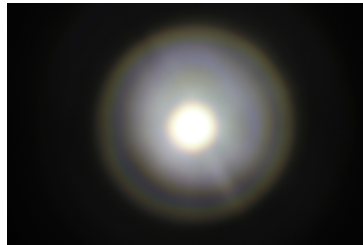

CREE LED

LED XP-E2
 FWHM / FWTM 1.0° / 3.0°
 Efficiency %
 Peak intensity 718 cd/lm
 LEDs/each optic 1
 Light colour White
 Required components:

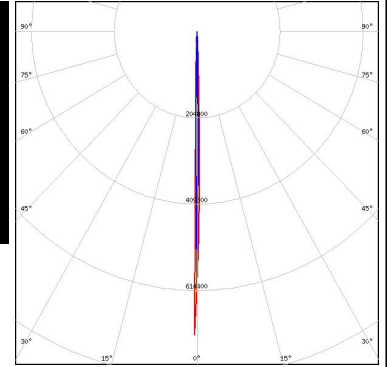

CREE LED

LED XP-L HD
 FWHM / FWTM 2.4° / 5.3°
 Efficiency 94 %
 Peak intensity 255 cd/lm
 LEDs/each optic 1
 Light colour White
 Required components:

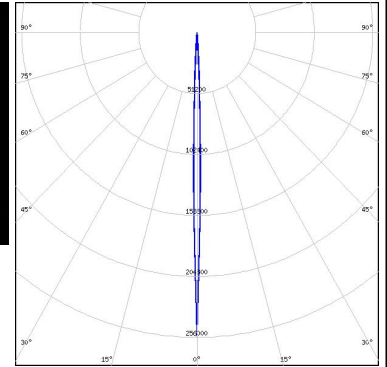

CREE LED

LED XP-L HI
 FWHM / FWTM 1.6° / 3.2°
 Efficiency 94 %
 Peak intensity 492 cd/lm
 LEDs/each optic 1
 Light colour White
 Required components:

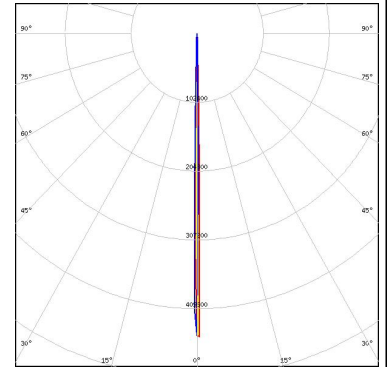

PHOTOMETRIC DATA (MEASURED):

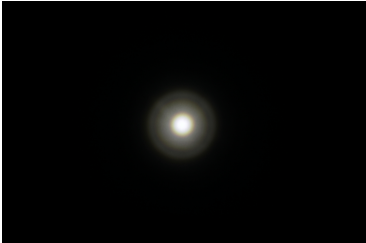
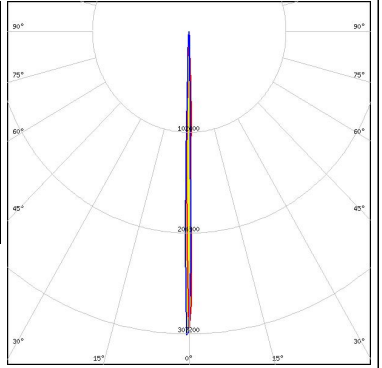
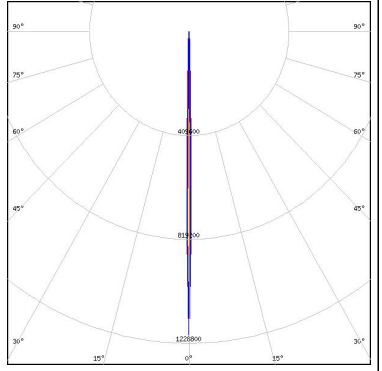
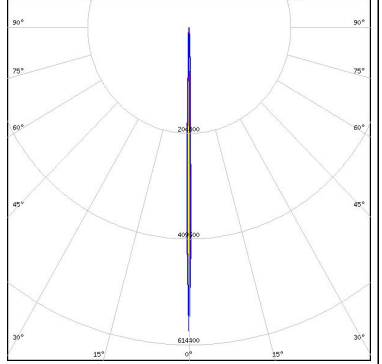
<p>NICHIA</p> <p>LED NVSW3x9A FWHM / FWTM 1.9° / 4.1° Efficiency 92 % Peak intensity 310 cd/lm LEDs/each optic 1 Light colour White Required components:</p>		
<p>OSRAM <small>Opto Semiconductors</small></p> <p>LED OSLOM Black Flat FWHM / FWTM 1.2° / 2.3° Efficiency 94 % Peak intensity 1196 cd/lm LEDs/each optic 1 Light colour White Required components:</p>		
<p>OSRAM <small>Opto Semiconductors</small></p> <p>LED OSLOM Square CSSRM2/CSSRM3 FWHM / FWTM 1.5° / 3.3° Efficiency 94 % Peak intensity 587 cd/lm LEDs/each optic 1 Light colour White Required components:</p>		







PHOTOMETRIC DATA (SIMULATED):

<p>CREE → LED</p> <p>LED MK-R FWHM / FWTM 4.0° / 10.4° Efficiency 91 % Peak intensity 82 cd/lm LEDs/each optic 1 Light colour White Required components:</p>	
<p>CREE → LED</p> <p>LED XB-D FWHM / FWTM 1.3° / 3.2° Efficiency 87 % Peak intensity 698 cd/lm LEDs/each optic 1 Light colour White Required components:</p>	
<p>CREE → LED</p> <p>LED XHP35 HD FWHM / FWTM 2.4° / 4.2° Efficiency 89 % Peak intensity 257 cd/lm LEDs/each optic 1 Light colour White Required components:</p>	
<p>CREE → LED</p> <p>LED XHP35 HI FWHM / FWTM 1.6° / 3.6° Efficiency 83 % Peak intensity 496 cd/lm LEDs/each optic 1 Light colour White Required components:</p>	

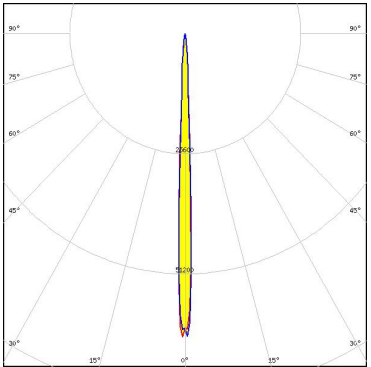

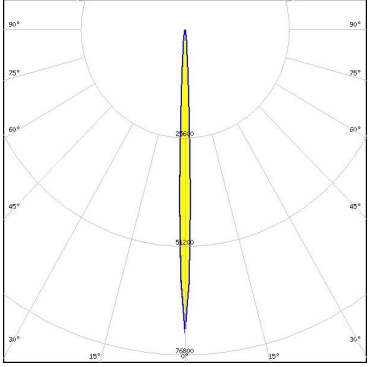

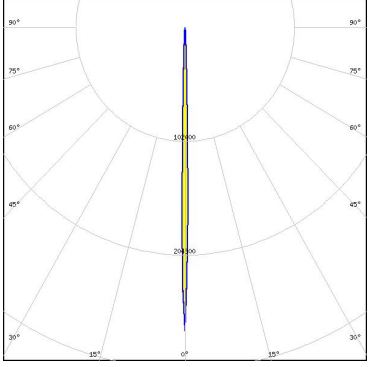

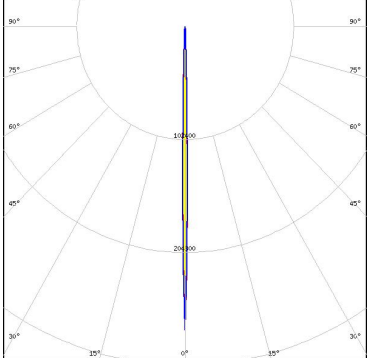
PHOTOMETRIC DATA (SIMULATED):

<p>CREE LED</p> <p>LED: XHP35.2 HD FWHM / FWTM: 2.0° / 6.0° Efficiency: 89 % Peak intensity: 161.9 cd/lm LEDs/each optic: 1 Light colour: White Required components:</p>	
<p>CREE LED</p> <p>LED: XHP35.2 HI FWHM / FWTM: 2.0° / 4.0° Efficiency: 89 % Peak intensity: 161 cd/lm LEDs/each optic: 1 Light colour: White Required components:</p>	
<p>CREE LED</p> <p>LED: XHP50 FWHM / FWTM: 3.3° / 6.7° Efficiency: 87 % Peak intensity: 122 cd/lm LEDs/each optic: 1 Light colour: White Required components:</p>	
<p>CREE LED</p> <p>LED: XHP50.2 FWHM / FWTM: 2.7° / 6.8° Efficiency: 84 % Peak intensity: 128.7 cd/lm LEDs/each optic: 1 Light colour: White Required components:</p>	

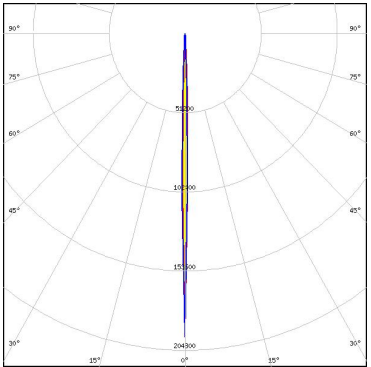
PHOTOMETRIC DATA (SIMULATED):

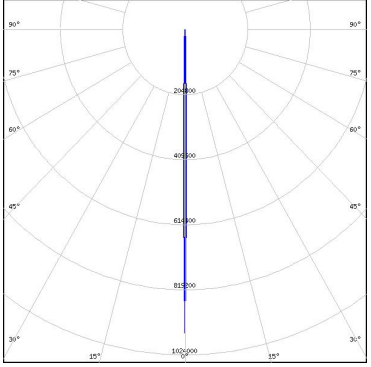
	<p>LED XHP70 FWHM / FWTM 4.3° / 10.4° Efficiency 81 % Peak intensity 69.9 cd/lm LEDs/each optic 1 Light colour White Required components:</p>	
	<p>LED XHP70.2 FWHM / FWTM 4.5° / 10.1° Efficiency 83 % Peak intensity 71.6 cd/lm LEDs/each optic 1 Light colour White Required components:</p>	
	<p>LED XM-L FWHM / FWTM 2.4° Efficiency % Peak intensity 272 cd/lm LEDs/each optic 1 Light colour White Required components:</p>	
	<p>LED XM-L2 FWHM / FWTM 2.0° / 3.9° Efficiency 85 % Peak intensity 275 cd/lm LEDs/each optic 1 Light colour White Required components:</p>	

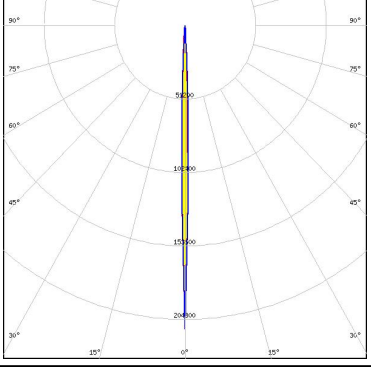
PHOTOMETRIC DATA (SIMULATED):

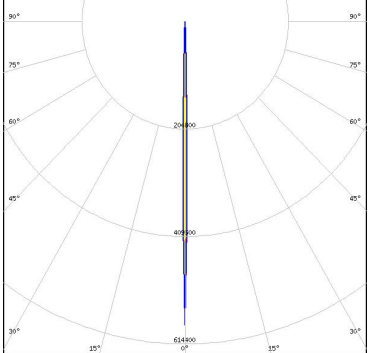
	<p>LED XM-L3 FWHM / FWTM 2.0° / 6.0° Efficiency 90 % Peak intensity 196.2 cd/lm LEDs/each optic 1 Light colour White Required components:</p>	
	<p>LED XP-E FWHM / FWTM 1.2° / 2.9° Efficiency 92 % Peak intensity 955 cd/lm LEDs/each optic 1 Light colour White Required components:</p>	
	<p>LED XP-E2 FWHM / FWTM 2.0° / 6.0° Efficiency 85 % Peak intensity 211.5 cd/lm LEDs/each optic 1 Light colour Blue Required components:</p>	
	<p>LED XP-G FWHM / FWTM 1.4° / 3.4° Efficiency 90 % Peak intensity 578 cd/lm LEDs/each optic 1 Light colour White Required components:</p>	

PHOTOMETRIC DATA (SIMULATED):

<p>CREE LED</p> <p>LED: XP-G2 FWHM / FWTM: 1.4° / 3.2° Efficiency: 91 % Peak intensity: 628 cd/lm LEDs/each optic: 1 Light colour: White Required components:</p>	
<p>CREE LED</p> <p>LED: XP-G2 HE FWHM / FWTM: 2.0° / 4.0° Efficiency: 89 % Peak intensity: 286.5 cd/lm LEDs/each optic: 1 Light colour: White Required components:</p>	
<p>CREE LED</p> <p>LED: XP-G3 FWHM / FWTM: 2.0° / 4.0° Efficiency: 88 % Peak intensity: 246.2 cd/lm LEDs/each optic: 1 Light colour: White Required components:</p>	
<p>CREE LED</p> <p>LED: XP-P FWHM / FWTM: 2.0° / 6.0° Efficiency: 84 % Peak intensity: 246.8 cd/lm LEDs/each optic: 1 Light colour: White Required components:</p>	

PHOTOMETRIC DATA (SIMULATED):



LED XQ-E HD
 FWHM / FWTM 1.1° / 2.5°
 Efficiency 92 %
 Peak intensity 1460 cd/lm
 LEDs/each optic 1
 Light colour White
 Required components:

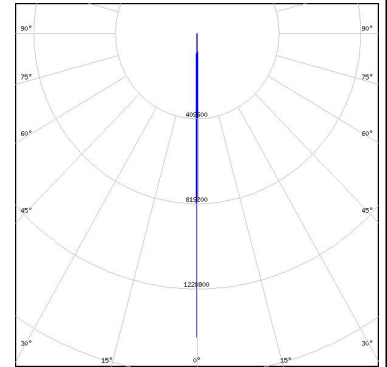

LED XQ-E HI
 FWHM / FWTM 1.2° / 2.0°
 Efficiency 90 %
 Peak intensity 1300 cd/lm
 LEDs/each optic 1
 Light colour White
 Required components:



LED XT-E
 FWHM / FWTM 1.4° / 3.5°
 Efficiency 88 %
 Peak intensity 519 cd/lm
 LEDs/each optic 1
 Light colour White
 Required components:

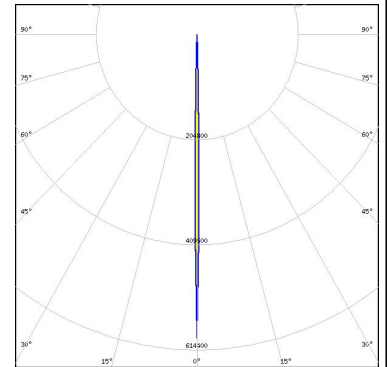

LED LZ4 (00xW00)
 FWHM / FWTM 3.3° / 8.2°
 Efficiency 91 %
 Peak intensity 136 cd/lm
 LEDs/each optic 1
 Light colour White
 Required components:

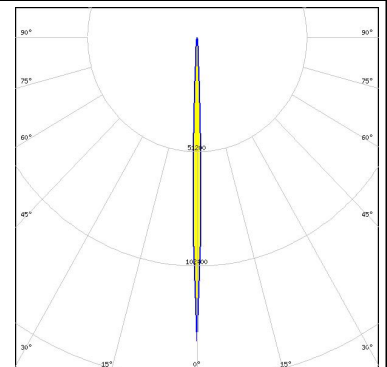

PHOTOMETRIC DATA (SIMULATED):

<p>LUMILEDS</p> <p>LED: LUXEON CZ FWHM / FWTM: 1.4° / 3.7° Efficiency: 94 % Peak intensity: 424 cd/lm LEDs/each optic: 1 Light colour: Green Required components:</p>	
<p>LUMILEDS</p> <p>LED: LUXEON CZ FWHM / FWTM: 1.3° / 3.4° Efficiency: 94 % Peak intensity: 564 cd/lm LEDs/each optic: 1 Light colour: PC Amber Required components:</p>	
<p>LUMILEDS</p> <p>LED: LUXEON CZ FWHM / FWTM: 1.6° / 3.8° Efficiency: 93 % Peak intensity: 371 cd/lm LEDs/each optic: 1 Light colour: Blue Required components:</p>	
<p>LUMILEDS</p> <p>LED: LUXEON CZ FWHM / FWTM: 1.2° / 3.3° Efficiency: 94 % Peak intensity: 564 cd/lm LEDs/each optic: 1 Light colour: Red Required components:</p>	

PHOTOMETRIC DATA (SIMULATED):

<p>LUMILEDS</p> <p>LED: LUXEON CZ</p> <p>FWHM / FWTM: 1.7° / 3.9°</p> <p>Efficiency: 93 %</p> <p>Peak intensity: 346 cd/lm</p> <p>LEDs/each optic: 1</p> <p>Light colour: White</p> <p>Required components:</p>	
<p>LUMILEDS</p> <p>LED: LUXEON HL2X</p> <p>FWHM / FWTM: 2.0° / 4.0°</p> <p>Efficiency: 89 %</p> <p>Peak intensity: 317.8 cd/lm</p> <p>LEDs/each optic: 1</p> <p>Light colour: White</p> <p>Required components:</p>	
<p>LUMILEDS</p> <p>LED: LUXEON M/MX</p> <p>FWHM / FWTM: 3.6° / 9.0°</p> <p>Efficiency: 89 %</p> <p>Peak intensity: 99 cd/lm</p> <p>LEDs/each optic: 1</p> <p>Light colour: White</p> <p>Required components:</p>	
<p>LUMILEDS</p> <p>LED: LUXEON MZ</p> <p>FWHM / FWTM: 2.2° / 6.0°</p> <p>Efficiency: 84 %</p> <p>Peak intensity: 151 cd/lm</p> <p>LEDs/each optic: 1</p> <p>Light colour: White</p> <p>Required components:</p>	

PHOTOMETRIC DATA (SIMULATED):

<p>LUMILEDS</p> <p>LED: LUXEON Rebel</p> <p>FWHM / FWTM: 1.3° / 3.2°</p> <p>Efficiency: 90 %</p> <p>Peak intensity: 704 cd/lm</p> <p>LEDs/each optic: 1</p> <p>Light colour: White</p> <p>Required components:</p>	
<p>LUMILEDS</p> <p>LED: LUXEON Rebel ES</p> <p>FWHM / FWTM: 1.6° / 3.6°</p> <p>Efficiency: 90 %</p> <p>Peak intensity: 530 cd/lm</p> <p>LEDs/each optic: 1</p> <p>Light colour: White</p> <p>Required components:</p>	
<p>LUMILEDS</p> <p>LED: LUXEON Rubix</p> <p>FWHM / FWTM: 2.0° / 6.0°</p> <p>Efficiency: 83 %</p> <p>Peak intensity: 141.9 cd/lm</p> <p>LEDs/each optic: 1</p> <p>Light colour: Blue</p> <p>Required components:</p>	
<p>LUMILEDS</p> <p>LED: LUXEON Rubix</p> <p>FWHM / FWTM: 2.0° / 6.0°</p> <p>Efficiency: 83 %</p> <p>Peak intensity: 157.7 cd/lm</p> <p>LEDs/each optic: 1</p> <p>Light colour: Green</p> <p>Required components:</p>	

PHOTOMETRIC DATA (SIMULATED):

<p>LUMILEDS</p> <p>LED: LUXEON Rubix</p> <p>FWHM / FWTM: 2.0° / 6.0°</p> <p>Efficiency: 85 %</p> <p>Peak intensity: 196.2 cd/lm</p> <p>LEDs/each optic: 1</p> <p>Light colour: Red</p> <p>Required components:</p>	
<p>LUMILEDS</p> <p>LED: LUXEON Rubix</p> <p>FWHM / FWTM: 2.0° / 4.0°</p> <p>Efficiency: 88 %</p> <p>Peak intensity: 290.2 cd/lm</p> <p>LEDs/each optic: 1</p> <p>Light colour: White</p> <p>Required components:</p>	
<p>LUMILEDS</p> <p>LED: LUXEON S1000</p> <p>FWHM / FWTM: 3.8° / 8.0°</p> <p>Efficiency: 88 %</p> <p>Peak intensity: 100 cd/lm</p> <p>LEDs/each optic: 1</p> <p>Light colour: White</p> <p>Required components:</p>	
<p>LUMILEDS</p> <p>LED: LUXEON V2</p> <p>FWHM / FWTM: 2.0° / 4.0°</p> <p>Efficiency: 88 %</p> <p>Peak intensity: 250.1 cd/lm</p> <p>LEDs/each optic: 1</p> <p>Light colour: White</p> <p>Required components:</p>	

PHOTOMETRIC DATA (SIMULATED):

<p>LUMINUS</p> <p>LED: SBT-90 FWHM / FWTM: 2.0° / 6.0° Efficiency: 76 % Peak intensity: 175.9 cd/lm LEDs/each optic: 1 Light colour: White Required components:</p>	
<p>LUMINUS</p> <p>LED: SBT-90 FWHM / FWTM: 2.3° / 4.8° Efficiency: 90 % Peak intensity: 253 cd/lm LEDs/each optic: 1 Light colour: White Required components:</p>	
<p>NICHIA</p> <p>LED: NV4WB35AM FWHM / FWTM: 2.0° / 4.0° Efficiency: 90 % Peak intensity: 185.5 cd/lm LEDs/each optic: 1 Light colour: White Required components:</p>	
<p>NICHIA</p> <p>LED: NVSW219F FWHM / FWTM: 2.0° / 4.0° Efficiency: 89 % Peak intensity: 296 cd/lm LEDs/each optic: 1 Light colour: White Required components:</p>	

PHOTOMETRIC DATA (SIMULATED):

<p>NICHIA</p> <p>LED: NVSW519A FWHM / FWTM: 2.0° / 4.0° Efficiency: 89 % Peak intensity: 251.6 cd/lm LEDs/each optic: 1 Light colour: White Required components:</p>	
<p>OSRAM Opto Semiconductors</p> <p>LED: KW CSLPM1.TG FWHM / FWTM: 2.0° / 4.0° Efficiency: 90 % Peak intensity: 229.3 cd/lm LEDs/each optic: 1 Light colour: White Required components:</p>	
<p>OSRAM Opto Semiconductors</p> <p>LED: KW CULPM1.TG FWHM / FWTM: 2.0° / 6.0° Efficiency: 92 % Peak intensity: 176.8 cd/lm LEDs/each optic: 1 Light colour: White Required components:</p>	
<p>OSRAM Opto Semiconductors</p> <p>LED: OSCONIQ C 2424 FWHM / FWTM: 2.0° / 4.0° Efficiency: 90 % Peak intensity: 241.6 cd/lm LEDs/each optic: 1 Light colour: White Required components:</p>	

PHOTOMETRIC DATA (SIMULATED):

OSRAM <small>Opto Semiconductors</small>	LED OSCONIQ P 3737 (2W version)	
FWHM / FWTM 2.0° / 4.0°	2.0° / 4.0°	
Efficiency 89 %	89 %	
Peak intensity 258.2 cd/lm	258.2 cd/lm	
LEDs/each optic 1	1	
Light colour White	White	
Required components:		
OSRAM <small>Opto Semiconductors</small>	LED OSCONIQ P 3737 (3W version)	
FWHM / FWTM 2.0° / 4.0°	2.0° / 4.0°	
Efficiency 90 %	90 %	
Peak intensity 232.3 cd/lm	232.3 cd/lm	
LEDs/each optic 1	1	
Light colour White	White	
Required components:		
OSRAM <small>Opto Semiconductors</small>	LED OSCONIQ P 7070	
FWHM / FWTM 3.5° / 7.1°	3.5° / 7.1°	
Efficiency 91 %	91 %	
Peak intensity 122.2 cd/lm	122.2 cd/lm	
LEDs/each optic 1	1	
Light colour White	White	
Required components:		
OSRAM <small>Opto Semiconductors</small>	LED OSLOM Square PC	
FWHM / FWTM 1.5° / 3.6°	1.5° / 3.6°	
Efficiency 89 %	89 %	
Peak intensity 550 cd/lm	550 cd/lm	
LEDs/each optic 1	1	
Light colour White	White	
Required components:		

PHOTOMETRIC DATA (SIMULATED):

SAMSUNG

LED LH351B
 FWHM / FWTM 2.0° / 4.0°
 Efficiency 90 %
 Peak intensity 279.4 cd/lm
 LEDs/each optic 1
 Light colour White
 Required components:

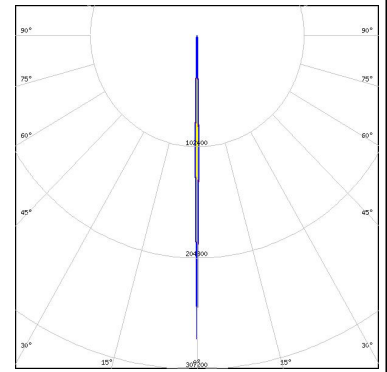

SAMSUNG

LED LH351C
 FWHM / FWTM 2.0° / 4.0°
 Efficiency 91 %
 Peak intensity 279.2 cd/lm
 LEDs/each optic 1
 Light colour White
 Required components:

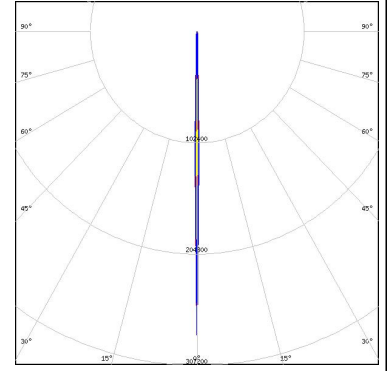

SAMSUNG

LED LH351D
 FWHM / FWTM 2.0° / 4.0°
 Efficiency 91 %
 Peak intensity 235.3 cd/lm
 LEDs/each optic 1
 Light colour White
 Required components:

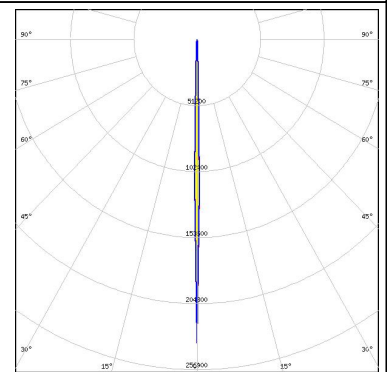

SEOUL SEMICONDUCTOR

LED Z8Y50P
 FWHM / FWTM 3.0° / 7.0°
 Efficiency 79 %
 Peak intensity 90.4 cd/lm
 LEDs/each optic 1
 Light colour White
 Required components:

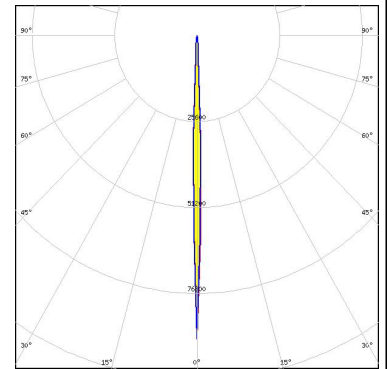

GENERAL INFORMATION:

NOTE: The typical beam angle will be changed by different color, chip size and chip position tolerance. The typical total beam angle is the full angle measured where the luminous intensity is half of the peak value.

MATERIALS:

As part of our continuous research and improvement processes, and to ensure the best possible quality and availability of our products, LEDiL reserves the right to change material grades without notice.

PRODUCT DATA USER AGREEMENT AND DISCLAIMER:

The measured data in the provided downloadable LEDiL Product Datasheets and Mechanical 2D-Drawings is rounded and provided as reference for planning. LEDiL Oy's optical specifications have been verified by conducting performance testing of the products in accordance with the company's quality system. The reported data are averaged results of multiple measurements with typical variation. LEDiL Oy reserves the right to without prior notification make changes and improvements to its products.

LEDiL Oy assumes neither warranty, nor guarantee nor any other liability of any kind for the contents and correctness of the provided data. The provided data has been generated with highest diligence but the provided data may in reality not represent the complete possible variation range of all intrinsic parameters. Therefore, in certain cases a deviation from the provided data could occur.

LEDiL Oy reserves the right to undertake technical changes of its products without further notification which could lead to changes in the provided data. LEDiL Oy assumes no liability of any kind for the possible deviation from any provided data or any other damage resulting from the usage of the provided data.

The user agrees to this disclaimer and user agreement with the download or usage of the provided files.

LEDiL Oy

Joensuunkatu 13
FI-24240 SALO
Finland

LEDiL Inc.

228 West Page Street
Suite D
Sycamore IL 60178
USA

Ledil Optics Technology (Shenzhen) Co., Ltd.

405 , Block B
Casic Motor Building
Shenzhen 518057
P.R.CHINA

Local sales and technical support

[www.ledil.com/
where_to_buy](http://www.ledil.com/where_to_buy)

Shipping locations

Salo, Finland
Hong Kong, China

Distribution Partners

[www.ledil.com/
where_to_buy](http://www.ledil.com/where_to_buy)