

**SPECIFICATION**  
**FOR**  
**LCM Module**

MODULE No:	KD070HDFIA030-01
CUSTOMER:	

STARTEK	INITIAL	DATE
PREPARED BY		
CHECKED BY		
APPROVED BY		

CUSTOMER	INITIAL	DATE
APPROVED BY		



## Contents

1. Block Diagram .....	5
2. Outline dimension .....	6
3. Input terminal Pin Assignment .....	7
4. LCD Optical Characteristics .....	9
4.1 Optical specification .....	9
5. Electrical Characteristics .....	12
5.1 Absolute Maximum Rating .....	12
5.2 DC Electrical Characteristics .....	12
5.3 LED Backlight Characteristics .....	13
6. MIPI AC Characteristic .....	15
6.1 LP Transmitter AC Specification .....	15
6.2 Turnaround Procedure .....	16
6.3 High speed transmission .....	17
6.4 High Speed Clock Transmission .....	18
6.5 High Speed Data Transmission in Bursts .....	19
7. LCD Module Out-Going Quality Level .....	20
7.1 VISUAL & FUNCTION INSPECTION STANDARD .....	20
7.1.1 Inspection conditions .....	20
7.1.2 Definition .....	20
7.1.3 Sampling Plan .....	21
7.1.4 Criteria (Visual) .....	22
8. Reliability Test Result .....	25
9. Cautions and Handling Precautions .....	26
9.1 Handling and Operating the Module .....	26
9.2 Storage and Transportation .....	26
10. Packing .....	27

Part. No	KD070HDFIA030-01	REV	V1.0	Page 3 of 27
	常备库存 Stock For Sale	长期供货 Long Time supply	支持小量 NO MOQ	品种齐全 In Full Range

**\* Description**

This is a color active matrix TFT (Thin Film Transistor) LCD (liquid crystal display) that uses amorphous silicon TFT as a switching device. This module is composed of a Transmissive type TFT-LCD Panel, driver circuit, back-light unit. The resolution of a 7.0 " TFT-LCD contains 1024x600 pixels, and can display up to 16.7M colors.

**\* Features**

General Information Items	Specification	Unit	Note
	Main Panel		
Display area(AA)	154.21(H)*85.92 (V) (7.0inch)	mm	
Driver element	TFT active matrix	-	
Display colors	16.7M	colors	
Number of pixels	1024(RGB)*600	dots	
Pixel arrangement	RGB vertical stripe	-	
Pixel pitch	0.1506(H)*0.1432(V)	mm	
Viewing angle	Free	o'clock	
Controller IC	EK73217BCGA+EK79007AD2	-	
LCM Interface	4Lane MIPI	-	
Display mode	Transmissive /Normally Black	-	
Operating temperature	-20~+70	°C	
Storage temperature	-30~+80	°C	

**\* Mechanical Information**

Item		Min.	Typ.	Max.	Unit	Note
Module size	Horizontal(H)	-	165	-	mm	
	Vertical(V)	-	100	-	mm	
	Depth(D)	-	5.8	-	mm	
Weight		-	--	-	g	

Part. No	KD070HDFIA030-01	REV	V1.0	Page 4 of 27
常备库存 Stock For Sale	长期供货 Long Time supply	支持小量 NO MOQ	品种齐全 In Full Range	

### 1. Block Diagram

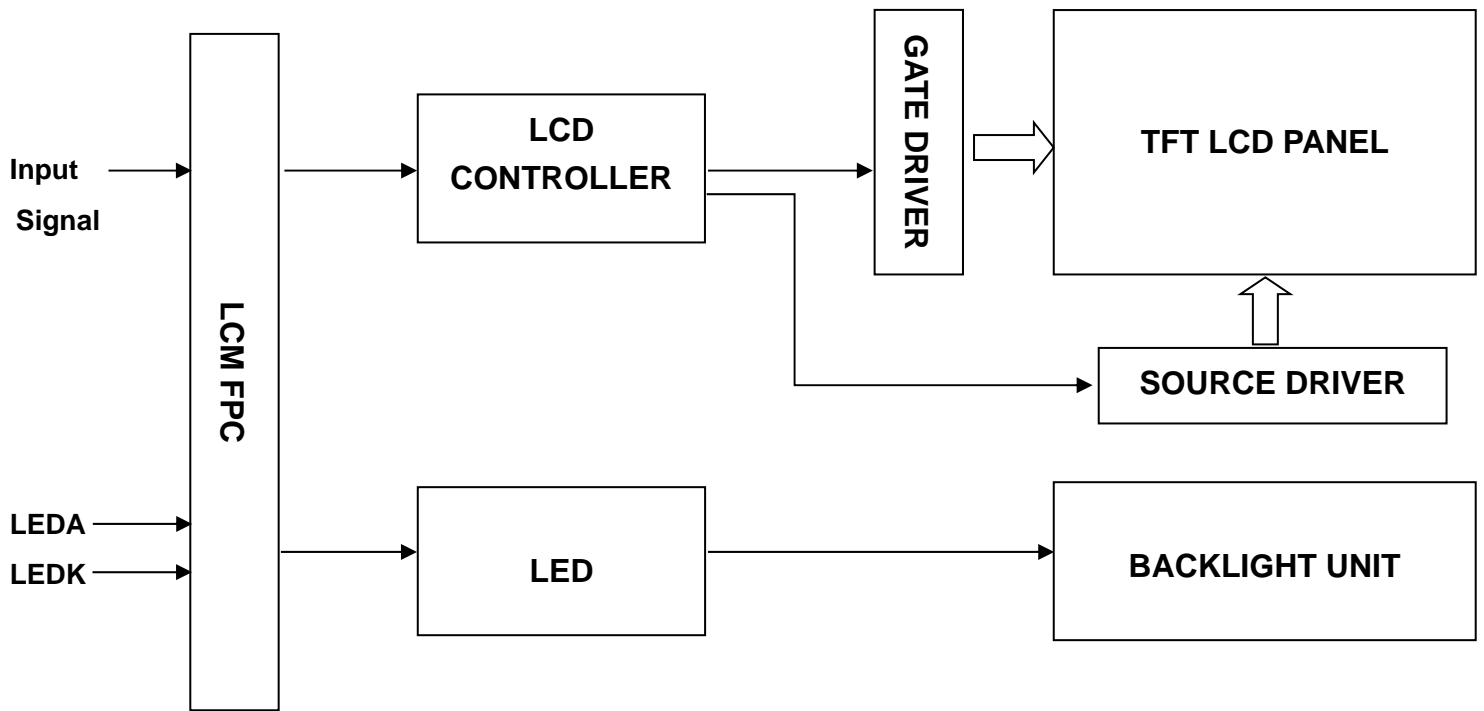

Part. No	KD070HDFIA030-01	REV	V1.0	Page 5 of 27
常备库存 Stock For Sale	长期供货 Long Time supply	支持小量 NO MOQ	品种齐全 In Full Range	



### 3. Input terminal Pin Assignment

NO.	SYMBOL	DISCRIPTION	I/O
1	LEDK	LED Cathode	P
2	LEDK	LED Cathode	P
3	NC		
4	LEDA	LED Anode	P
5	LEDA	LED Anode	P
6	NC		
7	VDD_1.8V	Power supply for digital circuits	P
8	NC		
9	VDD_3.3V	Power supply for DC/DC convert circuit	P
10	UD	Vertical shift direction (gate output) selection(NOTE1)	I
11	LR	Horizontal shift direction (source output) selection(NOTE1)	I
12	RESET	Global reset pin. Active low to enter reset state.	I
13	STBYB	Standby mode, Normally pulled high STBYB = "1", normal operation STBYB = "0", timing controller, source driver will turn off, all output are High-Z.	I
14	GND	Ground	P
15	D0N	MIPI DSI differential data pair (Data lane 0)	I/O
16	D0P		
17	GND	Ground	P
18	D1N	MIPI DSI differential data pair (Data lane 1)	I/O
19	D1P		
20	GND	Ground	P
21	CLKN	MIPI DSI differential clock pair .	I
22	CLKP		
23	GND	Ground	P
24	D2N	MIPI DSI differential data pair (Data lane 2)	I/O
25	D2P		
26	GND	Ground	P
27	D3N	MIPI DSI differential data pair (Data lane 3)	I/O

Part. No	KD070HDFIA030-01	REV	V1.0	Page 7 of 27
常备库存 Stock For Sale	长期供货 Long Time supply	支持小量 NO MOQ	品种齐全 In Full Range	

28	D3P	MIPI DSI differential data pair (Data lane 3)	
29	GND	Ground	P
30	GND	Ground	P

Note1: When L/R="0", set right to left scan direction.

When L/R="1", set left to right scan direction.

When U/D="0", set top to bottom scan direction.

When U/D="1", set bottom to top scan direction.

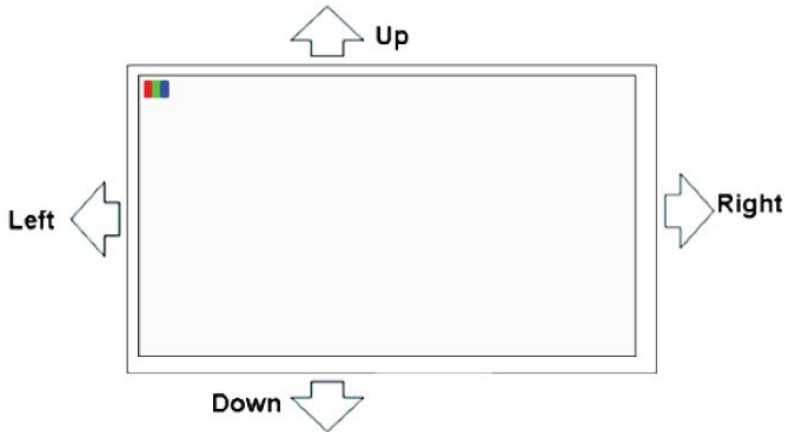

Part. No	KD070HDFIA030-01	REV	V1.0	Page 8 of 27
	常备库存 Stock For Sale	长期供货 Long Time supply	支持小量 NO MOQ	品种齐全 In Full Range



## 4. LCD Optical Characteristics

### 4.1 Optical specification

Item	Symbol	Condition	Min.	Typ.	Max.	Unit.	Note
Contrast Ratio	CR	$\Theta=0$	600	800	--		(1)(2)
Response time	Rising	Normal viewing angle	--	25	40	msec	(1)(3)
	Falling						
Uniformity	S(%)		--	50	--	%	
Color Filter Chromacicity	White	$W_X$	$\Theta = 0^\circ$	0.2584	0.2984	0.3384	(1)(4)
		$W_Y$		0.3000	0.3400	0.3800	
	Red	$R_X$		0.5731	0.5931	0.6131	
		$R_Y$		0.3352	0.3552	0.3752	
	Green	$G_X$		0.2909	0.3109	0.2909	
		$G_Y$		0.5344	0.5544	0.5744	
	Blue	$B_X$		0.1334	0.1534	0.1734	
		$B_Y$		0.0872	0.1072	0.1272	
Viewing angle	Hor.	$\Theta_L$	CR>10	--	85	--	(1)(4)
		$\Theta_R$		--	85	--	
	Ver.	$\Theta_U$		--	85	--	
		$\Theta_D$		--	85	--	
Option View Direction	FREE						

#### Measuring Condition

Measuring surrounding : dark room

Ambient temperature : 25±2°C

15min. warm-up time.

#### Measuring Equipment

FPM520 of Westar Display technologies, INC., which utilized SR-3 for Chromaticity and BM-5A for other optical characteristics.

Part. No	KD070HDFIA030-01	REV	V1.0	Page 9 of 27
常备库存 Stock For Sale	长期供货 Long Time supply	支持小量 NO MOQ	品种齐全 In Full Range	

**Note (1):** Definition of Viewing Angle :

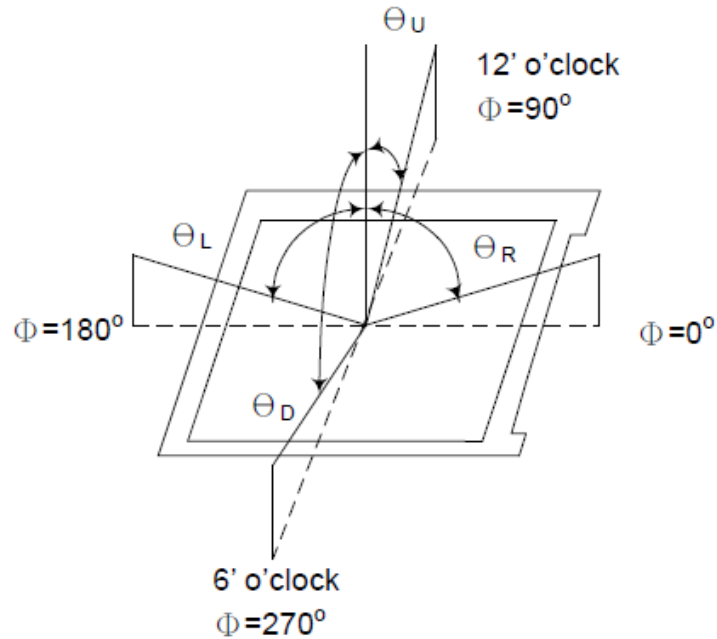

**Note (2):** Definition of Contrast Ratio(CR) :measured at the center point of panel

$$CR = \frac{\text{Luminance with all pixels white}}{\text{Luminance with all pixels black}}$$

**Note (3):** Response Time

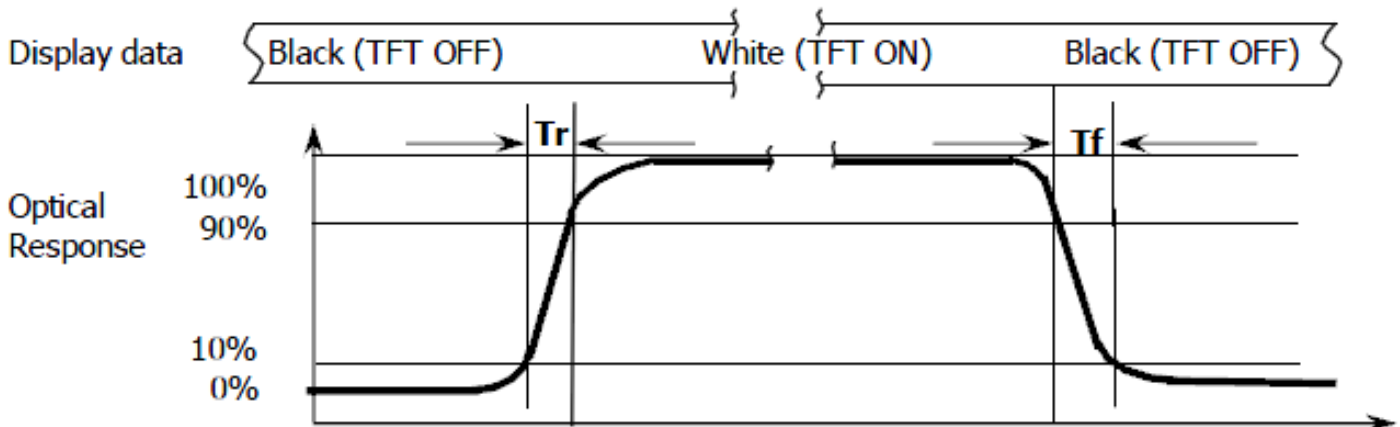

Part. No	KD070HDFIA030-01	REV	V1.0	Page 10 of 27
常备库存 Stock For Sale	长期供货 Long Time supply	支持小量 NO MOQ	品种齐全 In Full Range	

**Note (4):** Definition of optical measurement setup

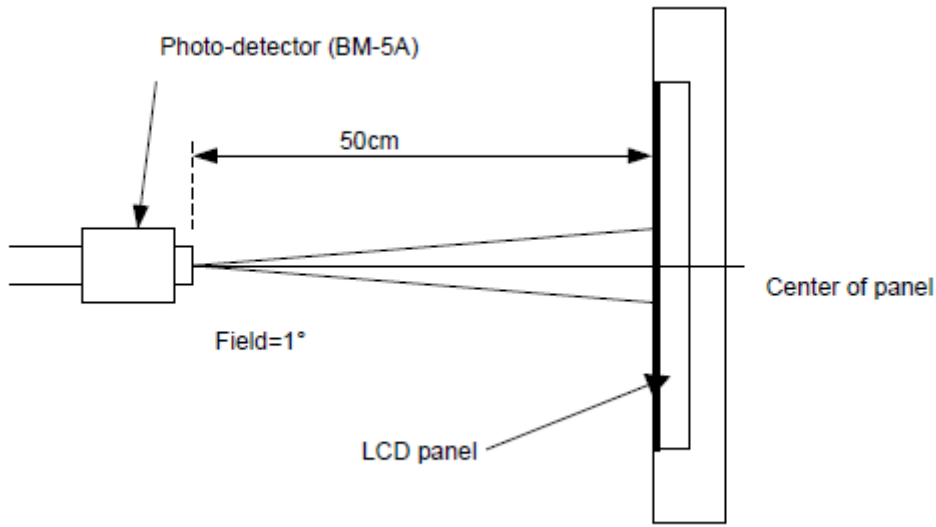

Part. No	KD070HDFIA030-01	REV	V1.0	Page 11 of 27
常备库存 Stock For Sale	长期供货 Long Time supply	支持小量 NO MOQ	品种齐全 In Full Range	

## 5. Electrical Characteristics

### 5.1 Absolute Maximum Rating

Characteristics	Symbol	Min.	Max.	Unit	Note
Power supply for digital circuits	VDD_1.8V	-0.3	2.0	V	Note1
Power supply for DC/DC convert circuit	VDD_3.3V	-0.3	6.0	V	Note1
Operating temperature	T <sub>OP</sub>	-20	+70	°C	
Storage temperature	T <sub>ST</sub>	-30	+80	°C	

NOTE1: If the absolute maximum rating of even is one of the above parameters is exceeded even momentarily, the quality of the product may be degraded. Absolute maximum ratings, therefore, specify the values exceeding which the product may be physically damaged. Be sure to use the product within the range of the absolute maximum ratings.

### 5.2 DC Electrical Characteristics

Characteristics	Symbol	Min.	Typ.	Max.	Unit	Note
Power supply for digital circuits	VDD_1.8V	1.71	1.8	1.89	V	
Power supply for DC/DC convert circuit	VDD_3.3V	2.7	3.3	5.8	V	
Normal mode Current	IDD_1.8V	--	0.05	--	mA	
Normal mode Current	IDD_3.3V	--	140	--	mA	
Low Level input voltage	V <sub>IH</sub>	0.7*VDD_1.8V	--	VDD_1.8V	V	
	V <sub>IL</sub>	0	--	0.3*VDD_1.8V	V	

Part. No	KD070HDFIA030-01	REV	V1.0	Page 12 of 27
常备库存 Stock For Sale	长期供货 Long Time supply	支持小量 NO MOQ	品种齐全 In Full Range	

High Level output voltage	V <sub>OH</sub>	VDD_1.8 V-0.4	--	VDD_1.8 V	V	
	V <sub>OL</sub>	0	--	0.4	V	

### 5.3 LED Backlight Characteristics

The back-light system is edge-lighting type with 27 chips LED

Item	Symbol	Min.	Typ.	Max.	Unit	Note
Forward Current	I <sub>F</sub>	180	540	--	mA	
Forward Voltage	V <sub>F</sub>	--	9.6	--	V	
LCM Luminance (I <sub>F</sub> =270mA)	LV	850	900	--	cd/m <sup>2</sup>	Note3
LCM Luminance (I <sub>F</sub> =540mA)	LV	1650	1700	--	cd/m <sup>2</sup>	Note3
LED life time	Hr	--	50000	--	Hour	Note1,2
Uniformity	Avg	80	--	--	%	Note3

Note1: LED life time (Hr) can be defined as the time in which it continues to operate under the condition:

T<sub>a</sub>=25±3 °C, typical IL value indicated in the above table until the brightness becomes less than 50%.

Note 2: The “LED life time” is defined as the module brightness decrease to 50% original brightness at

T<sub>a</sub>=25°C and I<sub>L</sub>=540mA. The LED lifetime could be decreased if operating I<sub>L</sub> is larger than 540mA. The constant current driving method is suggested.

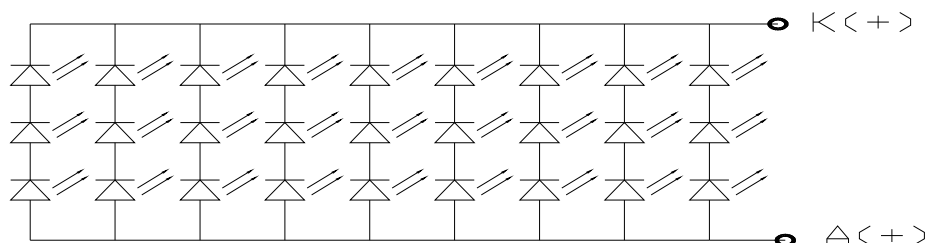

B/L Circuit

Part. No	KD070HDFIA030-01	REV	V1.0	Page 13 of 27
常备库存 Stock For Sale	长期供货 Long Time supply	支持小量 NO MOQ	品种齐全 In Full Range	

Note (3) Luminance Uniformity of these 9 points is defined as below:

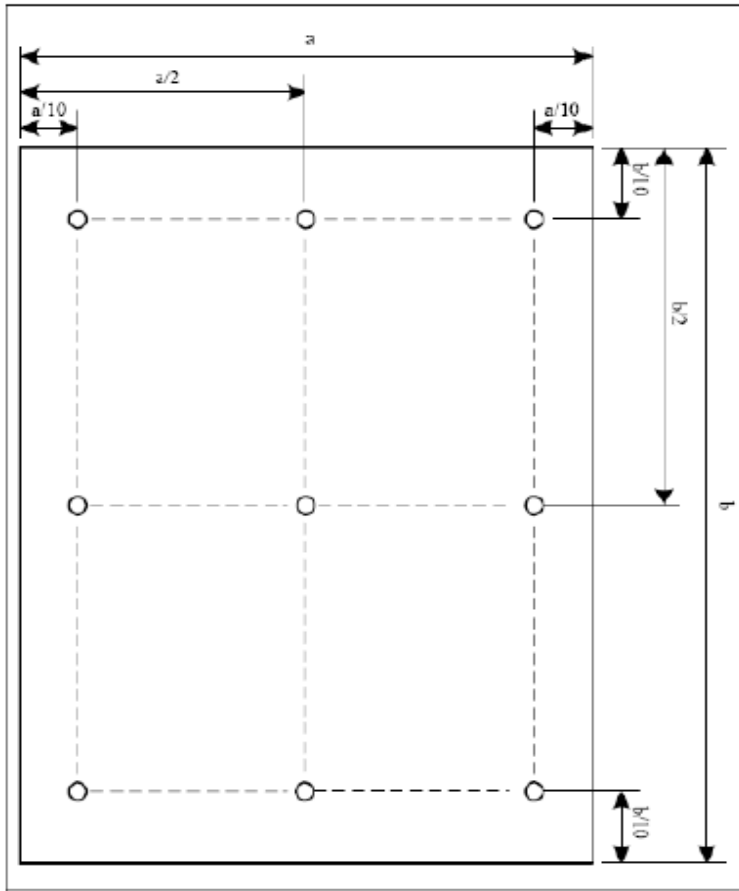

$$\text{Uniformity} = \frac{\text{minimum luminance in 9 points (1-9)}}{\text{maximum luminance in 9 points (1-9)}}$$

$$\text{Luminance} = \frac{\text{Total Luminance of 9 points}}{9}$$

Part. No	KD070HDFIA030-01	REV	V1.0	Page 14 of 27
常备库存 Stock For Sale	长期供货 Long Time supply	支持小量 NO MOQ	品种齐全 In Full Range	

## 6. MIPI AC Characteristic

### 6.1 LP Transmitter AC Specification

Parameter	Symbol	Min	Typ	Max	Units	Notes
15%~85% rising time and falling time	$T_{RLP} / T_{FLP}$	-	-	25	ns	-
30%~85% rising time and falling time	$T_{REOT}$	-	-	35	ns	-
Pulse width of LP exclusive-OR clock	First LP EXOR clock pulse after STOP state or Last pulse before stop state	40	-	-	ns	-
	All other pulses	20	-	-	ns	-
Period of the LP EXOR clock	$T_{LP-PER-TX}$	90	-	-	mV/ns	-
Slew Rate @CLOAD =0pF	$\delta V / \delta t_{SR}$	30	-	500	mV/ns	-
Slew Rate @CLOAD =5pF		30	-	200	mV/ns	-
Slew Rate @CLOAD =20pF		30	-	150	mV/ns	-
Slew Rate @CLOAD =70pF		30	-	100	mV/ns	-
Load Capacitance	$T_{RLP}$	-	-	70	pF	-

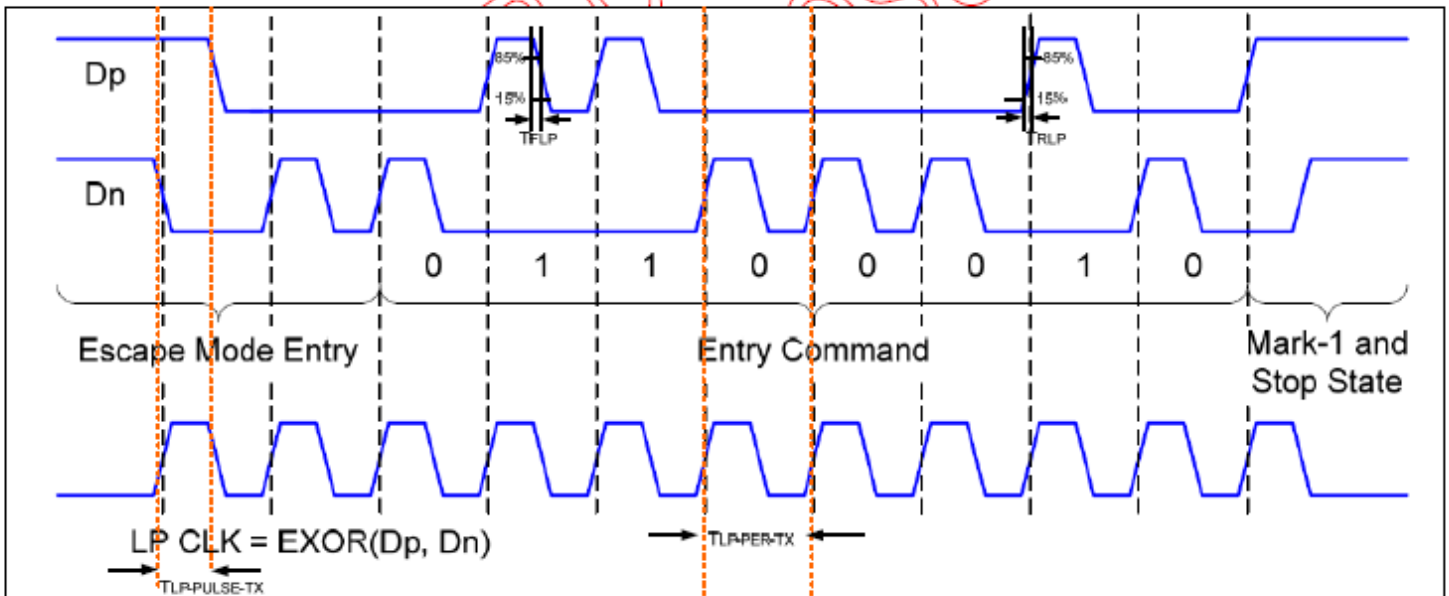

Part. No	KD070HDFIA030-01	REV	V1.0	Page 15 of 27
常备库存 Stock For Sale	长期供货 Long Time supply	支持小量 NO MOQ	品种齐全 In Full Range	

## 6.2 Turnaround Procedure

Turnaround Procedure Operation Timing Parameters

Parameter	Symbol	Min	Typ	Max	Units
Length of any Low-Power state period: Master side	$T_{LPX}$	50	-	75	ns
Length of any Low-Power state period: Slave side	$T_{LPX}$	50	55.56	58.34	ns
Ratio of $T_{LPX}$ (Master)/ $T_{LPX}$ (Slave) between Master and Slave side	Ratio $T_{LPX}$	2/3	-	3/2	
Time-out before new TX side start driving	$T_{TA-Sure}$	$T_{LPX}$	-	$2T_{LPX}$	ns
Time to drive LP-00 by new TX	$T_{TA-GET}$	-	$5T_{LPX}$	-	ns
Time to drive LP-00 after Turnaround Request	$T_{TA-GO}$	-	$4T_{LPX}$	-	ns

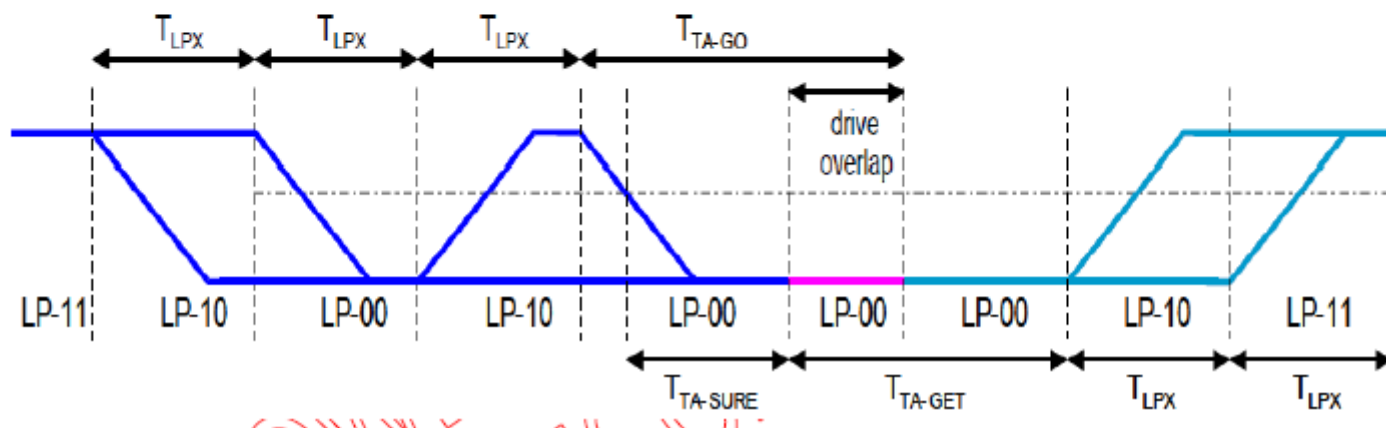



### 6.3 High speed transmission

Parameter	Symbol	Min	Typ	Max	Units
UI instantaneous	$U_{INST}$	2	-	12.5	ns
Data to Clock Skew(measured at transmitter)	$T_{SKEW(TX)}$	-0.15	-	0.15	$U_{INST}$
Data to Clock Setup time(measured at receiver)	$T_{SETUP(RX)}$	0.15	-	-	$U_{INST}$
Data to Clock Hold time(measured at receiver)	$T_{HOLD(RX)}$	0.15	-	-	$U_{INST}$
20%~80% rise time and fall time	$T_R, T_F$	150	-	-	ps
		-	-	0.3	$U_{INST}$

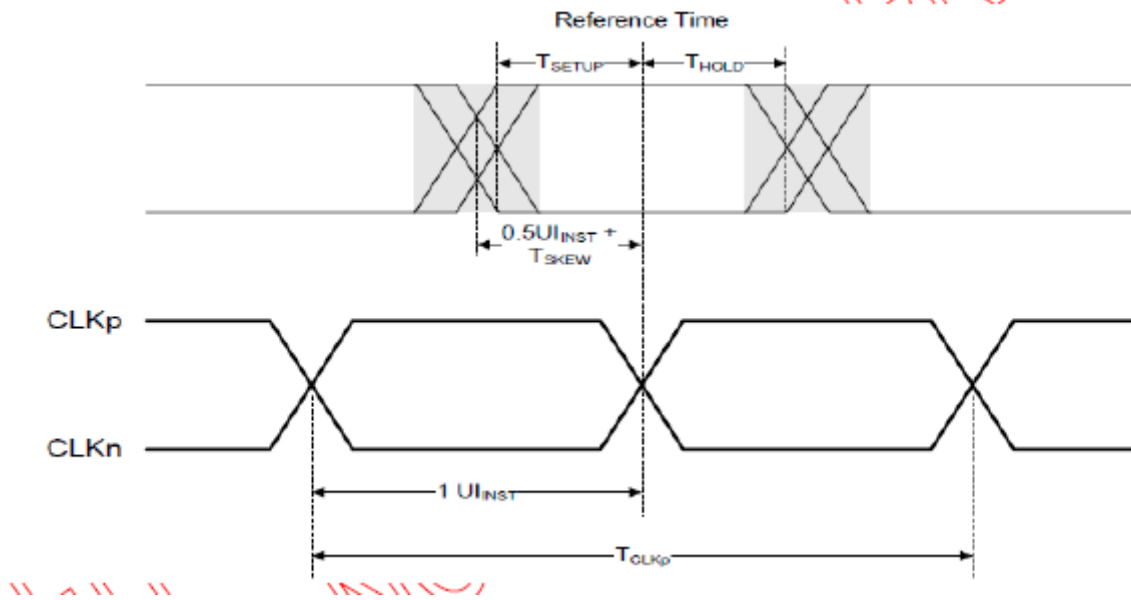

### 6.4 High Speed Clock Transmission

Parameter	Symbol	Min	Typ	Max	Units
Time that the transmitter shall continue sending HS clock after the last associated Data Lane has transitioned to LP mode	TCLK-POST	60+52UI	-	-	ns
Detection time that the clock has stopped toggling	TCLK-MISS	-	-	60	ns
Time to drive LP-00 to prepare for HS clock transmission	TCLK-PREPARE	38	-	95	ns
Minimum lead HS-0 drive period before starting clock	TCLK-PREPARE + TCLK-ZERO	300	-	-	ns
Time to enable Clock Lane receiver line termination measured from when Dn cross $V_{IL,MAX}$	THS-TERM-EN	-	-	38	ns
Minimum time that the HS clock must be prior to any associated data lane beginning the transmission from LP to HS mode	TCLK-PRE	8	-	-	UI
Time to drive HS differential state after last payload clock bit of a HS transmission burst	TCLK-TRAIL	60	-	-	ns

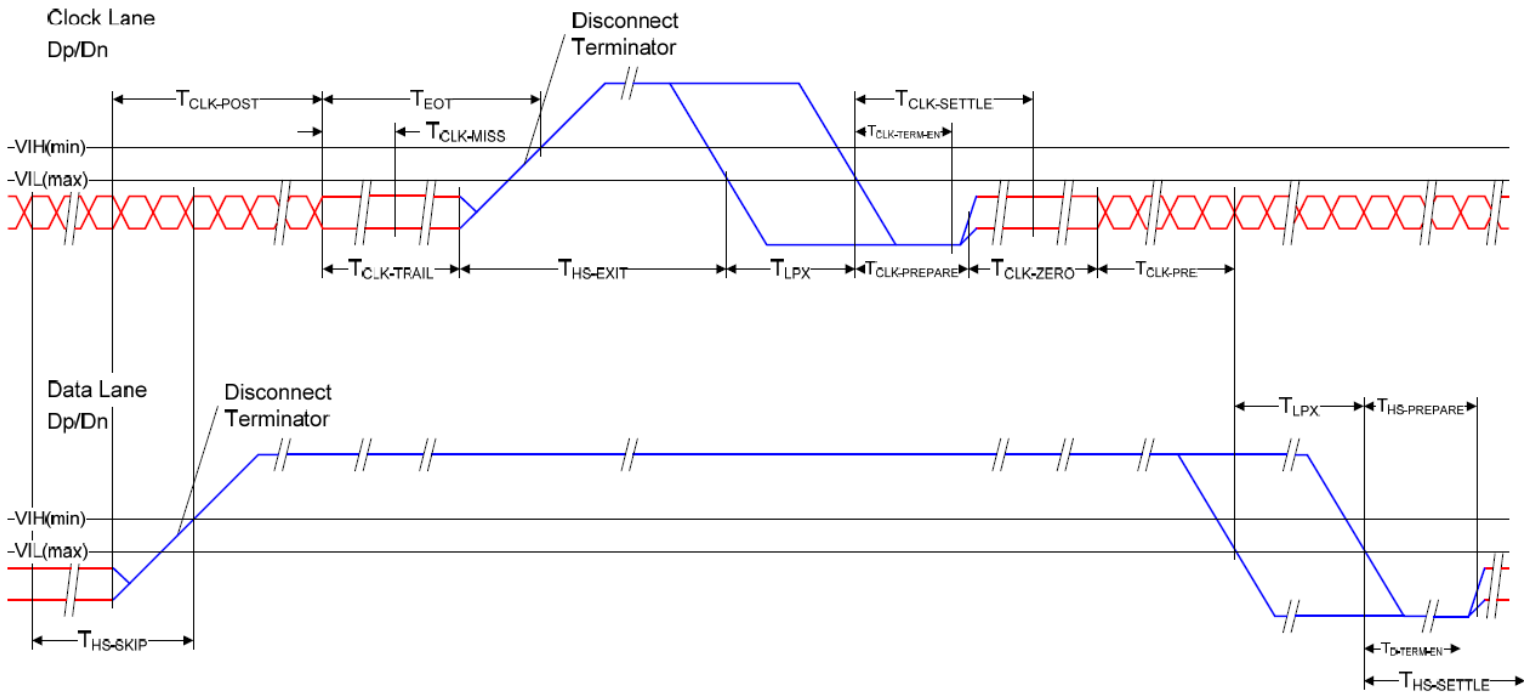

### 6.5 High Speed Data Transmission in Bursts

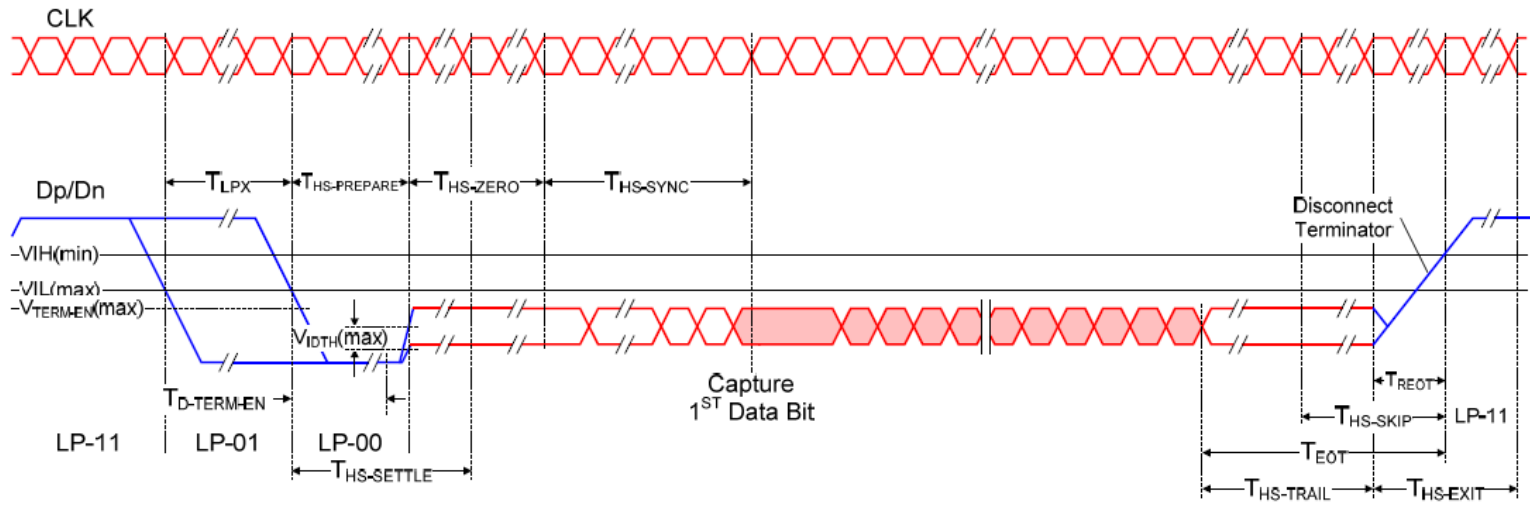

Part. No	KD070HDFIA030-01	REV	V1.0	Page 19 of 27
常备库存 Stock For Sale	长期供货 Long Time supply	支持小量 NO MOQ	品种齐全 In Full Range	

## 7. LCD Module Out-Going Quality Level

### 7.1 VISUAL & FUNCTION INSPECTION STANDARD

#### 7.1.1 Inspection conditions

Inspection performed under the following conditions is recommended.

Temperature : 25±5°C

Humidity : 65%±10%RH

Viewing Angle : Normal viewing Angle.

Illumination: Single fluorescent lamp (300 to 700Lux)

Viewing distance:30-50cm

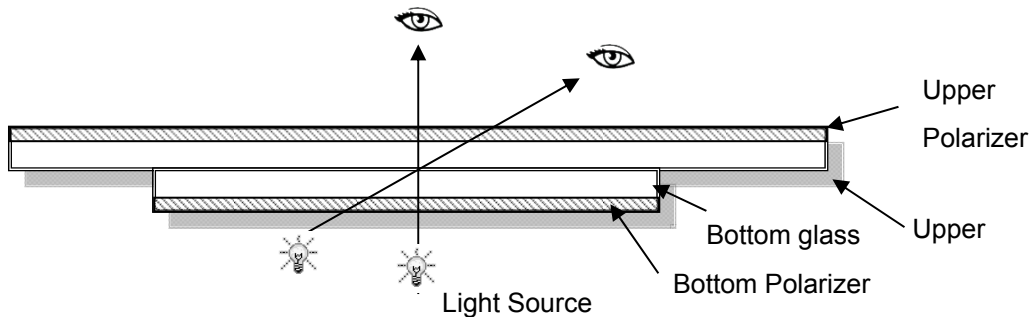

#### 7.1.2 Definition

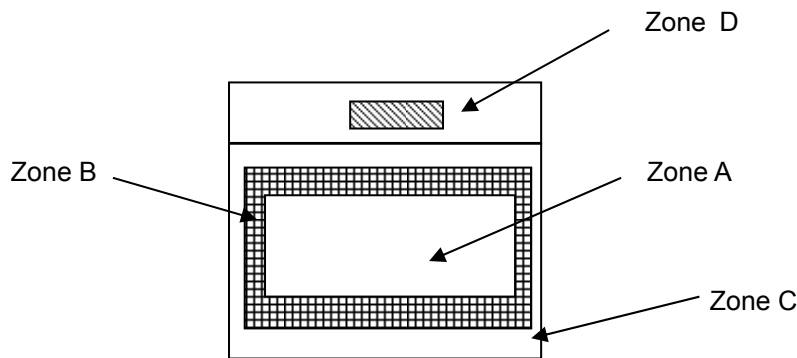

Zone A : Effective Viewing Area(Character or Digit can be seen)

Zone B : Viewing Area except Zone A

Zone C : Outside (Zone A+Zone B) which can not be seen after assembly by customer .)

Zone D : IC Bonding Area

Note:As a general rule ,visual defects in Zone C can be ignored when it doesn't effect product function or appearance after assembly by customer

Part. No	KD070HDFIA030-01	REV	V1.0	Page 20 of 27
常备库存 Stock For Sale	长期供货 Long Time supply		支持小量 NO MOQ	品种齐全 In Full Range

### 7.1.3 Sampling Plan

According to GB/T 2828.1-2003 ; , normal inspection, Class II

AQL:

Major defect	Minor defect
0.65	1.5

LCD: Liquid Crystal Display , TP: Touch Panel , LCM: Liquid Crystal Module

No	Items to be inspected	Criteria	Classification of defects
1	Functional defects	1) No display, Open or miss line 2) Display abnormally, Short 3) Backlight no lighting, abnormal lighting. 4) TP no function	Major
2	Missing	Missing component	
3	Outline dimension	Overall outline dimension beyond the drawing is not allowed	
4	Color tone	Color unevenness, refer to limited sample	Minor
5	Spot Line defect	Light dot, Dim spot,Polarizer Bubble ; Polarizer accidented spot.	
6	Soldering appearance	Good soldering , Peeling off is not allowed.	
7	LCD/Polarizer/TP	Black/White spot/line, scratch, crack, etc.	

### 7.1.4 Criteria (Visual)

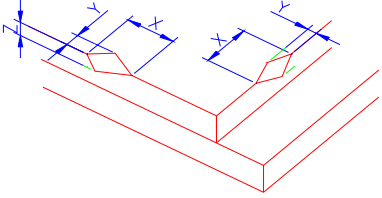
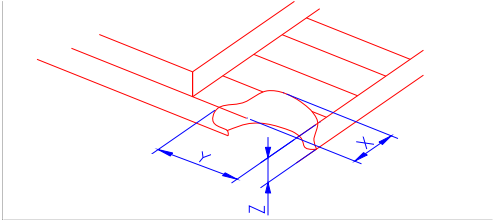
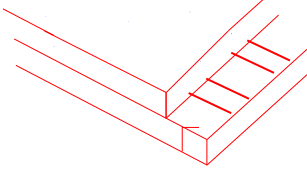
Number	Items	Criteria(mm)						
1.0 LCD Crack/Broken NOTE: X: Length Y: Width Z: Height L: Length of ITO, T: Height of LCD	(1) The edge of LCD broken	 <table border="1" data-bbox="756 667 1455 817"> <thead> <tr> <th>X</th> <th>Y</th> <th>Z</th> </tr> </thead> <tbody> <tr> <td>≤3.0mm</td> <td>&lt;Inner border line of the seal</td> <td>≤T</td> </tr> </tbody> </table>	X	Y	Z	≤3.0mm	<Inner border line of the seal	≤T
X	Y	Z						
≤3.0mm	<Inner border line of the seal	≤T						
	(2)LCD corner broken	 <table border="1" data-bbox="836 1122 1375 1223"> <thead> <tr> <th>X</th> <th>Y</th> <th>Z</th> </tr> </thead> <tbody> <tr> <td>≤3.0mm</td> <td>≤L</td> <td>≤T</td> </tr> </tbody> </table>	X	Y	Z	≤3.0mm	≤L	≤T
X	Y	Z						
≤3.0mm	≤L	≤T						
	(3) LCD crack	 <p style="text-align: center;">Crack Not allowed</p>						



2.0	<p>Spot defect</p> <p><math>\Phi = (X+Y)/2</math></p>	① light dot (LCD/TP/Polarizer black/white spot , light dot, pinhole, dent, stain)																									
		<table border="1"> <thead> <tr> <th rowspan="2">Zone Size (mm)</th> <th colspan="3">Acceptable Qty</th> </tr> <tr> <th>A</th> <th>B</th> <th>C</th> </tr> </thead> <tbody> <tr> <td><math>\Phi \leq 0.10</math></td> <td colspan="3">Ignore</td> </tr> <tr> <td><math>0.10 &lt; \Phi \leq 0.25</math></td> <td colspan="3">4( distance <math>\geq 10\text{mm}</math>)</td> </tr> <tr> <td><math>0.25 &lt; \Phi \leq 0.35</math></td> <td colspan="3">3</td> </tr> <tr> <td><math>\Phi &gt; 0.4</math></td> <td colspan="3">0</td> </tr> </tbody> </table>			Zone Size (mm)	Acceptable Qty			A	B	C	$\Phi \leq 0.10$	Ignore			$0.10 < \Phi \leq 0.25$	4( distance $\geq 10\text{mm}$ )			$0.25 < \Phi \leq 0.35$	3			$\Phi > 0.4$	0		
		Zone Size (mm)	Acceptable Qty																								
			A	B	C																						
		$\Phi \leq 0.10$	Ignore																								
$0.10 < \Phi \leq 0.25$	4( distance $\geq 10\text{mm}$ )																										
$0.25 < \Phi \leq 0.35$	3																										
$\Phi > 0.4$	0																										
② Dim spot (LCD/TP/Polarizer dim dot, light leakage, dark spot)																											
<table border="1"> <thead> <tr> <th rowspan="2">Zone Size (mm)</th> <th colspan="3">Acceptable Qty</th> </tr> <tr> <th>A</th> <th>B</th> <th>C</th> </tr> </thead> <tbody> <tr> <td><math>\Phi \leq 0.1</math></td> <td colspan="3">Ignore</td> </tr> <tr> <td><math>0.10 &lt; \Phi \leq 0.25</math></td> <td colspan="3">4( distance <math>\geq 10\text{mm}</math>)</td> </tr> <tr> <td><math>0.25 &lt; \Phi \leq 0.35</math></td> <td colspan="3">3</td> </tr> <tr> <td><math>\Phi &gt; 0.4</math></td> <td colspan="3">0</td> </tr> </tbody> </table>			Zone Size (mm)	Acceptable Qty			A	B	C	$\Phi \leq 0.1$	Ignore			$0.10 < \Phi \leq 0.25$	4( distance $\geq 10\text{mm}$ )			$0.25 < \Phi \leq 0.35$	3			$\Phi > 0.4$	0				
Zone Size (mm)	Acceptable Qty																										
	A	B	C																								
$\Phi \leq 0.1$	Ignore																										
$0.10 < \Phi \leq 0.25$	4( distance $\geq 10\text{mm}$ )																										
$0.25 < \Phi \leq 0.35$	3																										
$\Phi > 0.4$	0																										
③ Polarizer accidented spot																											
<table border="1"> <thead> <tr> <th rowspan="2">Zone Size (mm)</th> <th colspan="3">Acceptable Qty</th> </tr> <tr> <th>A</th> <th>B</th> <th>C</th> </tr> </thead> <tbody> <tr> <td><math>\Phi \leq 0.2</math></td> <td colspan="3">Ignore</td> </tr> <tr> <td><math>0.3 &lt; \Phi \leq 0.5</math></td> <td colspan="3">3( distance <math>\geq 10\text{mm}</math>)</td> </tr> <tr> <td><math>\Phi &gt; 0.5</math></td> <td colspan="3">1</td> </tr> </tbody> </table>			Zone Size (mm)	Acceptable Qty			A	B	C	$\Phi \leq 0.2$	Ignore			$0.3 < \Phi \leq 0.5$	3( distance $\geq 10\text{mm}$ )			$\Phi > 0.5$	1								
Zone Size (mm)	Acceptable Qty																										
	A	B	C																								
$\Phi \leq 0.2$	Ignore																										
$0.3 < \Phi \leq 0.5$	3( distance $\geq 10\text{mm}$ )																										
$\Phi > 0.5$	1																										
④ Pixel bad points (light dot, Dim dot, color dot)																											
<table border="1"> <thead> <tr> <th rowspan="2">Zone Size (mm)</th> <th colspan="3">Acceptable Qty</th> </tr> <tr> <th>A</th> <th>B</th> <th>C</th> </tr> </thead> <tbody> <tr> <td><math>\Phi \leq 0.15</math></td> <td colspan="3">Ignore</td> </tr> <tr> <td><math>0.2 &lt; \Phi \leq 0.3</math></td> <td colspan="3">2( distance <math>\geq 10\text{mm}</math>)</td> </tr> <tr> <td><math>\Phi &gt; 0.4</math></td> <td colspan="3">1</td> </tr> </tbody> </table>			Zone Size (mm)	Acceptable Qty			A	B	C	$\Phi \leq 0.15$	Ignore			$0.2 < \Phi \leq 0.3$	2( distance $\geq 10\text{mm}$ )			$\Phi > 0.4$	1								
Zone Size (mm)	Acceptable Qty																										
	A	B	C																								
$\Phi \leq 0.15$	Ignore																										
$0.2 < \Phi \leq 0.3$	2( distance $\geq 10\text{mm}$ )																										
$\Phi > 0.4$	1																										
⑤ Polarizer Bubble																											
<table border="1"> <thead> <tr> <th rowspan="2">Zone Size (mm)</th> <th colspan="3">Acceptable Qty</th> </tr> <tr> <th>A</th> <th>B</th> <th>C</th> </tr> </thead> <tbody> <tr> <td><math>\Phi \leq 0.2</math></td> <td colspan="3">Ignore</td> </tr> <tr> <td><math>0.3 &lt; \Phi \leq 0.4</math></td> <td colspan="3">4(distance <math>\geq 10\text{mm}</math>)</td> </tr> <tr> <td><math>0.4 &lt; \Phi \leq 0.5</math></td> <td colspan="3">3</td> </tr> <tr> <td><math>\Phi &gt; 0.5</math></td> <td colspan="3">1</td> </tr> </tbody> </table>			Zone Size (mm)	Acceptable Qty			A	B	C	$\Phi \leq 0.2$	Ignore			$0.3 < \Phi \leq 0.4$	4(distance $\geq 10\text{mm}$ )			$0.4 < \Phi \leq 0.5$	3			$\Phi > 0.5$	1				
Zone Size (mm)	Acceptable Qty																										
	A	B	C																								
$\Phi \leq 0.2$	Ignore																										
$0.3 < \Phi \leq 0.4$	4(distance $\geq 10\text{mm}$ )																										
$0.4 < \Phi \leq 0.5$	3																										
$\Phi > 0.5$	1																										

3.0	Line defect (LCD/TP /Polarizer backlight black/white line, scratch, stain)	Width(mm)	Length(m)	Acceptable Qty		
				A	B	C
		$\Phi \leq 0.05$	Ignore	Ignore		
		$0.05 < W \leq 0.06$	$L \leq 5.0$	$N \leq 3$		
		$0.07 < W \leq 0.08$	$L \leq 4.0$	$N \leq 2$		
	$0.08 < W$	Define as spot defect				
4.0	Electronic Components SMT	Not allow missing parts, solderless connection, cold solder joint, mismatch, The positive and negative polarity opposite				
5.0	Display color & Brightness	1. Color: Measuring the color coordinates, The measurement standard according to the datasheet or samples. 2. Brightness: Measuring the brightness of White screen, The measurement standard according to the datasheet or Samples.				
6.0	LCD Mura	By 5% ND filter invisible.				

Criteria ( functional items)

Number	Items	Criteria (mm)
1	No display	Not allowed
2	Missing segment	Not allowed
3	Short	Not allowed
4	Backlight no lighting	Not allowed
5	TP no function	Not allowed



## 8. Reliability Test Result

Item	Condition	Inspection after test
High Temperature Operating	70℃,96H	Inspection after 2~4hours storage at room temperature, the sample shall be free from defects: 1.Air bubble in the LCD; 2.Non-display; 3.Missing segments/line; 4.Glass crack; 5.Current IDD is twice higher than initial value.
Low Temperature Operating	-20℃, 96HR	
High Temperature Storage	80℃, 96HR	
Low Temperature Storage	-30℃, 96HR	
High Temperature & High Operating	+60℃, 90% RH ,96 hours.	
Thermal Shock (Non-operation)	-30℃,30 min ↔ 80℃,30 min, Change time:5min 20CYC.	
ESD test	C=150pF, R=330,5points/panel Air:±8KV, 5times; Contact:±6KV, 5 times; (Environment: 15℃~35℃, 30%~60%).	
Vibration (Non-operation)	Frequency range:10~55Hz, Stroke:1.5mm Sweep:10Hz~55Hz~10Hz 2 hours for each direction of X.Y.Z. (6 hours for total) (Package condition).	
Box Drop Test	1 Corner 3 Edges 6 faces,80cm(MEDIUM BOX)	

Remark:

- 1.The test samples should be applied to only one test item.
- 2.Sample size for each test item is 5~10pcs.
- 3.For Damp Proof Test, Pure water(Resistance > 10MΩ) should be used.
- 4.In case of malfunction defect caused by ESD damage, if it would be recovered to normal state after resetting, it would be judged as a good part.
- 5.Failure Judgment Criterion: Basic Specification, Electrical Characteristic, Mechanical Characteristic, Optical Characteristic.

Part. No	KD070HDFIA030-01	REV	V1.0	Page 25 of 27
常备库存 Stock For Sale	长期供货 Long Time supply	支持小量 NO MOQ	品种齐全 In Full Range	

## 9. Cautions and Handling Precautions

### 9.1 Handling and Operating the Module

(1) When the module is assembled, it should be attached to the system firmly.

Do not warp or twist the module during assembly work.

(2) Protect the module from physical shock or any force. In addition to damage, this may cause improper operation or damage to the module and back-light unit.

(3) Note that polarizer is very fragile and could be easily damaged. Do not press or scratch the surface.

(4) Do not allow drops of water or chemicals to remain on the display surface.

If you have the droplets for a long time, staining and discoloration may occur.

(5) If the surface of the polarizer is dirty, clean it using some absorbent cotton or soft cloth.

(6) The desirable cleaners are water, IPA (Isopropyl Alcohol) or Hexane.

Do not use ketene type materials (ex. Acetone), Ethyl alcohol, Toluene, Ethyl acid or Methyl chloride. It might permanent damage to the polarizer due to chemical reaction.

(7) If the liquid crystal material leaks from the panel, it should be kept away from the eyes or mouth. In case of contact with hands, legs, or clothes, it must be washed away thoroughly with soap.

(8) Protect the module from static; it may cause damage to the CMOS ICs.

(9) Use finger-stalls with soft gloves in order to keep display clean during the incoming inspection and assembly process.

(10) Do not disassemble the module.

(11) Protection film for polarizer on the module shall be slowly peeled off just before use so that the electrostatic charge can be minimized.

(12) Pins of I/F connector shall not be touched directly with bare hands.

(13) Do not connect, disconnect the module in the "Power ON" condition.

(14) Power supply should always be turned on/off by the item 6.1 Power On Sequence & 6.2 Power Off Sequence

### 9.2 Storage and Transportation.

(1) Do not leave the panel in high temperature, and high humidity for a long time.

It is highly recommended to store the module with temperature from 0 to 35 °C and relative humidity of less than 70%

(2) Do not store the TFT-LCD module in direct sunlight.

(3) The module shall be stored in a dark place. When storing the modules for a long time, be sure to adopt effective measures for protecting the modules from strong ultraviolet radiation, sunlight, or fluorescent light.

(4) It is recommended that the modules should be stored under a condition where no condensation is allowed. Formation of dewdrops may cause an abnormal operation or a failure of the module.

In particular, the greatest possible care should be taken to prevent any module from being operated where condensation has occurred inside.

(5) This panel has its circuitry FPC on the bottom side and should be handled carefully in order not to be stressed.

Part. No	KD070HDFIA030-01	REV	V1.0	Page 26 of 27
常备库存 Stock For Sale	长期供货 Long Time supply	支持小量 NO MOQ	品种齐全 In Full Range	

## 10. Packing

---TBD-----

Part. No	KD070HDFIA030-01	REV	V1.0	Page 27 of 27
	常备库存 Stock For Sale	长期供货 Long Time supply	支持少量 NO MOQ	品种齐全 In Full Range