

# SPECIFICATION

## 产品规格书

NO.(编号) : RD vision

Part No.(型号) : 3030B03-XXV02-2P-D22

Description(描述) : 3030 White LED

Model(说明) : 3V 0.2W 紫光全光谱 双晶

CUSTOMER APPEROVED (客户审核)	APPROVED (核准)	ISSUED (制定)
	朱磊	吴亮亮

SHINEON (NANCHANG) TECHNOLOGY CO.,LTD

## 3030B03-XXV02-2P-D22 Datasheet

This 3030 LED Light Source is a high performance energy efficient device which can handle high thermal and high driving current. The small package outline and high intensity make it an ideal choice for LED panel light, LED bulb light, LED tube light, Education lighting and etc.

此款3030 LED光源是一款节能器件，具有良好的散热性、可以承受大电流使用。产品外形小巧，强度高，是LED面板灯、LED球泡灯、LED管灯、教育照明等产品的理想选择。

The White Power LED is available in the range of color temperature from 2600K to 7000K.

色温范围涵盖2600K至7000K。

This part has a foot print that is compatible to most of the same size LED in the market today.

此款LED光源焊盘结构与市场上主流LED光源焊盘尺寸基本相同。

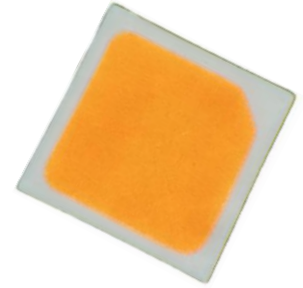

### FEATURES/特点

- Available in Cool White, Neutral White and Warm White color  
颜色包括冷白、中性白和暖白
- ANSI-compatible chromaticity bins  
符合美标ANSI色坐标分BIN标准
- High R9/ CRI; R9≥90, CRI ≥97  
高R9和显色指数
- High Rf /Rg  
高色彩逼真度和色彩饱和度
- Compatible with reflow soldering process  
匹配回流焊制程
- Low thermal resistance/低热阻
- Long operation life/长寿命
- Wide viewing angle at 120°  
发光角度 120°
- Silicone encapsulation/硅胶封装
- Environmental friendly, RoHS compliance  
环保材质，符合RoHS要求

### APPLICATIONS/应用

- Flat panel light/面板灯
- LED tube light/LED管灯
- Reading lamp/台灯
- Education lighting/教育照明

Note: The information in this document is subject to change without notice.

注:本文件内的资料如有更改，恕不另行通知。

PACKAGE DIMENSIONS 封装尺寸

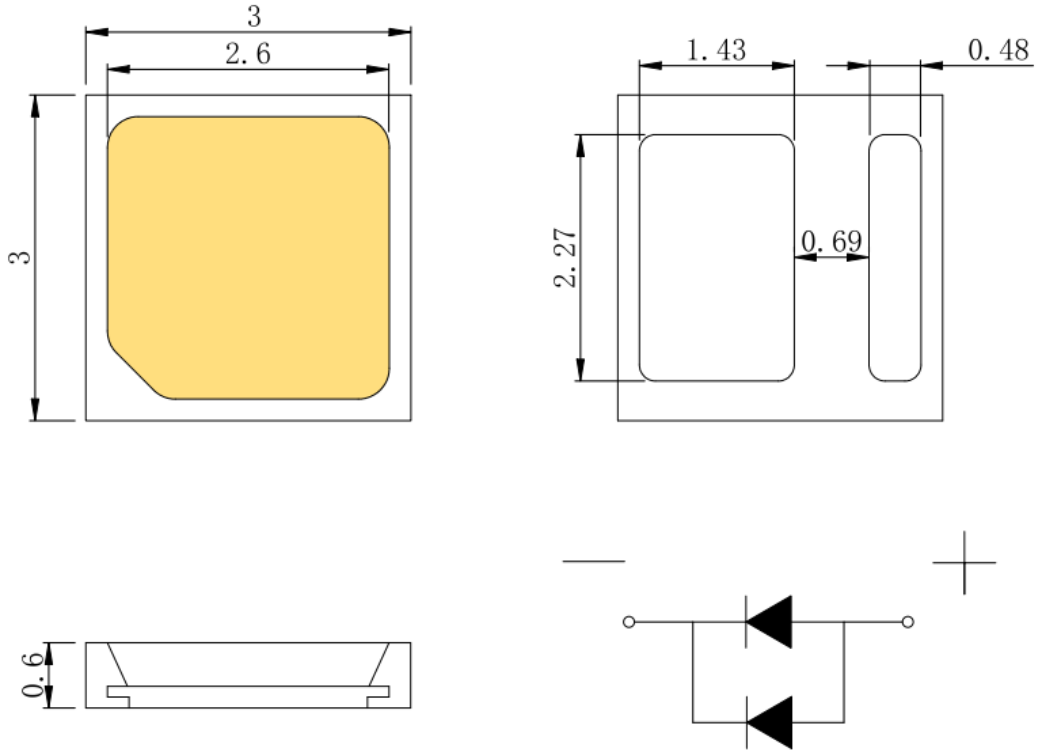

Recommended Solder Pad Design 推荐焊盘设计

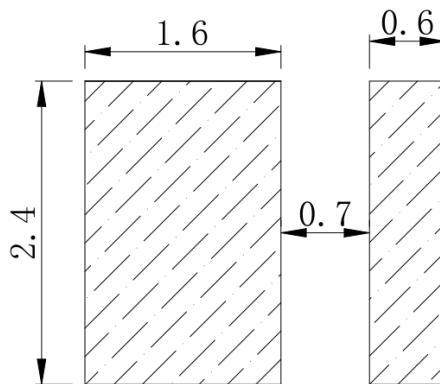

Notes/ 注:

1. All dimensions in millimeters. 所有尺寸单位为mm
2. Thickness tolerance of copper plate is  $\pm 0.02\text{mm}$ . 铜材料片厚度公差为 $\pm 0.02\text{mm}$
3. Thickness tolerance of product is  $\pm 0.05\text{mm}$ . 产品厚度公差为 $\pm 0.05\text{mm}$
4. Tolerance is  $\pm 0.1\text{mm}$  unless otherwise noted. 如未特别注明，默认公差为 $\pm 0.1\text{mm}$

**ABSOLUTE MAXIMUM RATINGS 最大限定参数 (Ta=25°C)**

Parameter 项目名称	Symbol 符号	Value 规格	Unit 单位
Forward current 正向电流	IF	150	mA
Peak Forward Current 正向脉冲电流	IFP	200	mA
Reverse Voltage 反向电压	VR	5	V
Power Dissipation 消耗功率	Pd	500	mW
Operating Temperature 工作温度	Topr	-40~+85	°C
Storage Temperature 储存温度	Tstg	-40~+100	°C
Soldering Temperature 焊接温度	Tsld	Reflow Soldering: 260°C for 10 seconds	
LED Junction Temperature 结温	Tj	125	°C

**ELECTRO-OPTICAL CHARACTERISTICS 主要光电参数(Ta=25°C)**

Parameter 项目名称	Symbol 符号	Test Condition 测试条件	Min 最小值	Typ 典型值	Max 最大值	Unit 单位
Forward Voltage 正向电压	V <sub>F</sub>	I <sub>F</sub> =65mA	2.8	2.9	3.1	V
Viewing Angle 发光角度	2θ <sub>1/2</sub>	I <sub>F</sub> =65mA	--	120	--	deg.
Luminous Flux 光通量	Φ <sub>v</sub>	I <sub>F</sub> =65mA	19	--	25	lm
Color Rendering Index 显色指数	CRI	I <sub>F</sub> =65mA	97	98	--	--
Color Fidelity Index 色彩逼真度指数	R <sub>f</sub>	I <sub>F</sub> =65mA	--	98	--	--
Color Gamut Index 色彩饱和度指数	R <sub>g</sub>	I <sub>F</sub> =65mA	--	100	--	--
Color Temperature 色温	CCT	I <sub>F</sub> =65mA	2600	--	7000	K
Thermal Resistance 热阻	R <sub>th-js</sub>	I <sub>F</sub> =65mA	--	10	--	°C/W

Notes 注:

- Luminous flux is measured with an accuracy of ± 5%. 光通量的测量精度为± 5%。
- Chromaticity coordinate bins are measured with an accuracy of ± 0.01. 色度坐标相对测量精度为± 0.01
- CRI is measured with an accuracy of ± 2. 显色指数测量精度为± 2
- Some color and CRI bins may have limited availability, please contact us before ordering.  
部分颜色和显指可能有限制, 请在订购前与我们联系
- All measurements were made under the standardized environment of Shineon  
所有的测量都是在易美的标准环境下进行的

**RELATIVE SPECTRAL POWER DISTRIBUTION 相对光谱功率分布 (T<sub>j</sub>=25°C)**

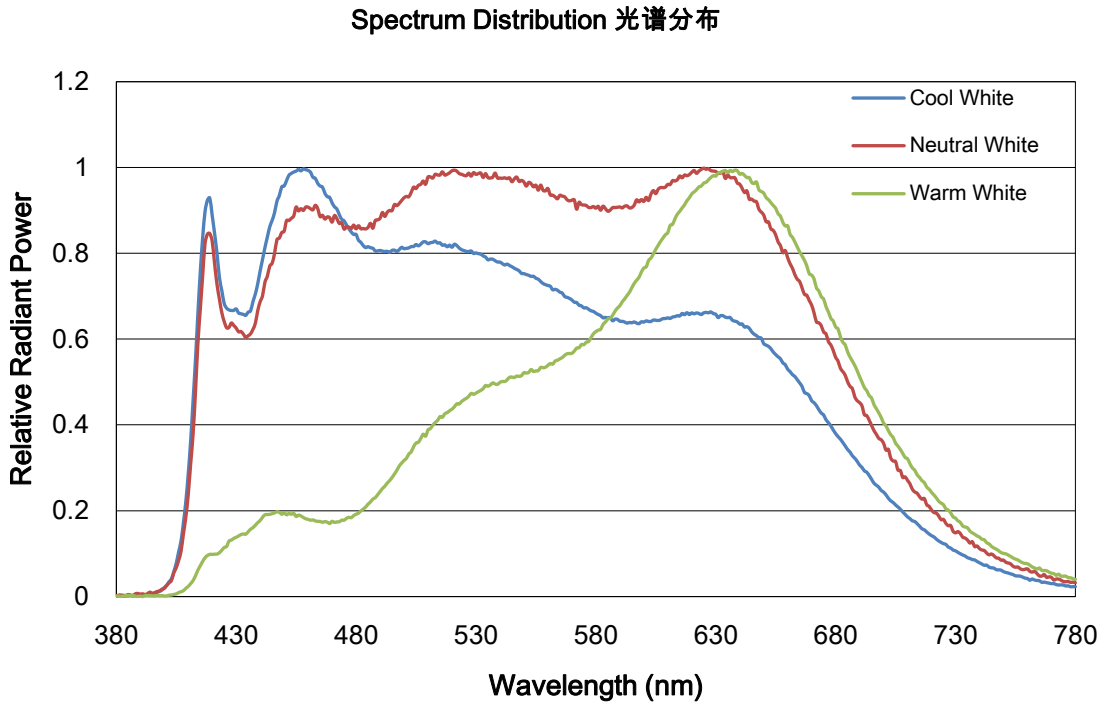

**TYPICAL SPATIAL DISTRIBUTION 典型配光分布**

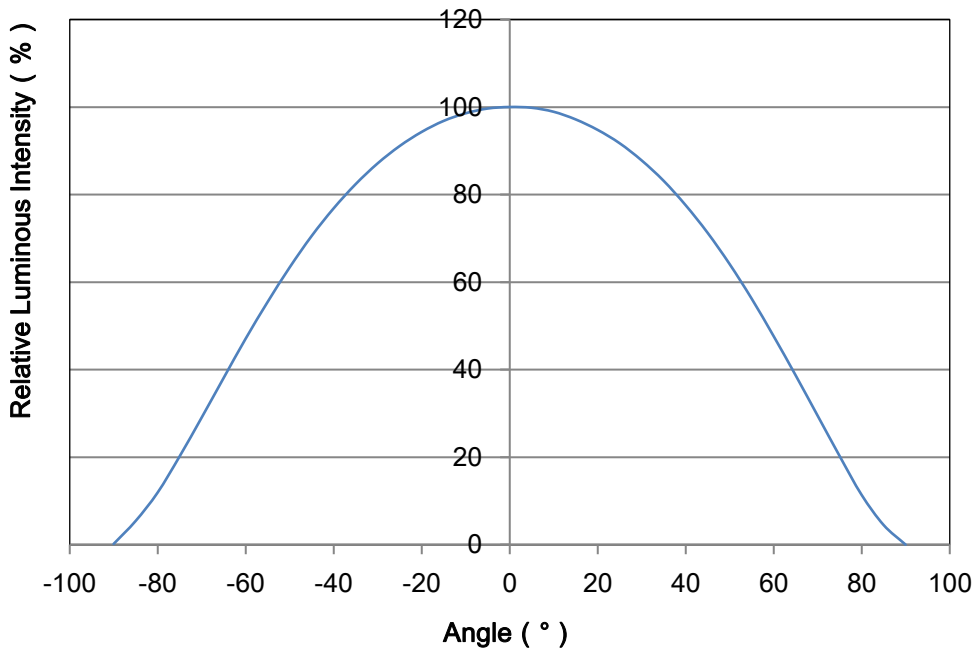

RELATIVE LUMINOUS FLUX VS. CURRENT 相对光通量VS电流 ( $T_j=25^\circ\text{C}$ )

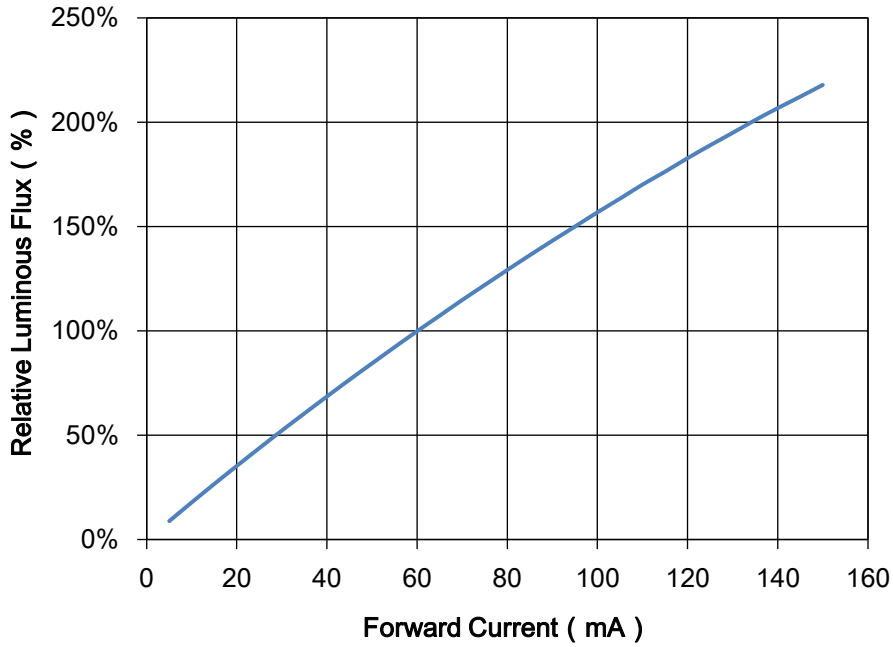

ELECTRICAL CHARACTERISTICS 电特性 ( $T_j=25^\circ\text{C}$ )

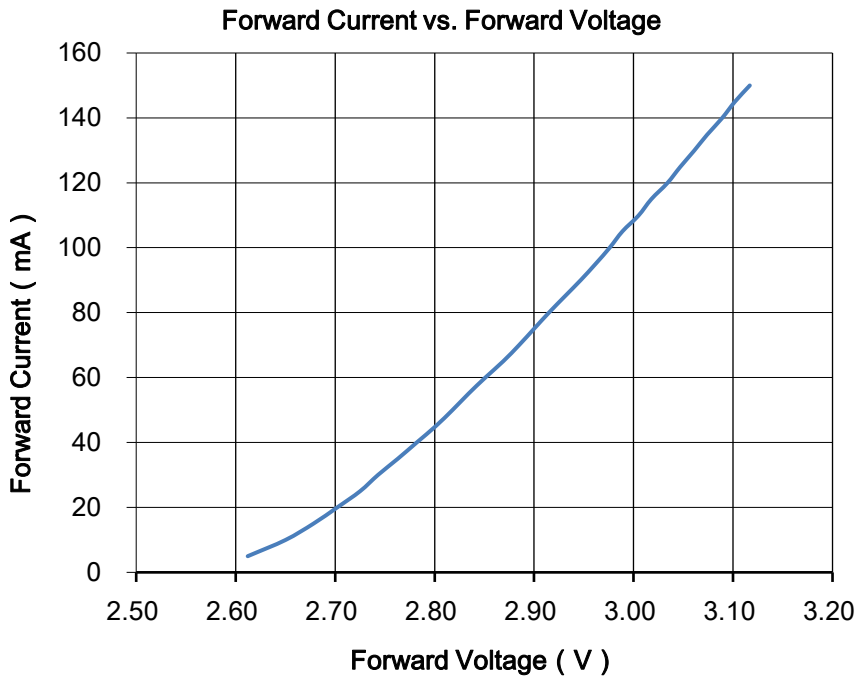

**MAXIMUM CURRENT VS. AMBIENT TEMPERATURE 最大电流VS环境温度**

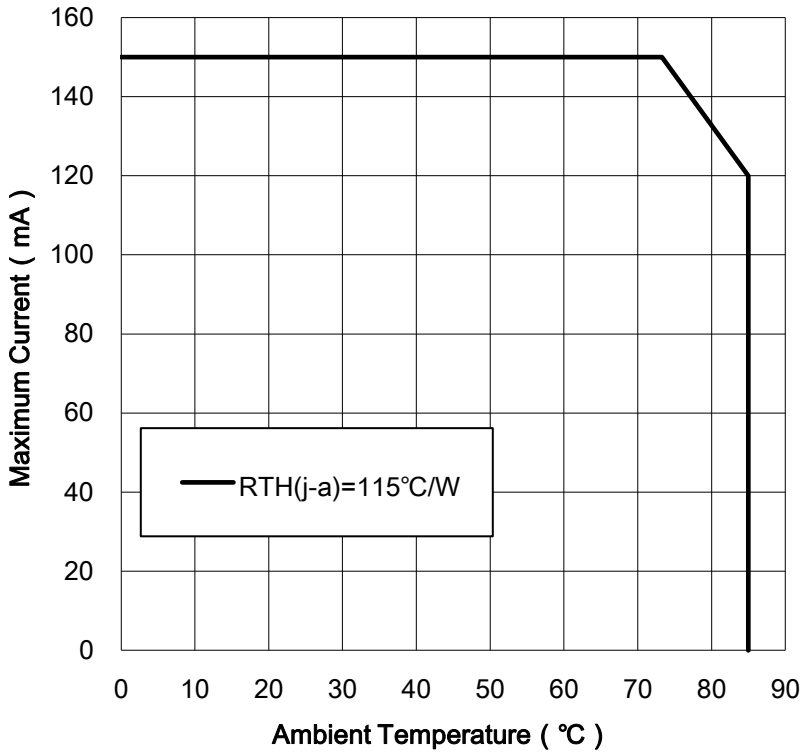

**RELATIVE RADIANT FLUX VS. JUNCTION TEMPERATURE 相对辐射通量VS结温**

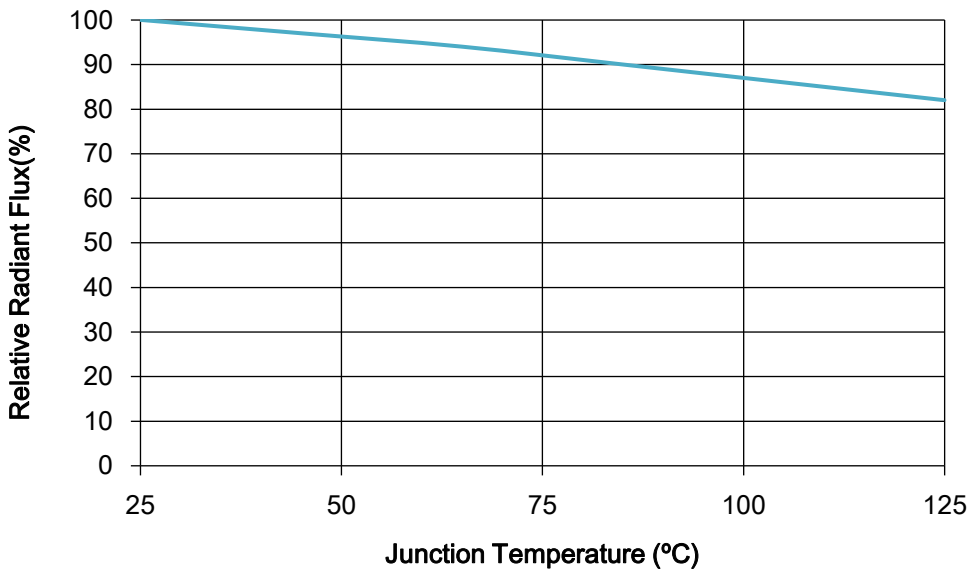

**SORTING RANKS 分光等级**
**(1) Luminous Flux 光通量 (Tj=25°C)**

Part Number 品名	Condition 条件	Rank 等级	Unit 单位
3030B03-27V02-2P-D22	65mA	M92	lm
		19-21	
3030B03-30V02-2P-D22		N12	
		21-23	
3030B03-32V02-2P-D22		N12	
		21-23	
3030B03-40V02-2P-D22		N34	
		23-25	
3030B03-50V02-2P-D22		N34	
		23-25	
3030B03-57V02-2P-D22		N34	
		23-25	
3030B03-65V02-2P-D22	N34		
	23-25		

**(2) Forward Voltage 正向电压(Tj=25°C)**

Rank 等级	Condition 条件	Min. 最小值	Max. 最大值	Unit 单位
A8	65mA	2.8	2.9	V
A9		2.9	3.0	
B0		3.0	3.1	

Notes 注：

- 5% tolerance for luminous intensity may be caused by measurement inaccuracy.  
光通量测量精度误差± 5%
- Measurement Uncertainty of the Forward Voltage : ± 3%  
正向电压测量误差:± 3%

(3) Chromaticity Bins 色坐标等级

Part Number 品名	3030B03-30V02-2P-D22			CCT 色温	3000K
Bin Code 等级代码	Color Coordinates 色坐标(x,y)				
E5	X	0.4427	0.4322	0.4254	0.4353
	y	0.4125	0.4088	0.3937	0.3973
E4	X	0.4509	0.4394	0.4338	0.4446
	y	0.4191	0.4150	0.4030	0.4069
E3	X	0.4446	0.4338	0.4282	0.4384
	y	0.4069	0.4030	0.3910	0.3944
E2	X	0.4338	0.4240	0.4189	0.4282
	y	0.4030	0.3995	0.3877	0.3910
E1	X	0.4394	0.4291	0.4240	0.4338
	y	0.4150	0.4113	0.3995	0.4030

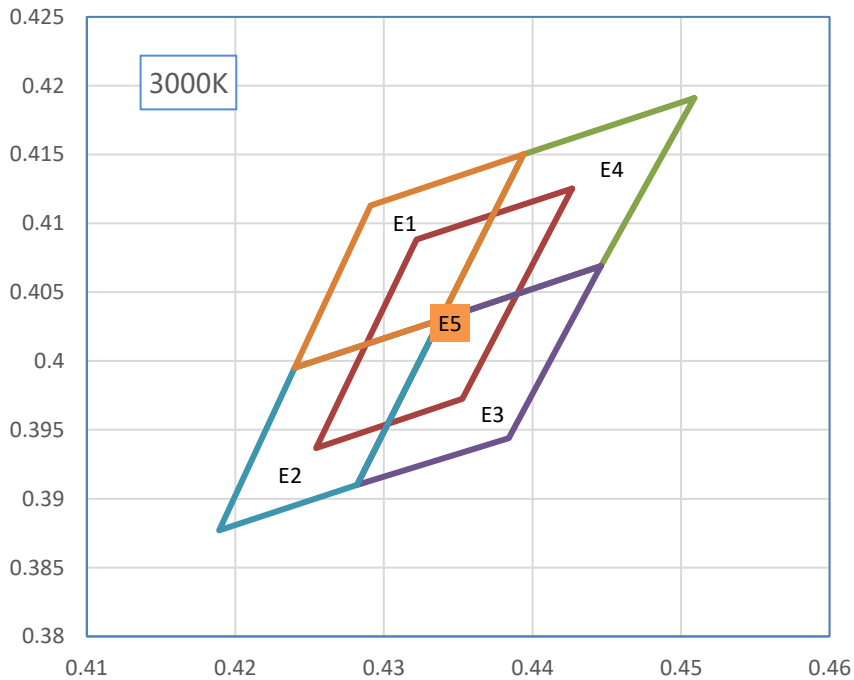

**(3) Chromaticity Bins 色坐标等级**

Part Number 品名	3030B03-32V02-2P-D22			CCT 色温	3200K
Bin Code 等级代码	Color Coordinates 色坐标(x,y)				
B5	X	0.4323	0.4218	0.4150	0.4249
	y	0.4080	0.4043	0.3892	0.3928
B4	X	0.4405	0.4290	0.4234	0.4342
	y	0.4146	0.4105	0.3985	0.4024
B3	X	0.4342	0.4234	0.4178	0.4280
	y	0.4024	0.3985	0.3865	0.3899
B2	X	0.4234	0.4136	0.4085	0.4178
	y	0.3985	0.3950	0.3832	0.3865
B1	X	0.4290	0.4187	0.4136	0.4234
	y	0.4105	0.4068	0.3950	0.3985

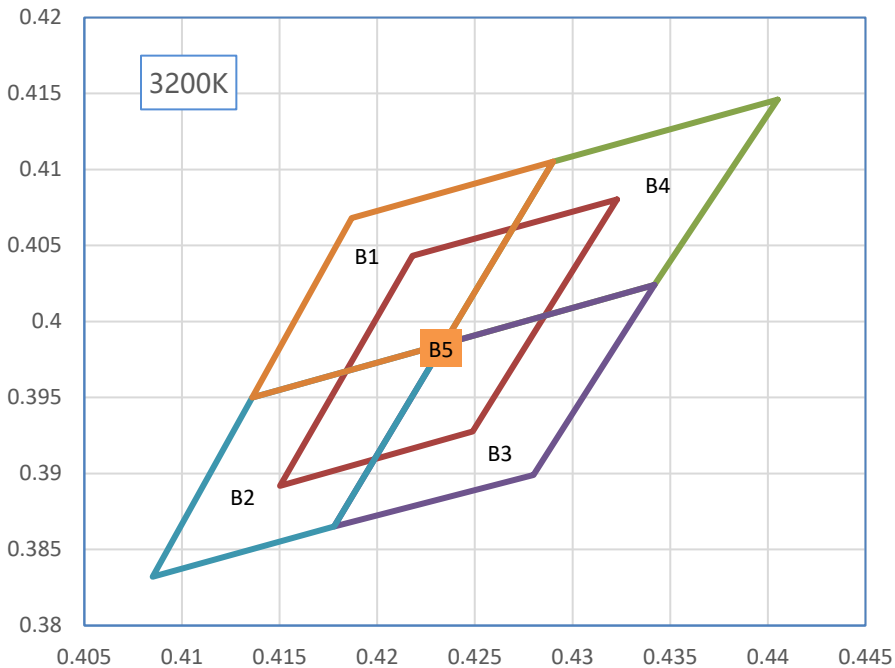

**(3) Chromaticity Bins 色坐标等级**

Part Number 品名	3030B03-40V02-2P-D22		CCT 色温	4000K	
Bin Code 等级代码	Color Coordinates 色坐标(x,y)				
G5	X	0.3900	0.3778	0.3744	0.3857
	y	0.3911	0.3835	0.3688	0.3759
G4	X	0.3971	0.3852	0.3818	0.3929
	y	0.4003	0.3928	0.3797	0.3867
G3	X	0.3929	0.3818	0.3784	0.3888
	y	0.3867	0.3797	0.3666	0.3731
G2	X	0.3818	0.3719	0.3692	0.3784
	y	0.3797	0.3735	0.3608	0.3666
G1	X	0.3852	0.3747	0.3719	0.3818
	y	0.3928	0.3862	0.3735	0.3797

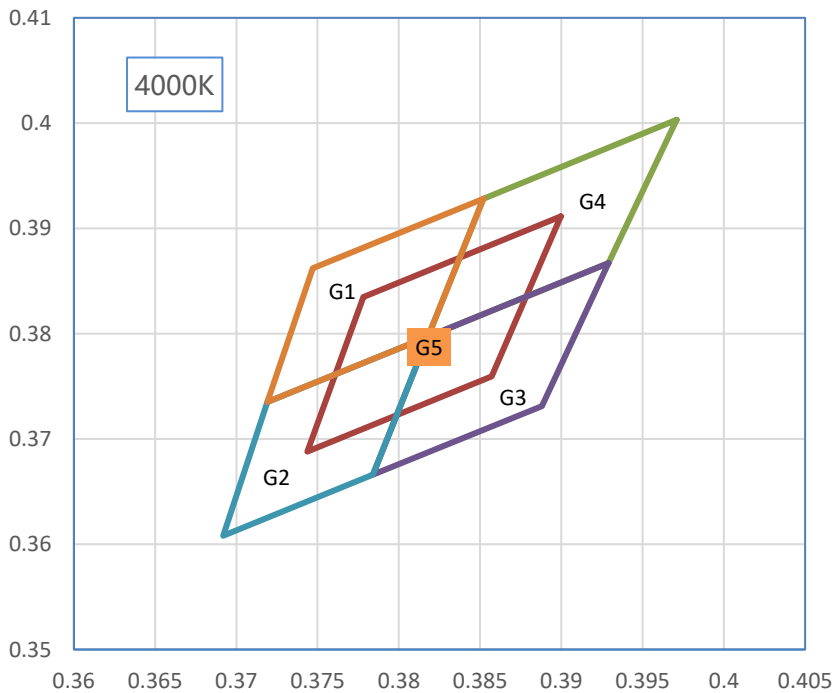

(3) Chromaticity Bins 色坐标等级

Part Number 品名	3030B03-50V02-2P-D22		CCT 色温	5000K	
Bin Code 等级代码	Color Coordinates 色坐标(x,y)				
H5	X	0.3507	0.3398	0.3393	0.3496
	y	0.3653	0.3564	0.3458	0.3543
H4	X	0.3546	0.3454	0.3447	0.3534
	y	0.3719	0.3643	0.3553	0.3625
H3	X	0.3534	0.3447	0.3440	0.3523
	y	0.3625	0.3553	0.3463	0.3531
H2	X	0.3447	0.3364	0.3361	0.3440
	y	0.3553	0.3485	0.3398	0.3463
H1	X	0.3454	0.3366	0.3364	0.3447
	y	0.3643	0.3571	0.3485	0.3553

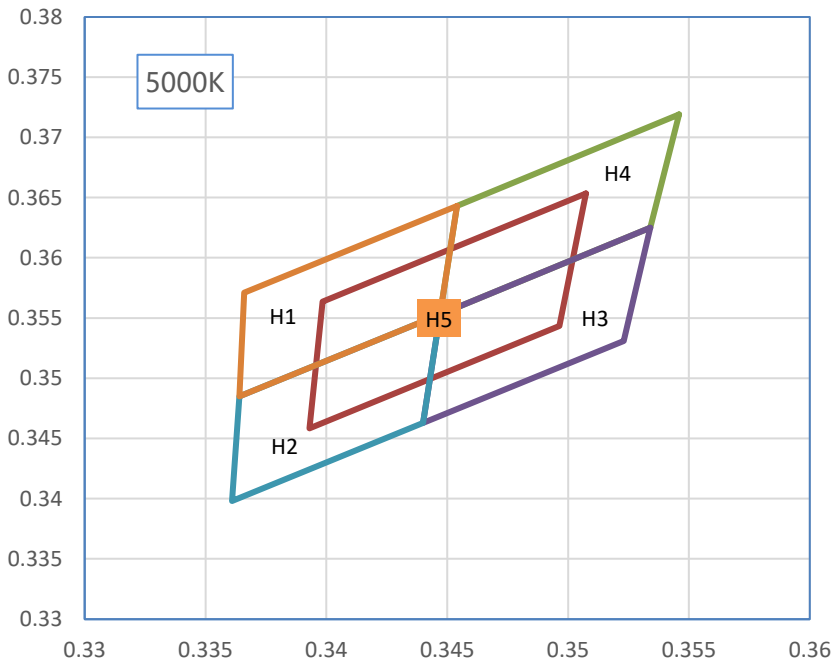

**(3) Chromaticity Bins 色坐标等级**

Part Number 品名	3030B03-57V02-2P-D22			CCT 色温	5700K
Bin Code 等级代码	Color Coordinates 色坐标(x,y)				
J5	X	0.3334	0.3240	0.3245	0.3333
	y	0.3506	0.3427	0.3332	0.3407
J4	X	0.3366	0.3285	0.3287	0.3364
	y	0.3561	0.3493	0.3417	0.3482
J3	X	0.3364	0.3287	0.3289	0.3361
	y	0.3482	0.3417	0.3341	0.3403
J2	X	0.3287	0.3219	0.3224	0.3289
	y	0.3417	0.3360	0.3286	0.3341
J1	X	0.3285	0.3214	0.3219	0.3287
	y	0.3493	0.3433	0.3360	0.3417

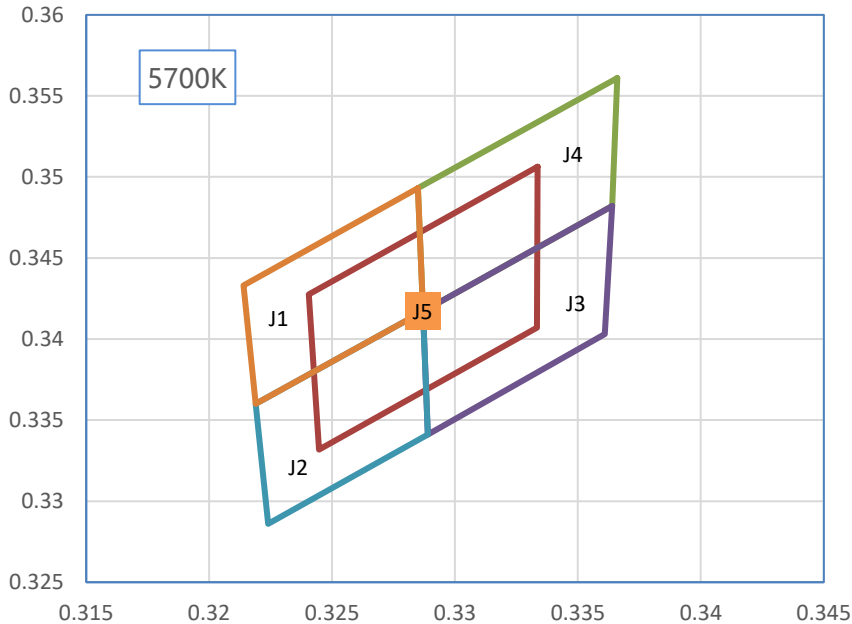

(3) Chromaticity Bins 色坐标等级

Part Number 品名	3030B03-65V02-2P-D22			CCT 色温	6500K
Bin Code 等级代码	Color Coordinates 色坐标(x,y)				
K5	X	0.3163	0.3075	0.3087	0.3172
	y	0.3364	0.3276	0.3201	0.3285
K4	X	0.3179	0.3113	0.3123	0.3187
	y	0.3420	0.3353	0.3282	0.3344
K3	X	0.3187	0.3123	0.3133	0.3193
	y	0.3344	0.3282	0.3207	0.3267
K2	X	0.3123	0.3067	0.3080	0.3133
	y	0.3282	0.3224	0.3153	0.3207
K1	X	0.3113	0.3054	0.3067	0.3123
	y	0.3353	0.3295	0.3224	0.3282

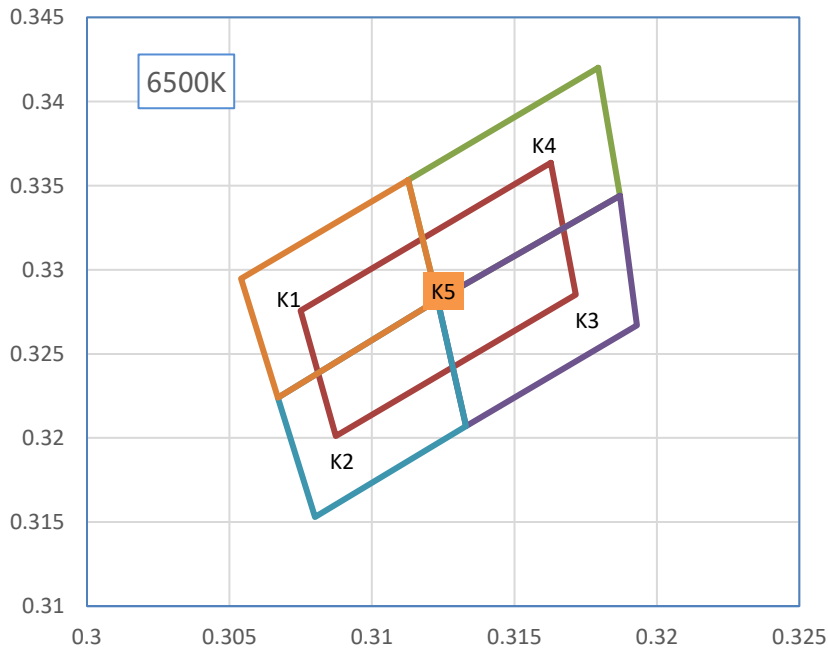

**(3) Chromaticity Bins 色坐标等级**

Part Number 品名	3030B03-50V02-2P-D22			CCT 色温	5000K
Bin Code 等级代码	Color Coordinates 色坐标(x,y)				
H5	X	0.3507	0.3398	0.3393	0.3496
	y	0.3653	0.3564	0.3458	0.3543
H4	X	0.3546	0.3454	0.3447	0.3534
	y	0.3719	0.3643	0.3553	0.3625
H3	X	0.3534	0.3447	0.3440	0.3523
	y	0.3625	0.3553	0.3463	0.3531
H2	X	0.3447	0.3364	0.3361	0.3440
	y	0.3553	0.3485	0.3398	0.3463
H1	X	0.3454	0.3366	0.3364	0.3447
	y	0.3643	0.3571	0.3485	0.3553



**REFLOW SOLDERING CHARACTERISTICS 回流焊特性**

**For Reflow Process 回流焊制程:**

Preheating 预热 : 140°C~160°C±5°C, within 2 minutes. 2分钟

Operation heating 作业加热 : 260°C(Max.) within 10 seconds.(Max)

260°C(最高) within 10 seconds.(最长)

Gradual Cooling (Avoid quenching). 逐渐冷却(避免淬火)

Lead solder 有铅焊接		Lead-free solder 无铅焊接	
Pre-heat 预热	120-150°C	Pre-heat 预热	150-200°C
Pre-heat time 预热实际那	120 sec.Max.	Pre-heat time 预热实际那	120 sec.Max.
Peak Temperature 峰值温度	240°C Max.	Peak Temperature 峰值温度	260°C Max.
Soldering time condition 回流焊时间	10 sec.Max.	Soldering time condition 回流焊时间	10 sec.Max.

 <p><b>Lead Solder</b></p> <p>2.5-5 °C / sec. (initial ramp)</p> <p>2.5-5 °C / sec. (pre-heat ramp)</p> <p>Pre-heating 120~150 °C (120sec. Max.)</p> <p>240 °C Max. (10 sec. Max.)</p> <p>60sec. Max. Above 200 °C</p>	 <p><b>Lead-free Solder</b></p> <p>1-5 °C / sec. (initial ramp)</p> <p>1-5 °C / sec. (pre-heat ramp)</p> <p>Pre-heating 150~200 °C (120sec. Max.)</p> <p>260 °C Max. (10 sec. Max.)</p> <p>60sec. Max. Above 220 °C</p>
---	--

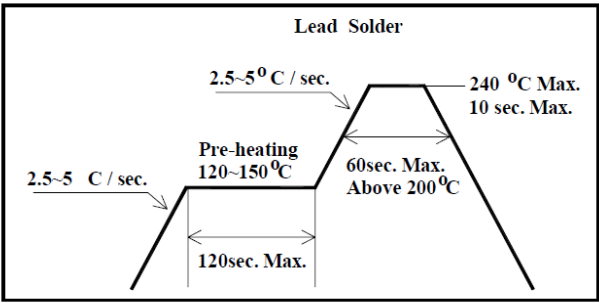
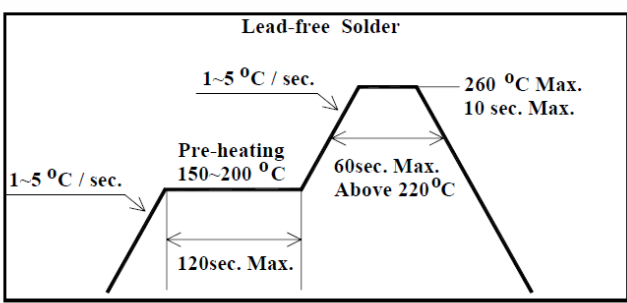
Notes 注:

The encapsulated material of the LEDs is silicone . Therefore the LEDs have a soft surface on the top of package. The pressure to the top surface will be influence to the reliability of the LEDs. Precautions should be taken to avoid the strong pressure on the encapsulated part. So when using the picking up nozzle, the pressure on the silicone resin should be proper.

由于LED的封装材料是硅胶，led封装顶部表面是柔软的，顶部表面的压力会影响led的可靠性。应采取预防措施，以避免密封部件受到强大的压力。因此，在使用吸嘴时，应使硅胶表面的压力适中。

TAPE AND REEL 编带

symbol	AO	BO	KO	PO	P1	P2
Spec	3.30±0.10	3.30±0.10	1.05±0.1	4.00±0.10	4.00±0.10	2.0±0.1
symbol	W	T	E	F	DO	D1
Spec	8.0±0.2	0.20±0.05	1.75±0.10	3.5±0.05	1.50+0.1/-0	1.1±0.1

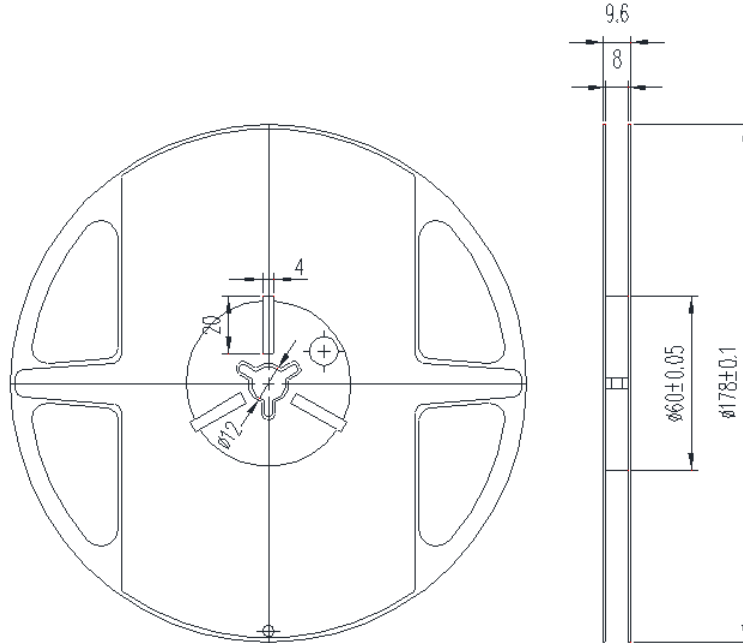
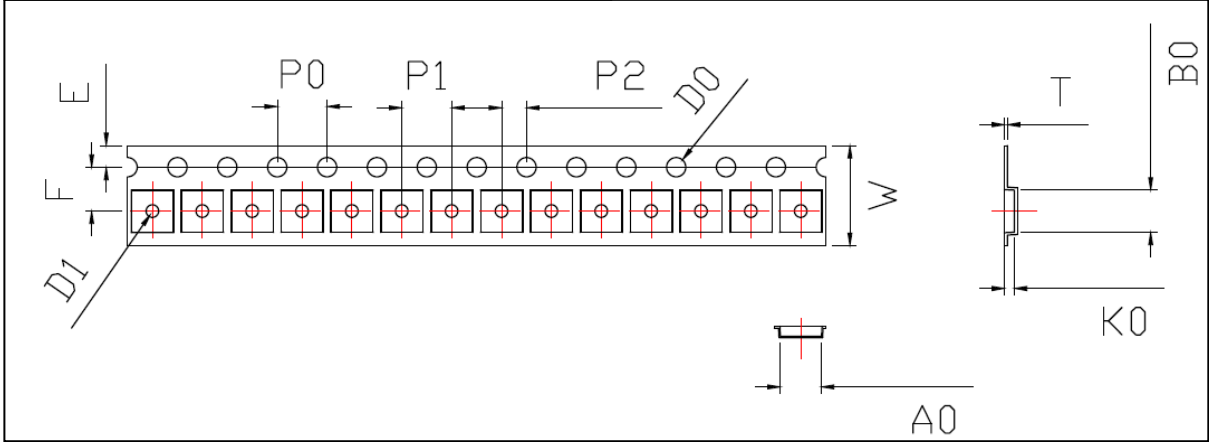

Note: The tolerances unless mentioned is ±0.1mm, Unit=mm

Notes注:

- (1) Quantity : 4,000pcs/Reel  
数量 : 4000pcs/卷
- (2) Cumulative Tolerance : Cumulative Tolerance/10 pitches to be ±0.2mm  
累积公差:累积公差/10间距 ±0.2毫米
- (3) Adhesion Strength of Cover Tape : Adhesion strength to be 0.1-0.7N when the cover tape is turned off from the carrier tape at the angle of 10° to the carrier tape  
盖带粘附强度:盖带反向拉, 与载带角度为10°, 拉力为0.1-0.7N
- (4) Package : P/N, Manufacturing data Code No. and quantity to be indicated on a damp proof Package.  
包装 : 品名, 生产数据代码和数量须在防潮包装上注明

**PACKAGING 包装**



REEL  
卷盘

Label

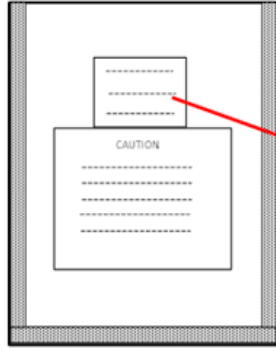

moisture-proof bag  
防潮袋

Label

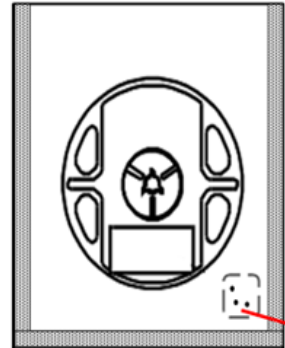

desiccant

干燥包

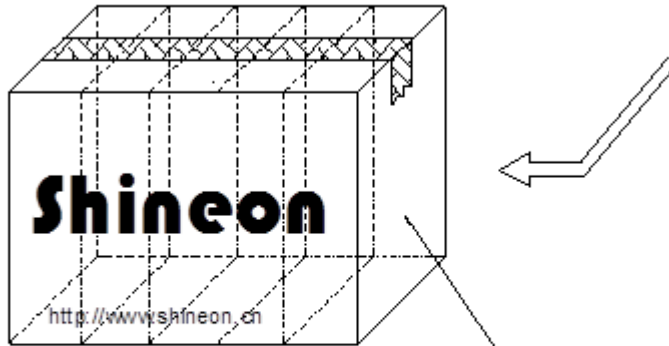

Outside box  
Maximums 48 Reels

外箱  
最多48卷盘

**Reliability Test Items 可靠性测试项目**

Test Items 测试项目	Test Duration 测试时长	Number of Damaged 不良数
Steady State Operating Life of High Temperature (HTOL) $T_s=85^{\circ}\text{C}$ , $I_F=\text{Max}$ 高温点亮稳态老化 $T_s=85^{\circ}\text{C}$ , $I_F=\text{最大值}$	1000hrs	0/20
Steady State Operating Life of Low Temperature (LTOL) $T_a=-40^{\circ}\text{C}$ , $I_F=\text{Max}$ 低温点亮稳态老化 $T_s=85^{\circ}\text{C}$ , $I_F=\text{最大值}$	1000hrs	0/20
High Temperature Storage (HTS) 高温存储 $100^{\circ}\text{C}$	1000hrs	0/20
Low Temperature Storage (LTS) 低温存储 $-40^{\circ}\text{C}$	1000hrs	0/20
Thermal Shock (TS) $-45^{\circ}\text{C}\sim 125^{\circ}\text{C}$ 15min dwell 30sec transfer 冷热冲击 $-45^{\circ}\text{C}$ 15min $\sim 125^{\circ}\text{C}$ 15min, 转换时间30秒	100cycles	0/20
Solder Resistance (SR) $265^{\circ}\text{C}$ , 3X MSL 阻焊测试 (3遍潮气敏感度试验后)	5sec	0/20
Solder Ability (SA) $245^{\circ}\text{C}$ 5sec, 95% coverage 可焊性 95%覆盖	5sec	0/11

Item 项目	Symbol 符号	Test Condition 测试条件	Criteria for Judgment 判定标准	
			Min. 最小	Max. 最大
Forward Voltage 正向电压	$V_f$	$I_F=\text{Typical Current}$ 典型电流		U.S.L x1.1
Luminous Flux 光通量	$I_m$	$I_F=\text{Typical Current}$ 典型电流	L.S.L x0.7	
CCX&CCY X坐标&Y坐标	x,y	$I_F=\text{Typical Current}$ 典型电流		Shift<0.02 漂移<0.02

## PRECAUTION FOR USE 使用注意事项

---

(1) This device should not be used in any type of fluid such as water, oil, organic solvent, etc. When washing is required, IPA should be used.

本器件不得置于水、油、有机溶剂等任何流体中。如需清洁，请使用异丙醇进行清洗。

(2) When the LEDs are illuminating, operating current should be decided after considering the ambient maximum temperature.

当LED发光工作时，应根据环境最高温度来确定工作电流。

(3) LEDs must be stored to maintain a clean atmosphere. If the LEDs are stored for 3 months or more after being shipped from ShineOn, a sealed container with a nitrogen atmosphere should be used for storage.

LED储存环境须保持清洁。如果LED从易美发货后需储存3个月或更长时间，则应使用氮气柜进行储存。

(4) The LEDs must be used within seven days after opening the moisture proof packing.

Repack unused Products with anti-moisture packing, fold to close any opening and then store in a dry place.

LED须在打开防潮包装后七天内使用。用防潮包装重新包装未使用的产品，折叠以封住开口，然后存放在干燥的地方。

(5) The appearance and specifications of the product may be modified for improvement without notice.

产品外观及规格如有改进，恕不另行通知。

(6) This LED is sensitive to the static electricity and surge. It is recommended to use a wrist Band or anti-electrostatic glove when handling the LEDs.

LED对静电和浪涌很敏感。在处理LED时，建议使用防静电腕带或防静电手套。

(7) On manual soldering, a solder tip must be needed as grounded for usage. If over voltage which exceeds the absolute maximum rating is applied to LEDs, it will cause damage LEDs and result in destruction. Damaged LEDs will show some unusual characteristics such as leak current remarkably increase, turn-on voltage becomes lower and the LEDs get unlighted at low current.

手工焊接时，焊接仪器必须接地。如果对led施加超过绝对最大额定值的过电压，会对led造成损坏。损坏的led会出现一些不寻常的特性，如漏电流明显增加，接通电压降低，低电流时led不亮。