

2835A02-660R05-K2P-R2 Datasheet

This 2835 LED Light Source is a high performance energy efficient device which can handle high thermal and high driving current. The small package outline and high intensity make it an ideal choice for LED panel light, LED bulb light, LED tube light and etc.

This part has a foot print that is compatible to most of the same size LED in the market today.



FEATURES

- High luminous Intensity and high efficiency
- Compatible with reflow soldering process
- Low thermal resistance
- Long operation life
- Wide viewing angle at 120°
- Silicone encapsulation
- Environmental friendly, RoHS compliance

APPLICATIONS

- Horticulture

Note: The information in this document is subject to change without notice.

PACKAGE DIMENSIONS

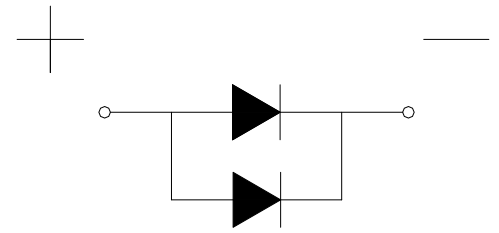
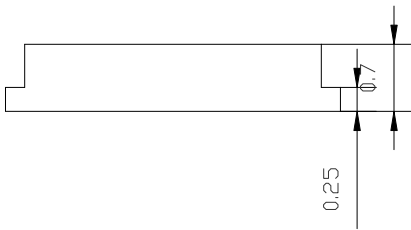
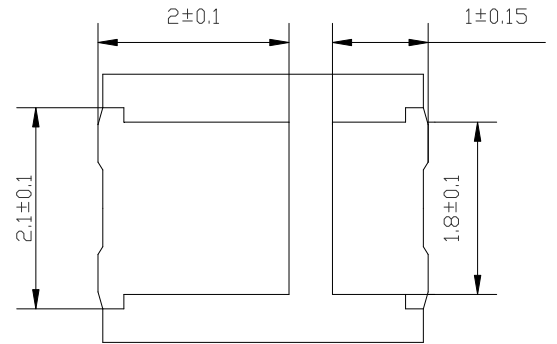
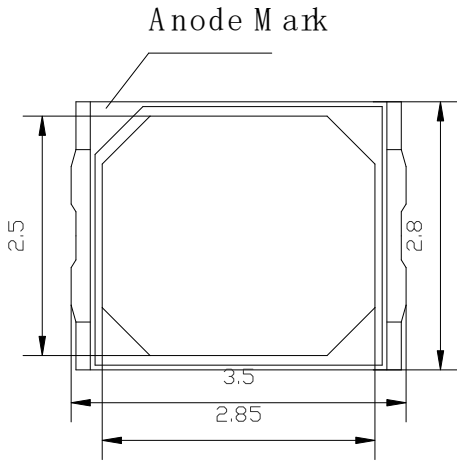

Recommended Solder Pad Design

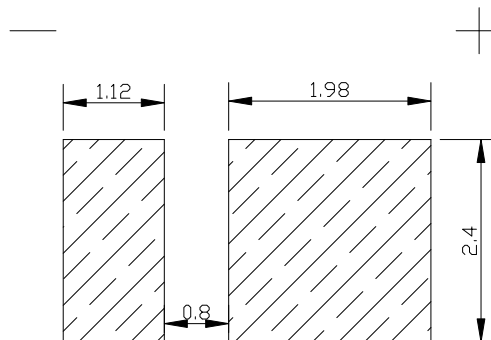

Notes:

1. All dimensions in millimeters.
2. Thickness tolerance of copper plate is ± 0.02 mm.
3. Thickness tolerance of product is ± 0.05 mm.
4. Tolerance is ± 0.1 mm unless otherwise noted.

ABSOLUTE MAXIMUM RATINGS

Item	Symbol	Absolute Maximum Rating	Unit
Forward current	I_F	160	mA
Peak Forward Current ^[1]	I_{FP}	400	mA
Reverse Voltage	V_R	5	V
Power Dissipation	P_d	416	mW
Operating Temperature	T_{opr}	-40~+85	°C
Storage Temperature	T_{stg}	-40~+100	°C
Soldering Temperature	T_{sld}	Reflow Soldering: 260°C for 10 seconds	
LED Junction Temperature	T_j	115	°C

Note:

I_{FP} Conditions: Pulse Width \leq 10msec. and Duty \leq 1/10.

CHARACTERISTICS (T_j=25°C)

Parameter	Symbol	Condition	Min	Typ	Max	Unit
Forward Voltage ^[1]	V_F	$I_F=150mA$	2.0	--	2.6	V
Viewing Angle	$2\theta_{1/2}$	$I_F=150mA$	--	120	--	deg.
Radiometric Power	Φ_e	$I_F=150mA$	130	--	160	mW
Peak Wavelength	λ_p	$I_F=150mA$	655	--	665	nm
Photon Flux	PPF	$I_F=150mA$	--	0.64	--	umol/s
Photon Flux Efficiency	PPE	$I_F=150mA$	--	2.13	--	umol/J
Thermal Resistance (Junction to Solder Point)	R_{th-js}	$I_F=150mA$	--	40	--	°C/W

Notes:

Notes/注:

1. Radiometric Power is measured with an accuracy of $\pm 5\%$. 辐射功率的测量精度为 $\pm 5\%$ 。
2. peak wavelength is measured with an accuracy of $\pm 1nm$. 峰值波长的测量精度为 $\pm 1nm$ 。
3. All measurements were made under the standardized environment of Shineon
所有的测量都是在易美的标准环境下进行的

RELATIVE SPECTRAL POWER DISTRIBUTION ($T_j=25^\circ\text{C}$)

Spectrum Distribution

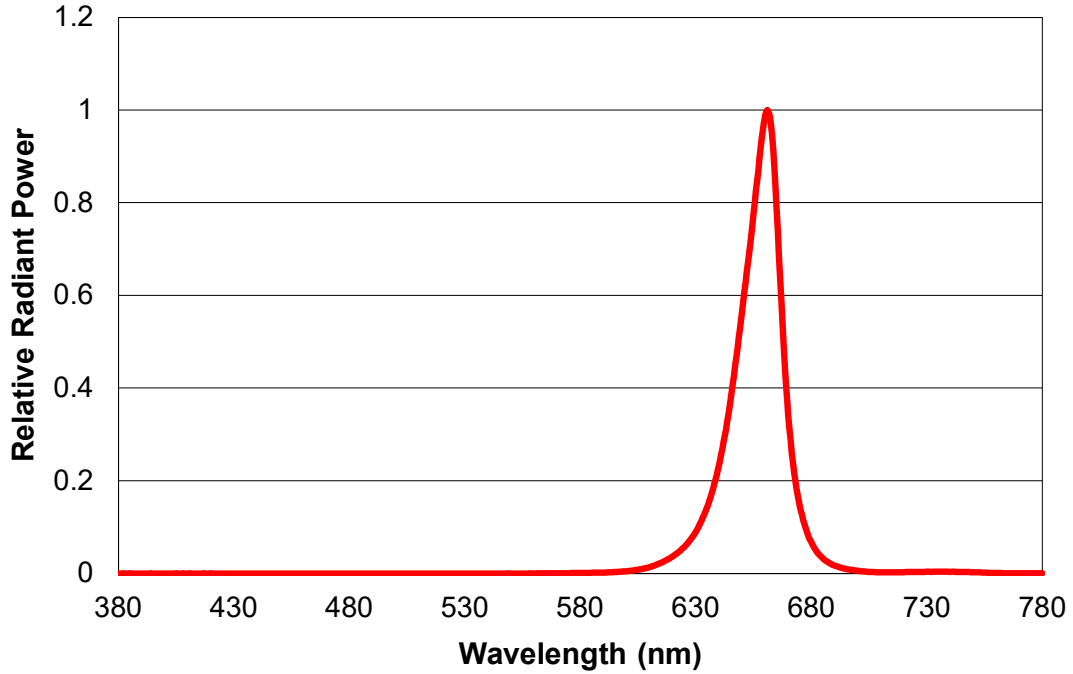

TYPICAL SPATIAL DISTRIBUTION

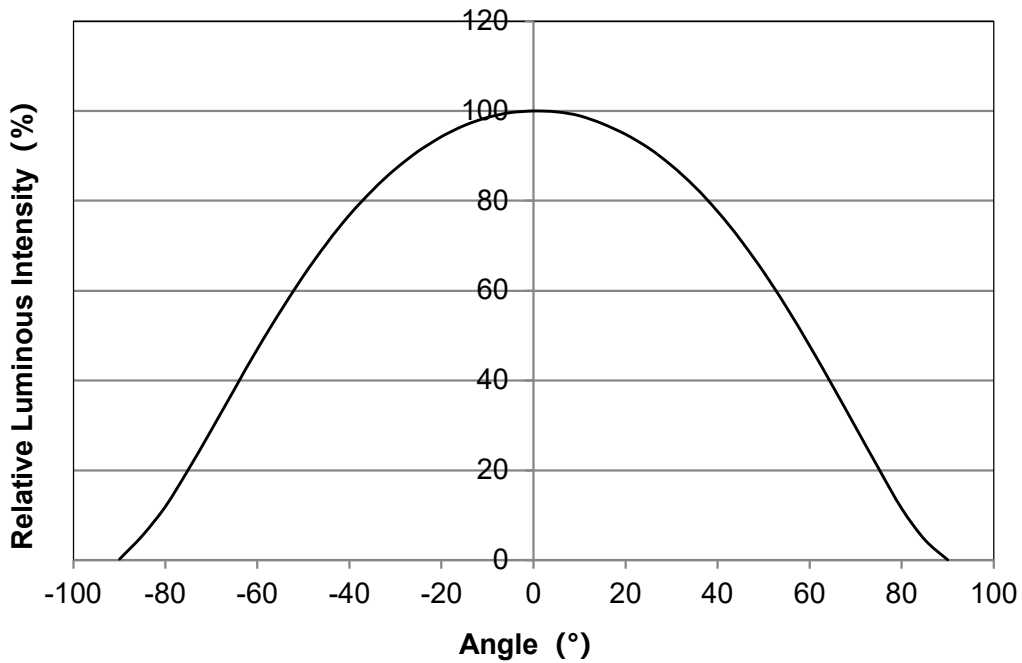

PPE VS. CURRENT ($T_j=25^\circ\text{C}$)

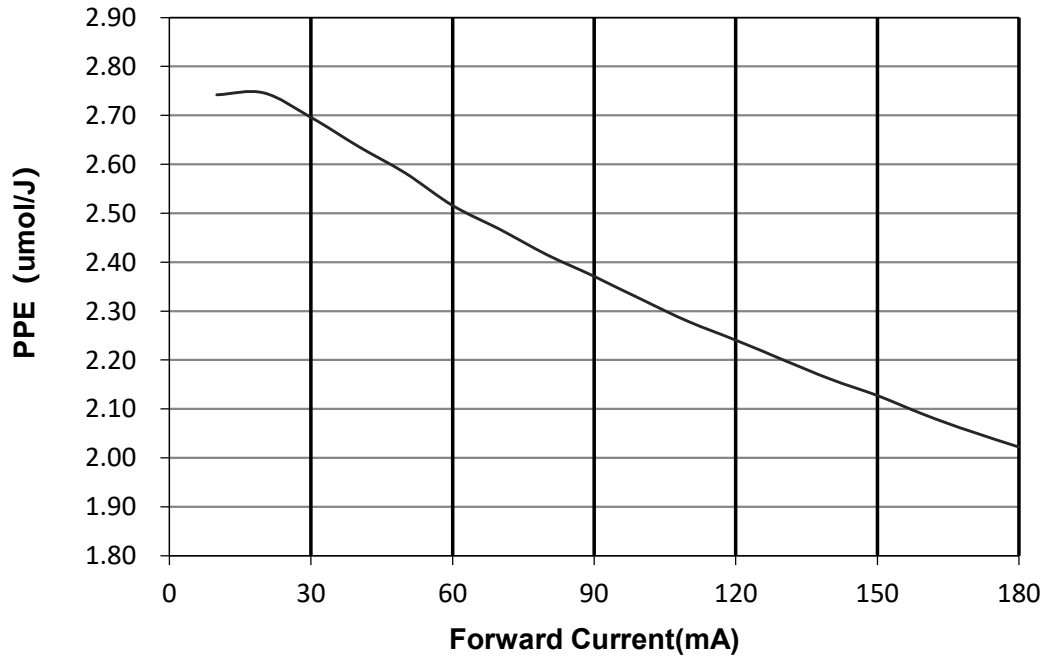

ELECTRICAL CHARACTERISTICS ($T_j=25^\circ\text{C}$)

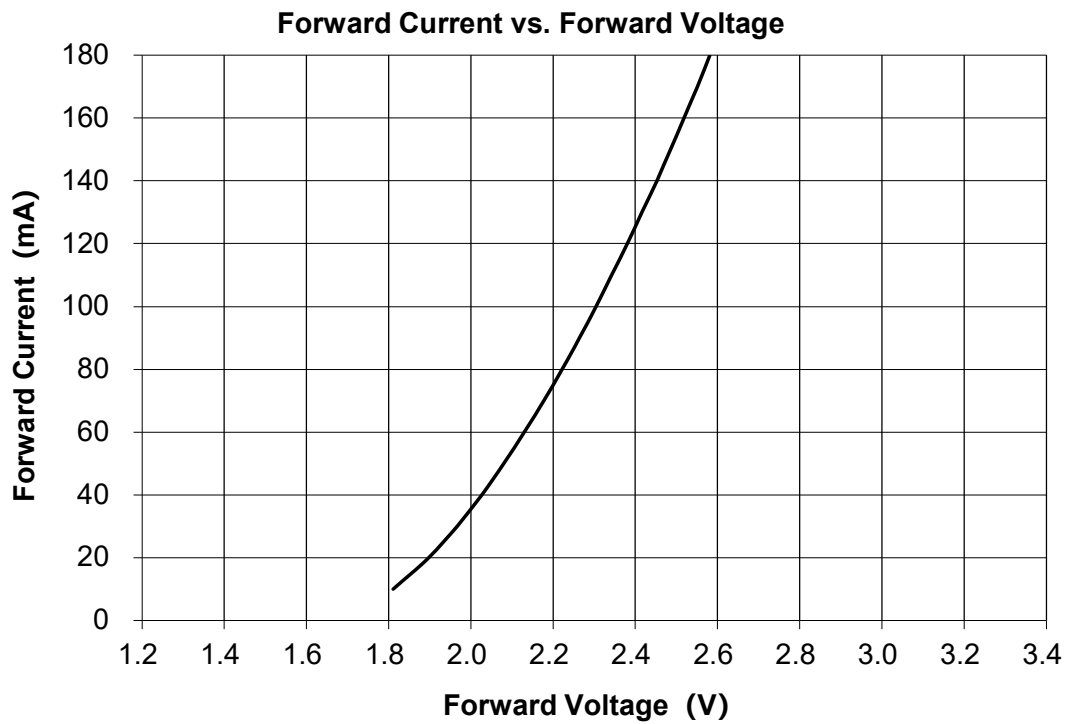

MAXIMUM CURRENT VS. AMBIENT TEMPERATURE

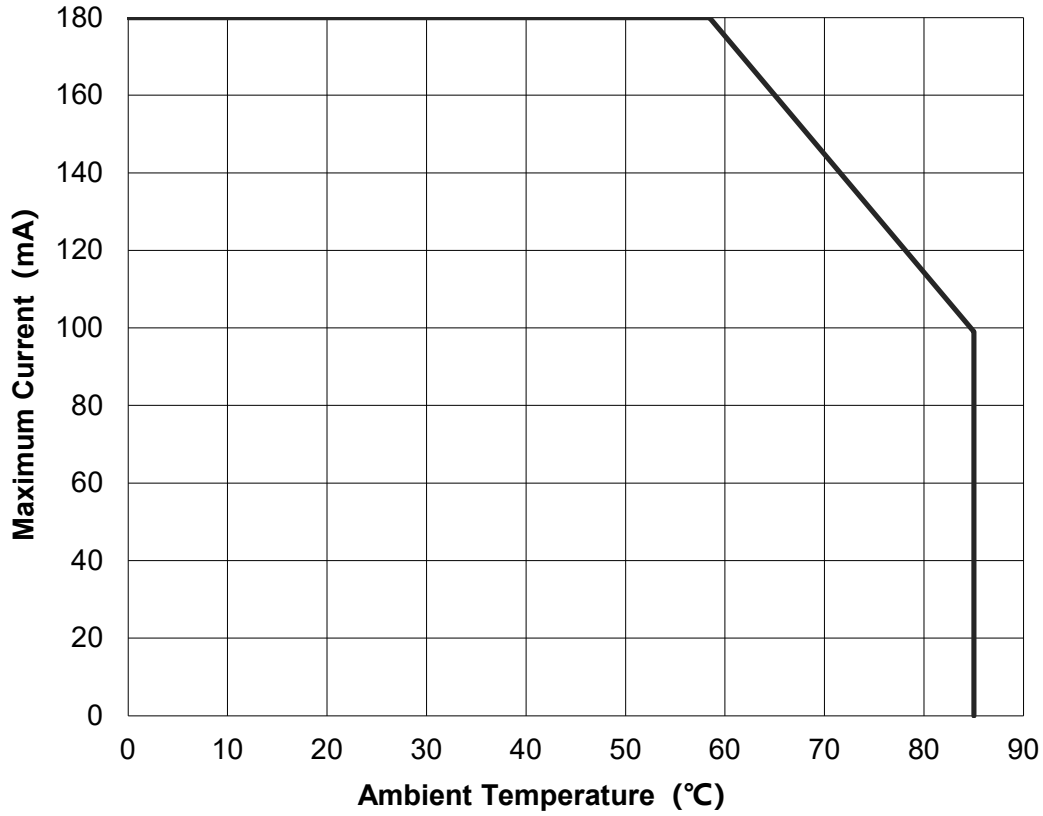

RELATIVE RADIANT FLUX VS. JUNCTION TEMPERATURE

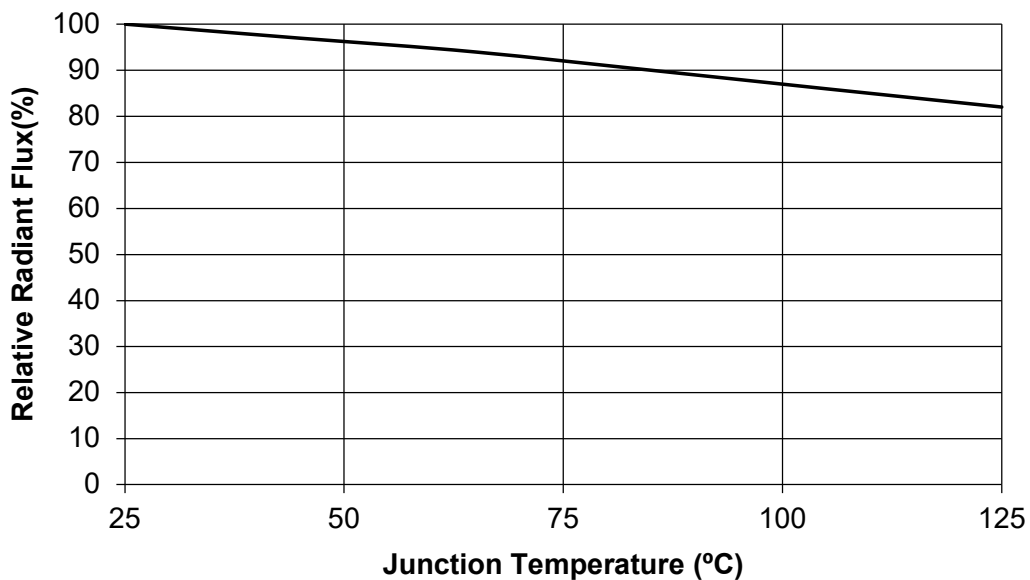

SORTING RANKS
(1) Radiometric Power (Tj=25°C)

Part Number	Condition	Rank			Unit
		Q3	Q4	Q5	
2835A02-660R05-K2P-R2	150mA	130-140	140-150	150-160	mW

(2) Forward Voltage (Tj=25°C)

Rank	Condition	Min.	Max.	Unit
AA	150mA	2.0	2.2	V
AB		2.2	2.4	
AC		2.4	2.6	

Notes:

1. 10% tolerance for luminous intensity may be caused by measurement inaccuracy.
2. Measurement Uncertainty of the Forward Voltage : $\pm 0.1V$

REFLOW SOLDERING CHARACTERISTICS

For Reflow Process:

Preheating : 140°C~160°C±5°C, within 2 minutes.
 Operation heating : 260°C(Max.) within 10 seconds.(Max)
 Gradual Cooling (Avoid quenching).

Lead solder		Lead-free solder	
Pre-heat	120-150°C	Pre-heat	150-200°C
Pre-heat time	120 sec.Max.	Pre-heat time	120 sec.Max.
Peak Temperature	240°C Max.	Peak Temperature	260°C Max.
Soldering time condition	10 sec.Max.	Soldering time condition	10 sec.Max.

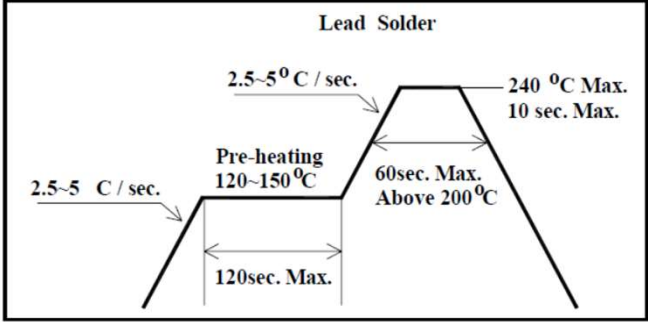
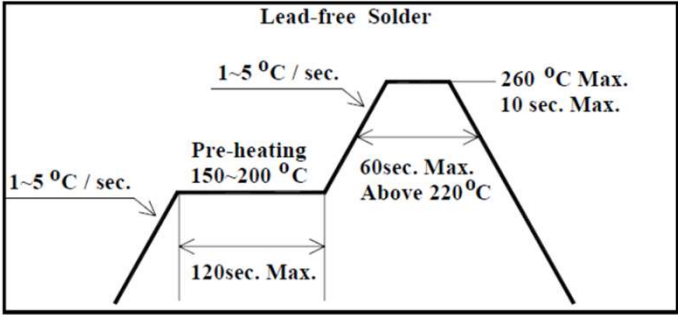
 <p>Lead Solder</p> <p>2.5~5 °C / sec. (initial ramp) 2.5~5 °C / sec. (pre-heat ramp) Pre-heating 120~150 °C (120sec. Max.) 240 °C Max. (10 sec. Max.) 60sec. Max. Above 200 °C</p>	 <p>Lead-free Solder</p> <p>1~5 °C / sec. (initial ramp) 1~5 °C / sec. (pre-heat ramp) Pre-heating 150~200 °C (120sec. Max.) 260 °C Max. (10 sec. Max.) 60sec. Max. Above 220 °C</p>
---	--

Notes:

The encapsulated material of the LEDs is silicone . Therefore the LEDs have a soft surface on the top of package. The pressure to the top surface will be influence to the reliability of the LEDs. Precautions should be taken to avoid the strong pressure on the encapsulated part. So when using the picking up nozzle, the pressure on the silicone resin should be proper.

TAPE AND REEL

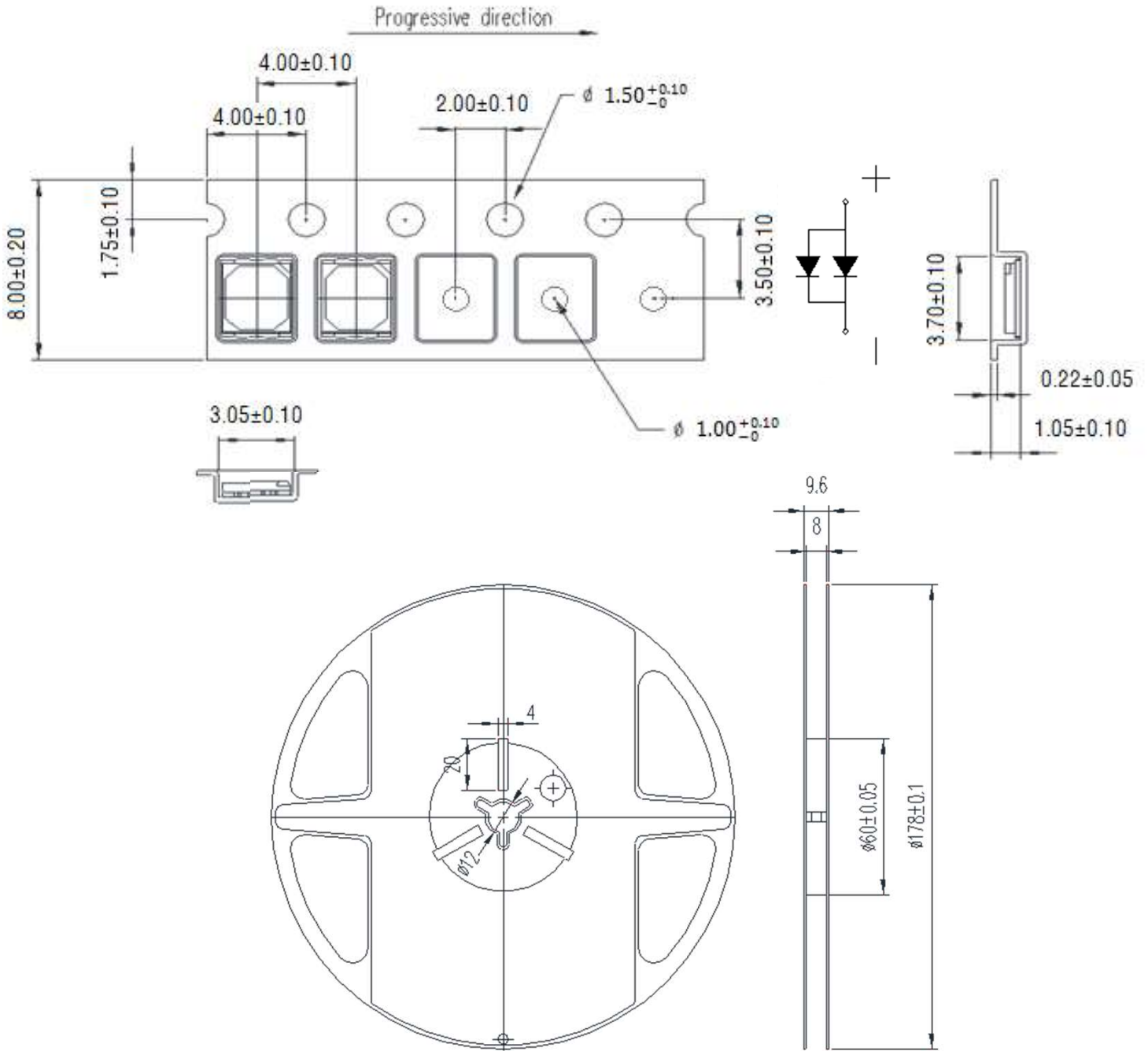

Note: The tolerances unless mentioned is $\pm 0.1\text{mm}$, Unit=mm

Notes:

- (1) Quantity : 3,500pcs/Reel
- (2) Cumulative Tolerance : Cumulative Tolerance/10 pitches to be $\pm 0.2\text{mm}$
- (3) Adhesion Strength of Cover Tape : Adhesion strength to be 0.1-0.7N when the cover tape is turned off from the carrier tape at the angle of 10° to the carrier tape
- (4) Package : P/N, Manufacturing data Code No. and quantity to be indicated on a damp proof Package.

PACKAGING

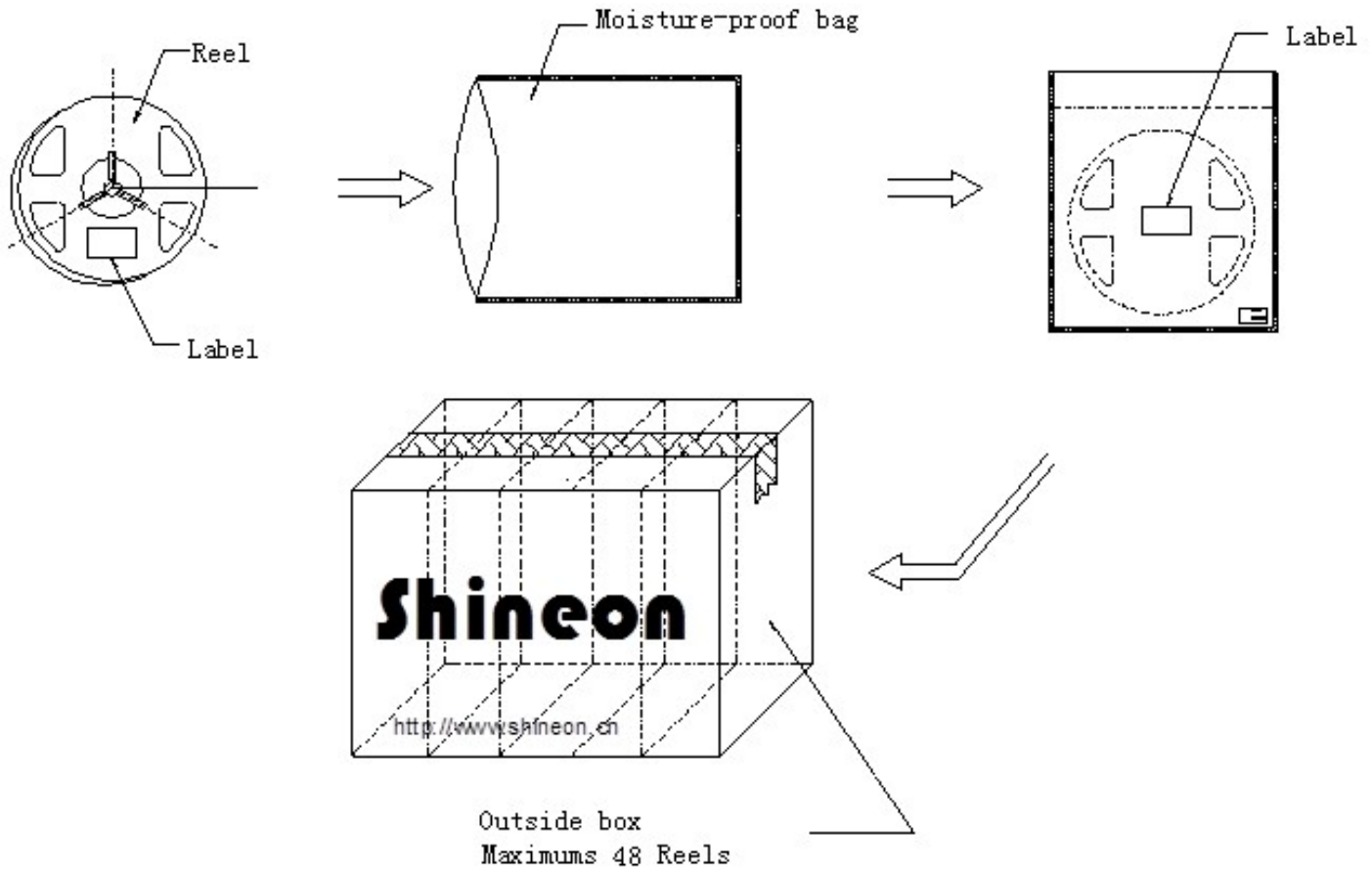

PRECAUTION FOR USE

- (1) This device should not be used in any type of fluid such as water, oil, organic solvent, etc. When washing is required, IPA should be used.
- (2) When the LEDs are illuminating, operating current should be decided after considering the ambient maximum temperature.
- (3) LEDs must be stored to maintain a clean atmosphere. If the LEDs are stored for 3 months or more after being shipped from ShineOn, a sealed container with a nitrogen atmosphere should be used for storage.
- (4) The LEDs must be used within seven days after opening the moisture proof packing. Repack unused Products with anti-moisture packing, fold to close any opening and then store in a dry place.
- (5) The appearance and specifications of the product may be modified for improvement without notice.
- (6) This LED is sensitive to the static electricity and surge. It is recommended to use a wrist Band or anti-electrostatic glove when handling the LEDs.
- (7) On manual soldering, a solder tip must be needed as grounded for usage. If over voltage which exceeds the absolute maximum rating is applied to LEDs, it will cause damage LEDs and result in destruction. Damaged LEDs will show some unusual characteristics such as leak current remarkably increase, turn-on voltage becomes lower and the LEDs get unlighted at low current.