

High Voltage Ultrafast Rectifier

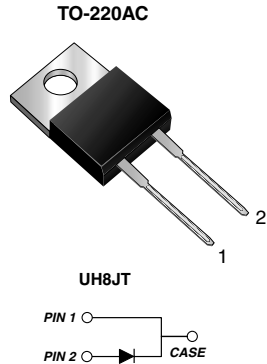

FEATURES

- Oxide planar chip junction
- Ultrafast recovery time
- Soft recovery characteristics
- Low switching losses, high efficiency
- High forward surge capability
- Solder Dip 260 °C, 40 seconds
- Component in accordance to RoHS 2002/95/EC and WEEE 2002/96/EC



TYPICAL APPLICATIONS

For use in high voltage continuous mode power factor correctors (CCM PFC), switching mode power supplies, freewheeling diodes and secondary dc-to-dc rectification application.

MECHANICAL DATA

Case: TO-220AC, ITO-220AC

Epoxy meets UL 94V-0 flammability rating

Terminals: Matte tin plated leads, solderable per J-STD-002B and JESD22-B102D

E3 suffix for commercial grade

Polarity: As marked

Mounting Torque: 10 in-lbs maximum

MAJOR RATINGS AND CHARACTERISTICS	
$I_{F(AV)}$	8 A
V_{RRM}	600 V
I_{FSM}	80 A
t_{rr}	25 ns
V_F	1.47 V
$T_j \text{ max.}$	175 °C

MAXIMUM RATINGS ($T_C = 25\text{ °C}$ unless otherwise noted)			
PARAMETER	SYMBOL	UH8JT	UNIT
Maximum repetitive peak reverse voltage	V_{RRM}	600	V
Maximum average forward rectified current (see Fig. 1)	$I_{F(AV)}$	8	A
Peak forward surge current 8.3 ms single half sine-wave superimposed on rated load	I_{FSM}	80	A
Operating junction and storage temperature range	T_J, T_{STG}	- 55 to + 175	°C

ELECTRICAL CHARACTERISTICS ($T_C = 25\text{ °C}$ unless otherwise noted)					
PARAMETER	TEST CONDITIONS	SYMBOL	TYP.	MAX.	UNIT
Instantaneous forward voltage ⁽¹⁾	$I_F = 4\text{ A}$ $I_F = 8\text{ A}$ $T_J = 25\text{ °C}$	V_F	1.82	-	V
			2.30	3.0	
	$I_F = 4\text{ A}$ $I_F = 8\text{ A}$ $T_J = 125\text{ °C}$		1.20	-	
			1.47	1.8	
Reverse current ⁽¹⁾	at $V_R = 600\text{ V}$ $T_J = 25\text{ °C}$ $T_J = 125\text{ °C}$	I_R	-	5.0 100	μA

ELECTRICAL CHARACTERISTICS ($T_C = 25\text{ }^\circ\text{C}$ unless otherwise noted)					
PARAMETER	TEST CONDITIONS	SYMBOL	TYP.	MAX.	UNIT
Maximum reverse recovery time	at $I_F = 0.5\text{ A}$, $I_R = 1.0\text{ A}$, $I_{rr} = 0.25\text{ A}$	t_{rr}	-	25	ns
	at $I_F = 1.0\text{ A}$, $di/dt = 50\text{ A}/\mu\text{s}$, $V_R = 30\text{ V}$, $I_{rr} = 0.1 I_{RM}$		-	45	
Typical softness factor (t_b/t_a)	$I_F = 8\text{ A}$, $di/dt = 200\text{ A}/\mu\text{s}$, $V_R = 400\text{ V}$, $T_J = 125\text{ }^\circ\text{C}$	S	0.5	-	-
Typical reverse recovery current		I_{RM}	7.0	7.7	A
Typical stored charge		Q_{rr}	160	-	nC
Typical forward recovery time	at $I_F = 8\text{ A}$, $di/dt = 64\text{ A}/\mu\text{s}$, $V_F = 1.1 \times V_{F\text{ max}}$	t_{fr}	150	-	ns

Note:

(1) Pulse test: 300 μs pulse width, 1 % duty cycle

THERMAL CHARACTERISTICS ($T_C = 25\text{ }^\circ\text{C}$ unless otherwise noted)			
PARAMETER	SYMBOL	UH8JT	UNIT
Typical thermal resistance from junction to case	$R_{\theta JC}$	2.0	$^\circ\text{C}/\text{W}$

ORDERING INFORMATION (Example)					
PACKAGE	PREFERRED P/N	UNIT WEIGHT (g)	PACKAGE CODE	BASE QUANTITY	DELIVERY MODE
TO-220AC	UH8JT-E3/45	1.83	45	50/Tube	Tube

RATINGS AND CHARACTERISTICS CURVES

($T_A = 25\text{ }^\circ\text{C}$ unless otherwise noted)

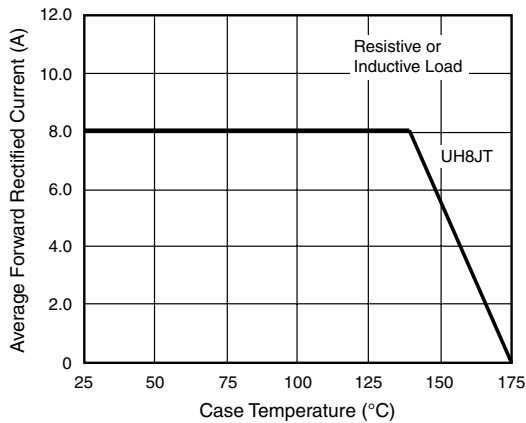

Figure 1. Maximum Forward Current Derating Curve

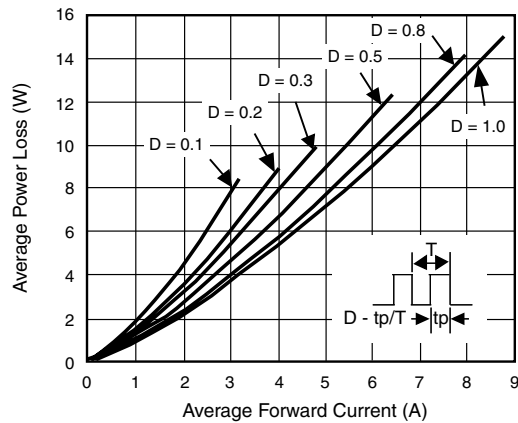

Figure 2. Forward Power Loss Characteristics

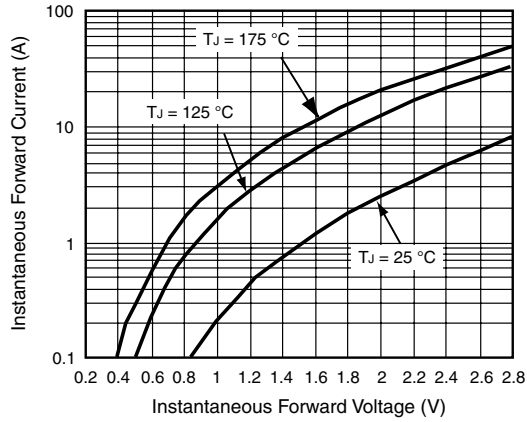

Figure 3. Typical Instantaneous Forward Characteristics

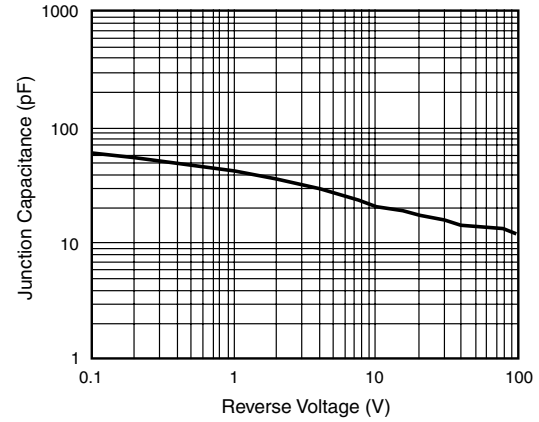

Figure 5. Typical Junction Capacitance

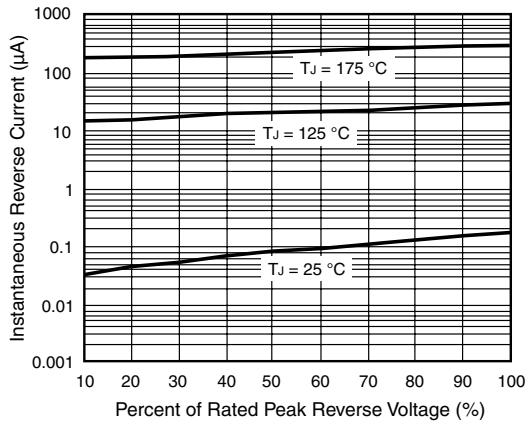

Figure 4. Typical Reverse Leakage Characteristics

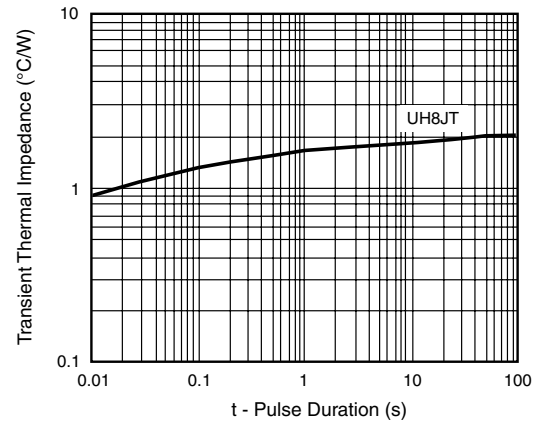
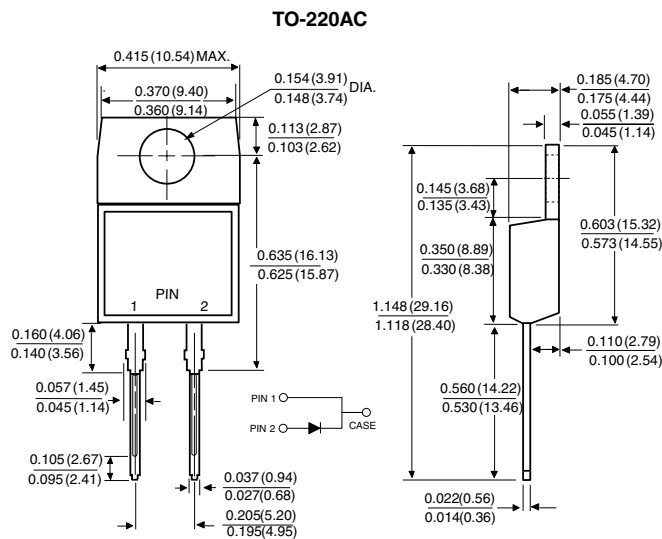

Figure 6. Typical Transient Thermal Impedance

PACKAGE OUTLINE DIMENSIONS in inches (millimeters)





Notice

Specifications of the products displayed herein are subject to change without notice. Vishay Intertechnology, Inc., or anyone on its behalf, assumes no responsibility or liability for any errors or inaccuracies.

Information contained herein is intended to provide a product description only. No license, express or implied, by estoppel or otherwise, to any intellectual property rights is granted by this document. Except as provided in Vishay's terms and conditions of sale for such products, Vishay assumes no liability whatsoever, and disclaims any express or implied warranty, relating to sale and/or use of Vishay products including liability or warranties relating to fitness for a particular purpose, merchantability, or infringement of any patent, copyright, or other intellectual property right.

The products shown herein are not designed for use in medical, life-saving, or life-sustaining applications. Customers using or selling these products for use in such applications do so at their own risk and agree to fully indemnify Vishay for any damages resulting from such improper use or sale.