

IRG4IBC20UDPbF

INSULATED GATE BIPOLAR TRANSISTOR WITH ULTRAFAST SOFT RECOVERY DIODE UltraFast CoPack IGBT

Features

- 2.5kV, 60s insulation voltage ⑤
- 4.8 mm creepage distance to heatsink
- UltraFast: Optimized for high operating frequencies 8-40 kHz in hard switching, >200 kHz in resonant mode
- IGBT co-packaged with HEXFRED™ ultrafast, ultrasoft recovery antiparallel diodes
- Tighter parameter distribution
- Industry standard Isolated TO-220 Fullpak™ outline
- Lead-Free

Benefits

- Simplified assembly
- Highest efficiency and power density
- HEXFRED™ antiparallel Diode minimizes switching losses and EMI

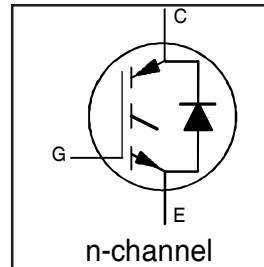

$V_{CES} = 600V$
$V_{CE(on)} \text{ typ.} = 1.85V$
@ $V_{GE} = 15V, I_C = 6.5A$

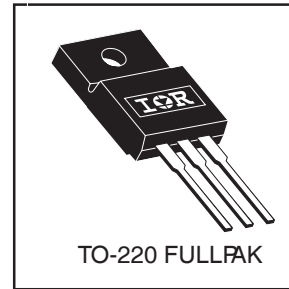

Absolute Maximum Ratings

	Parameter	Max.	Units
V_{CES}	Collector-to-Emitter Voltage	600	V
$I_C @ T_C = 25^\circ C$	Continuous Collector Current	11.4	A
$I_C @ T_C = 100^\circ C$	Continuous Collector Current	6.0	
I_{CM}	Pulsed Collector Current ①	52	
I_{LM}	Clamped Inductive Load Current ②	52	
$I_F @ T_C = 100^\circ C$	Diode Continuous Forward Current	6.5	
I_{FM}	Diode Maximum Forward Current	52	
V_{isol}	RMS Isolation Voltage, Terminal to Case⑤	2500	V
V_{GE}	Gate-to-Emitter Voltage	± 20	
$P_D @ T_C = 25^\circ C$	Maximum Power Dissipation	34	W
$P_D @ T_C = 100^\circ C$	Maximum Power Dissipation	14	
T_J	Operating Junction and	-55 to +150	°C
T_{STG}	Storage Temperature Range		
	Soldering Temperature, for 10 sec.	300 (0.063 in. (1.6mm) from case)	
	Mounting Torque, 6-32 or M3 Screw.	10 lbf•in (1.1 N•m)	

Thermal Resistance

	Parameter	Typ.	Max.	Units
$R_{\theta JC}$	Junction-to-Case - IGBT	—	3.7	°C/W
$R_{\theta JC}$	Junction-to-Case - Diode	—	5.1	
$R_{\theta JA}$	Junction-to-Ambient, typical socket mount	—	65	
W_t	Weight	2.0 (0.07)	—	g (oz)

Electrical Characteristics @ T_J = 25°C (unless otherwise specified)

	Parameter	Min.	Typ.	Max.	Units	Conditions
V _{(BR)CES}	Collector-to-Emitter Breakdown Voltage ^③	600	—	—	V	V _{GE} = 0V, I _C = 250μA
ΔV _{(BR)CES} /ΔT _J	Temperature Coeff. of Breakdown Voltage	—	0.69	—	V/°C	V _{GE} = 0V, I _C = 1.0mA
V _{CE(on)}	Collector-to-Emitter Saturation Voltage	—	1.85	2.1	V	I _C = 6.5A V _{GE} = 15V
		—	2.27	—		I _C = 13A See Fig. 2, 5
		—	1.87	—		I _C = 6.5A, T _J = 150°C
V _{GE(th)}	Gate Threshold Voltage	3.0	—	6.0		V _{CE} = V _{GE} , I _C = 250μA
ΔV _{GE(th)} /ΔT _J	Temperature Coeff. of Threshold Voltage	—	-11	—	mV/°C	V _{CE} = V _{GE} , I _C = 250μA
g _{fe}	Forward Transconductance ^④	1.4	4.3	—	S	V _{CE} = 100V, I _C = 6.5A
I _{CES}	Zero Gate Voltage Collector Current	—	—	250	μA	V _{GE} = 0V, V _{CE} = 600V
		—	—	1700		V _{GE} = 0V, V _{CE} = 600V, T _J = 150°C
V _{FM}	Diode Forward Voltage Drop	—	1.4	1.7	V	I _C = 8.0A See Fig. 13
		—	1.3	1.6		I _C = 8.0A, T _J = 150°C
I _{GES}	Gate-to-Emitter Leakage Current	—	—	±100	nA	V _{GE} = ±20V

Switching Characteristics @ T_J = 25°C (unless otherwise specified)

	Parameter	Min.	Typ.	Max.	Units	Conditions
Q _g	Total Gate Charge (turn-on)	—	27	41	nC	I _C = 6.5A
Q _{ge}	Gate - Emitter Charge (turn-on)	—	4.5	6.8		V _{CC} = 400V See Fig. 8
Q _{gc}	Gate - Collector Charge (turn-on)	—	10	16		V _{GE} = 15V
t _{d(on)}	Turn-On Delay Time	—	39	—	ns	T _J = 25°C
t _r	Rise Time	—	15	—		I _C = 6.5A, V _{CC} = 480V
t _{d(off)}	Turn-Off Delay Time	—	93	140		V _{GE} = 15V, R _G = 50Ω
t _f	Fall Time	—	110	170		Energy losses include "tail" and diode reverse recovery.
E _{on}	Turn-On Switching Loss	—	0.16	—	mJ	See Fig. 9, 10, 11, 18
E _{off}	Turn-Off Switching Loss	—	0.13	—		
E _{ts}	Total Switching Loss	—	0.29	0.3		
t _{d(on)}	Turn-On Delay Time	—	38	—	ns	T _J = 150°C, See Fig. 9, 10, 11, 18
t _r	Rise Time	—	17	—		I _C = 6.5A, V _{CC} = 480V
t _{d(off)}	Turn-Off Delay Time	—	100	—		V _{GE} = 15V, R _G = 50Ω
t _f	Fall Time	—	220	—		Energy losses include "tail" and diode reverse recovery.
E _{ts}	Total Switching Loss	—	0.49	—	mJ	
L _E	Internal Emitter Inductance	—	7.5	—	nH	Measured 5mm from package
C _{ies}	Input Capacitance	—	530	—	pF	V _{GE} = 0V
C _{oes}	Output Capacitance	—	39	—		V _{CC} = 30V See Fig. 7
C _{res}	Reverse Transfer Capacitance	—	7.4	—		f = 1.0MHz
t _{rr}	Diode Reverse Recovery Time	—	37	55	ns	T _J = 25°C See Fig. 14
		—	55	90		T _J = 125°C
I _{rr}	Diode Peak Reverse Recovery Current	—	3.5	5.0	A	T _J = 25°C See Fig. 15
		—	4.5	8.0		T _J = 125°C
Q _{rr}	Diode Reverse Recovery Charge	—	65	138	nC	T _J = 25°C See Fig. 16
		—	124	360		T _J = 125°C
di _(rec) M/dt	Diode Peak Rate of Fall of Recovery During t _b	—	240	—	A/μs	T _J = 25°C See Fig. 17
		—	210	—		T _J = 125°C

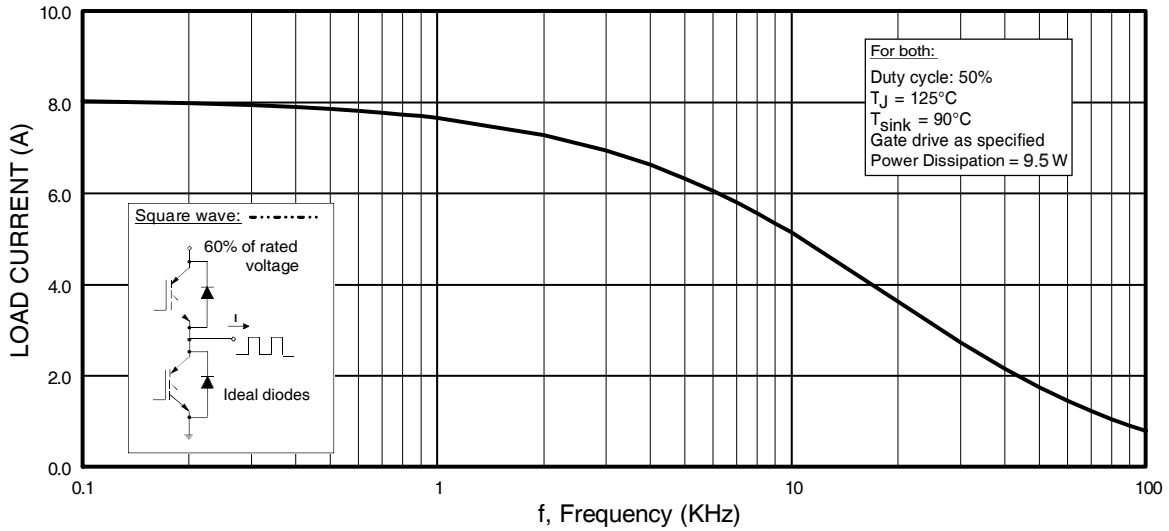

Fig. 1 - Typical Load Current vs. Frequency
 (Load Current = I_{RMS} of fundamental)

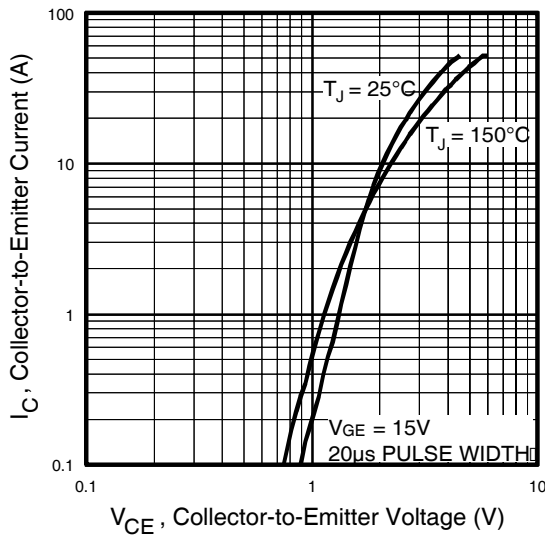

Fig. 2 - Typical Output Characteristics
www.irf.com

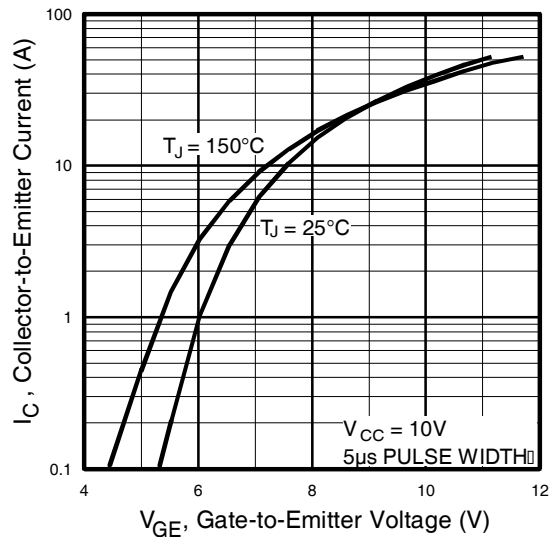

Fig. 3 - Typical Transfer Characteristics

IRG4IBC20UDPbF

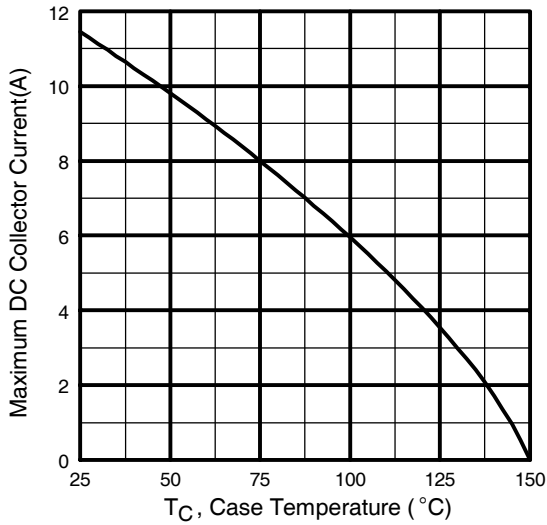

Fig. 4 - Maximum Collector Current vs. Case Temperature

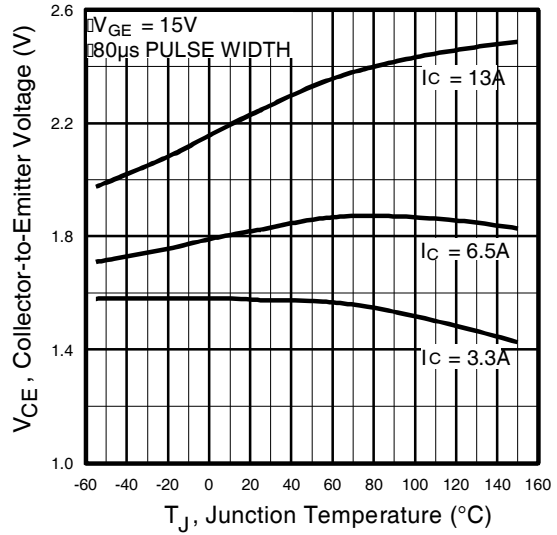

Fig. 5 - Typical Collector-to-Emitter Voltage vs. Junction Temperature

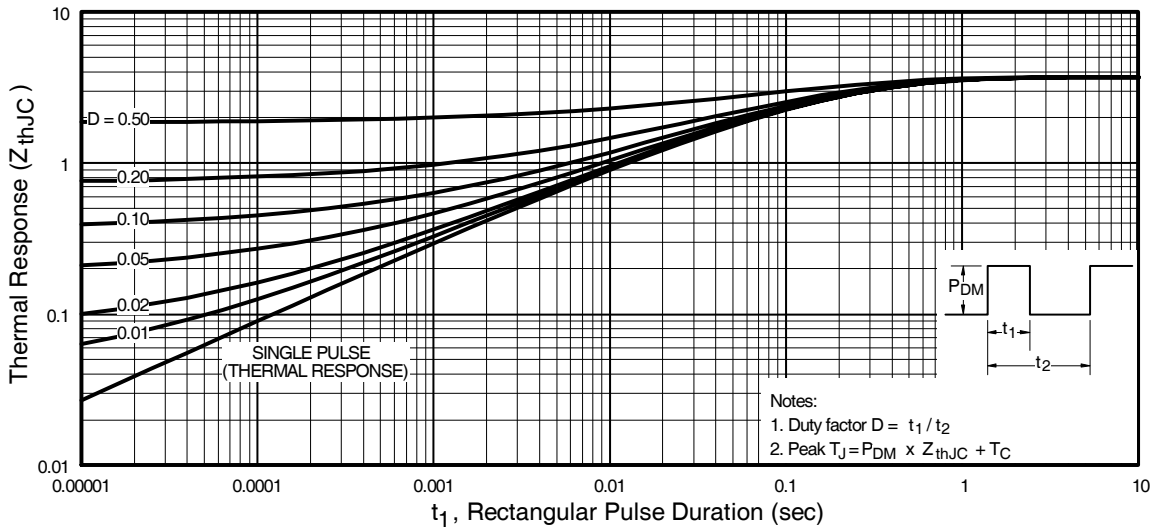

Fig. 6 - Maximum IGBT Effective Transient Thermal Impedance, Junction-to-Case

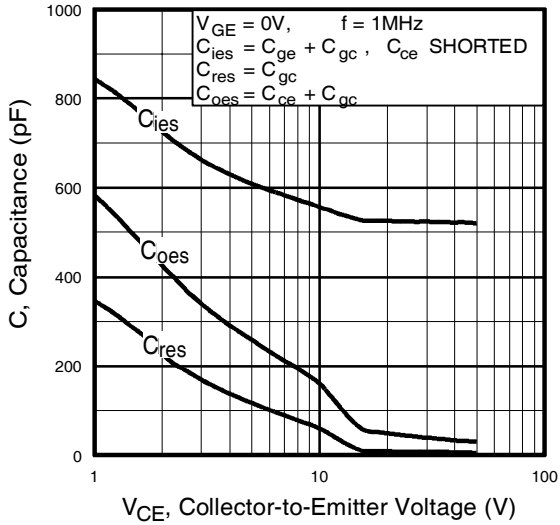

Fig. 7 - Typical Capacitance vs. Collector-to-Emitter Voltage

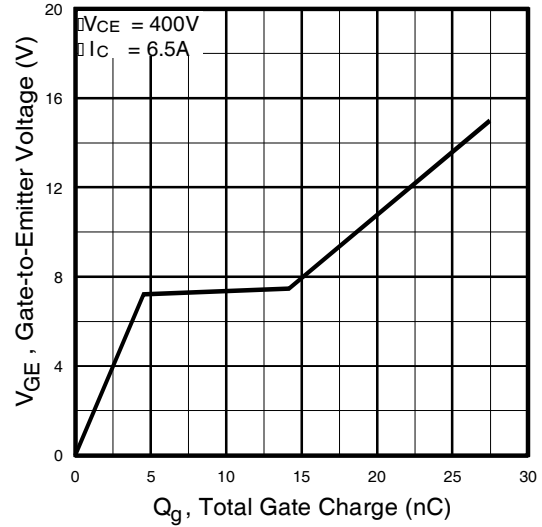

Fig. 8 - Typical Gate Charge vs. Gate-to-Emitter Voltage

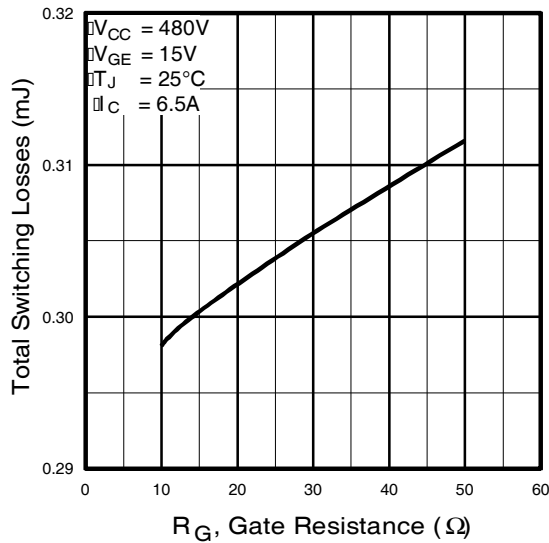

Fig. 9 - Typical Switching Losses vs. Gate Resistance

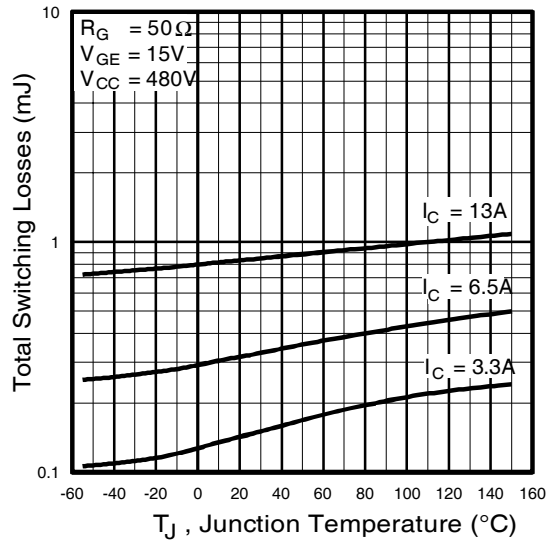

Fig. 10 - Typical Switching Losses vs. Junction Temperature

IRG4IBC20UDPbF

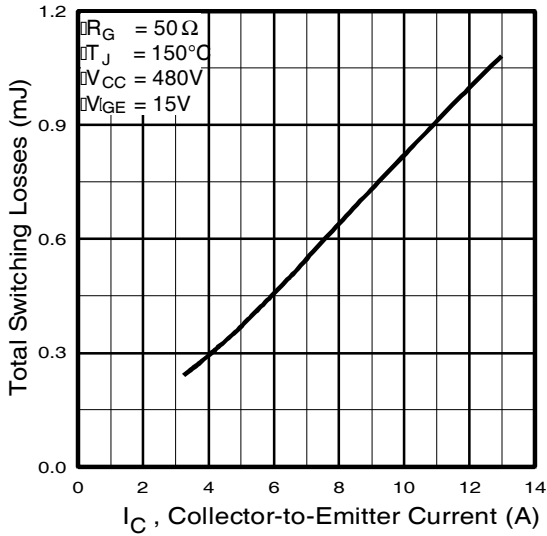

Fig. 11 - Typical Switching Losses vs. Collector-to-Emitter Current

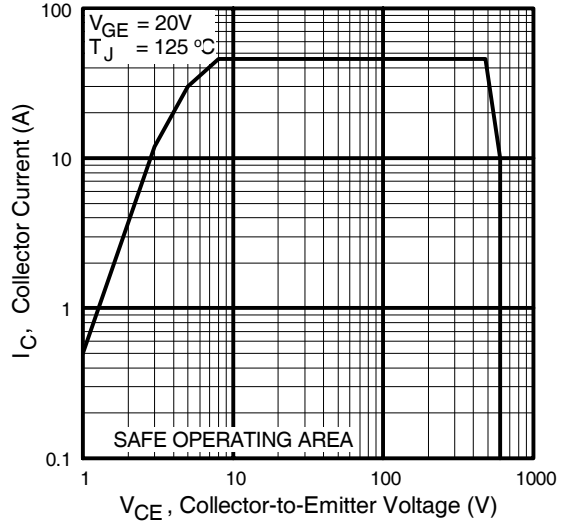

Fig. 12 - Turn-Off SOA

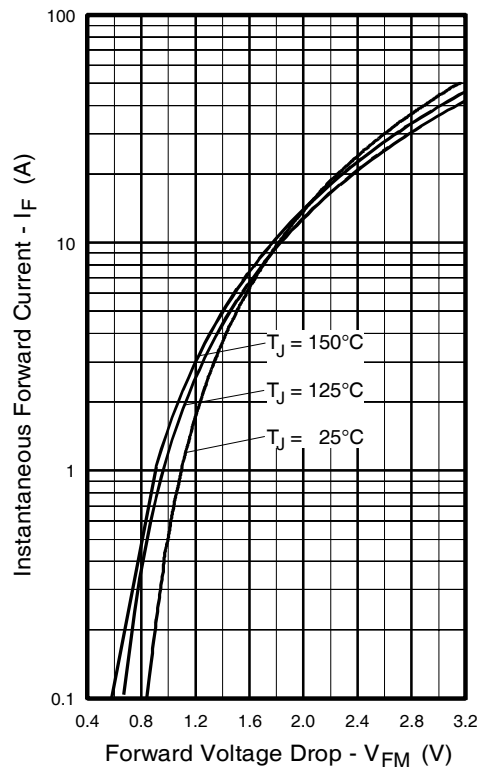

Fig. 13 - Maximum Forward Voltage Drop vs. Instantaneous Forward Current

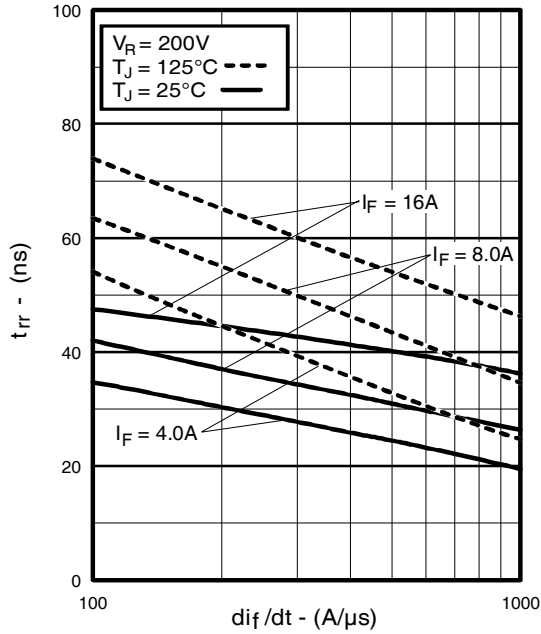

Fig. 14 - Typical Reverse Recovery vs. di_f/dt

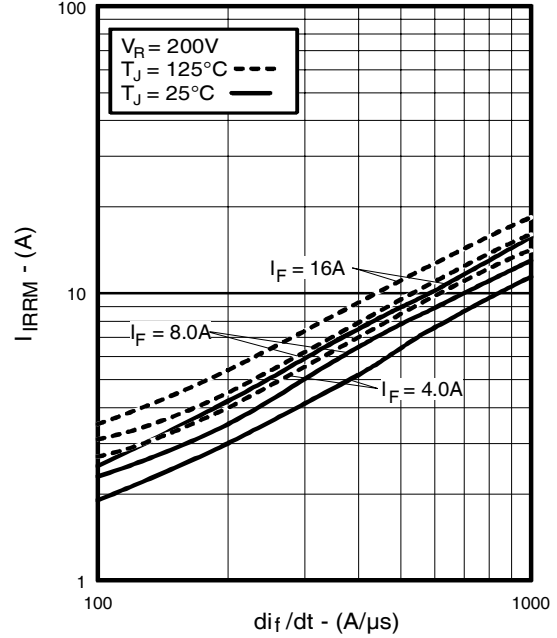

Fig. 15 - Typical Recovery Current vs. di_f/dt

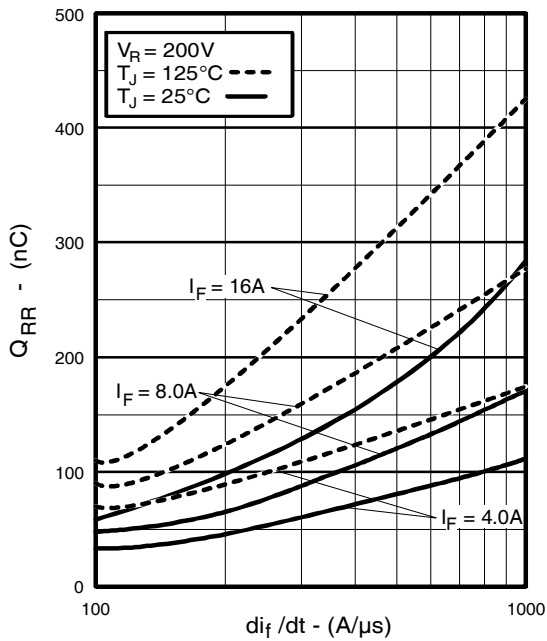

Fig. 16 - Typical Stored Charge vs. di_f/dt
www.irf.com

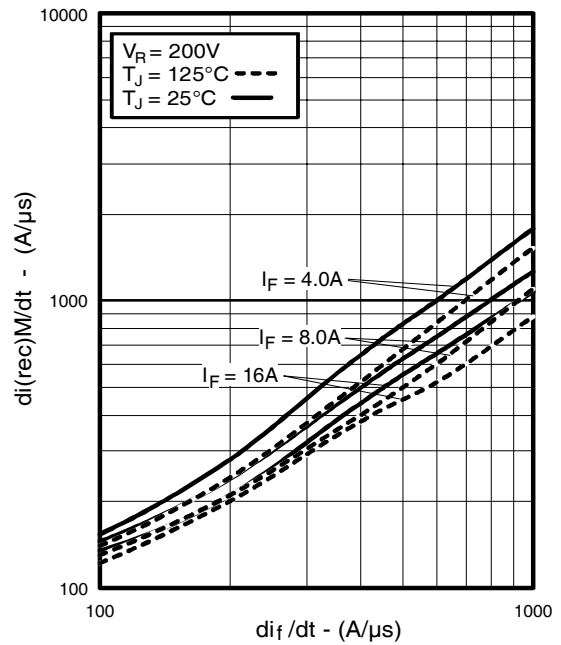

Fig. 17 - Typical $di_{(rec)M}/dt$ vs. di_f/dt

IRG4IBC20UDPbF

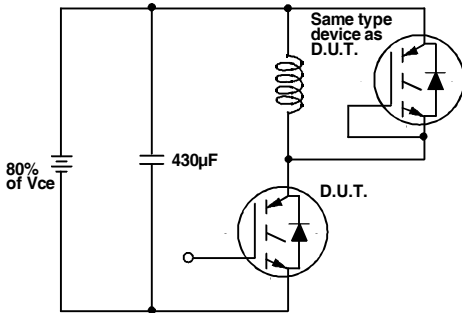

Fig. 18a - Test Circuit for Measurement of I_{LM} , E_{on} , $E_{off}(\text{diode})$, t_{rr} , Q_{rr} , I_{rr} , $t_{d(on)}$, t_r , $t_{d(off)}$, t_f

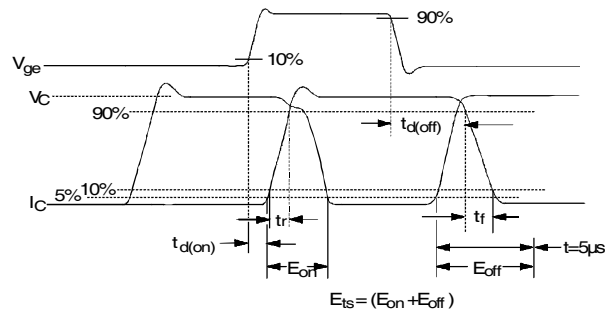

Fig. 18b - Test Waveforms for Circuit of Fig. 18a, Defining E_{off} , $t_{d(off)}$, t_f

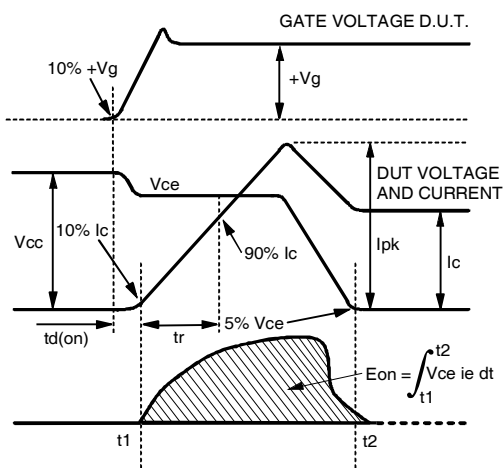

Fig. 18c - Test Waveforms for Circuit of Fig. 18a, Defining E_{on} , $t_{d(on)}$, t_r

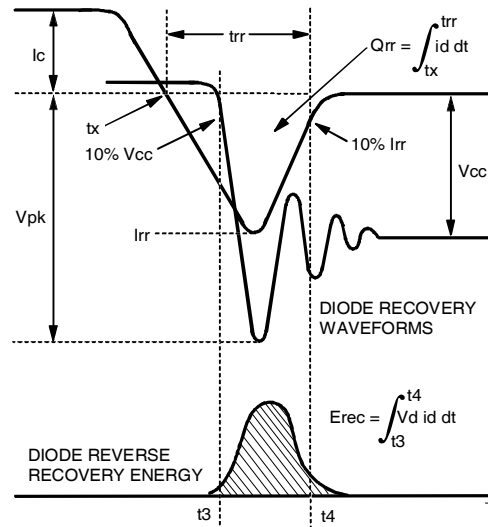

Fig. 18d - Test Waveforms for Circuit of Fig. 18a, Defining E_{rec} , t_{rr} , Q_{rr} , I_{rr}

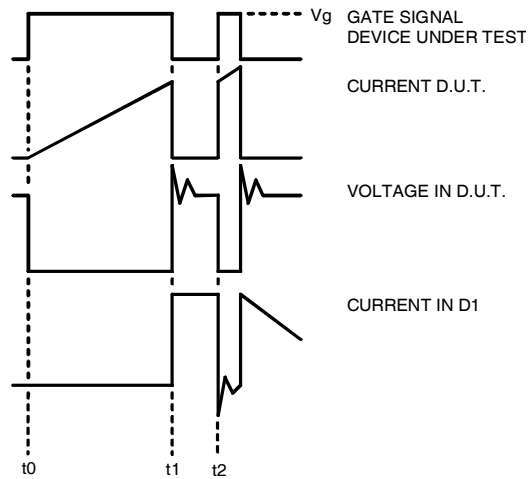

Figure 18e. Macro Waveforms for Figure 18a's Test Circuit

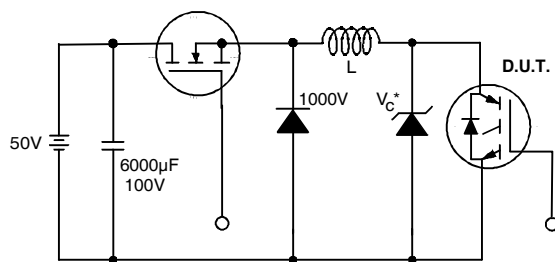

Figure 19. Clamped Inductive Load Test Circuit

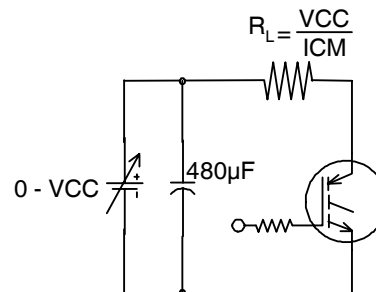

Figure 20. Pulsed Collector Current Test Circuit

IRG4IBC20UDPbF



TO-220AB Full-Pak Package Outline

Dimensions are shown in millimeters (inches)

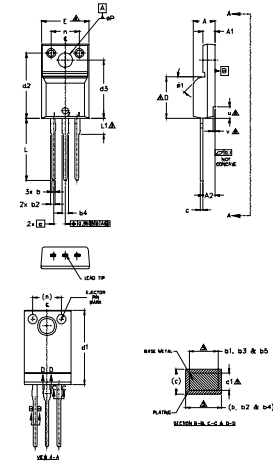

SYMBOL	DIMENSIONS				NOTES
	MILLIMETERS		INCHES		
	MIN.	MAX.	MIN.	MAX.	
A	4.57	4.83	.180	.190	1.0 DIMENSIONS AND TOLERANCING AS PER ASME Y14.5 M- 1994
A1	2.57	2.83	.101	.111	2.0 DIMENSIONS ARE SHOWN IN MILLIMETERS (INCHES)
A2	2.51	2.93	.099	.115	3.0 LEAD DIMENSION AND PITCH UNCONTROLLED IN LE
b	0.61	0.94	.024	.037	4.0 DIMENSIONS D & E DO NOT INCLUDE WELD FLASH. WELD FLASH SHALL NOT EXCEED .203 (0.007) PER SIDE. THESE DIMENSIONS ARE MEASURED AT THE OUTER MOST EXTREMES OF THE PLASTIC BODY.
b1	0.61	0.89	.024	.035	5.0 DIMENSION D1, D2, D3 & D4 OF APPLY TO BRASS METAL ONLY.
b2	0.76	1.27	.030	.050	6.0 STEP OPTIMAL ON PLASTIC BODY DETERM BY DIMENSIONS * & *.
b3	0.76	1.22	.030	.048	7.0 CONTROLLING DIMENSION - INCHES.
b4	1.02	1.52	.040	.060	
b5	1.02	1.47	.040	.058	
c	0.33	0.63	.013	.025	
c1	0.33	0.58	.013	.023	
D	8.66	9.80	.341	.386	
d1	15.80	16.13	.622	.635	
d2	13.97	14.22	.550	.560	
d3	12.30	12.93	.484	.509	
E	9.63	10.76	.379	.423	
e	2.54	BSC	.100	BSC	
L	13.20	13.72	.520	.540	
L1	3.37	3.67	.122	.145	
n	6.05	6.60	.238	.260	
pp	3.05	3.45	.120	.136	
u	2.40	2.50	.094	.098	
y	0.40	0.50	.016	.020	
Ø1	-	45°	-	45°	

- NOTES:
- DIMENSIONS AND TOLERANCING AS PER ASME Y14.5 M- 1994
 - DIMENSIONS ARE SHOWN IN MILLIMETERS (INCHES)
 - LEAD DIMENSION AND PITCH UNCONTROLLED IN LE
 - DIMENSIONS D & E DO NOT INCLUDE WELD FLASH. WELD FLASH SHALL NOT EXCEED .203 (0.007) PER SIDE. THESE DIMENSIONS ARE MEASURED AT THE OUTER MOST EXTREMES OF THE PLASTIC BODY.
 - DIMENSION D1, D2, D3 & D4 OF APPLY TO BRASS METAL ONLY.
 - STEP OPTIMAL ON PLASTIC BODY DETERM BY DIMENSIONS * & *.
 - CONTROLLING DIMENSION - INCHES.
- LEAD ASSIGNMENTS
- 1- GATE
 - 2- DIODE
 - 3- SOURCE
- WELD DESIGN
- 1- GATE
 - 2- COLLECTOR
 - 3- DIODE

TO-220AB Full-Pak Part Marking Information

EXAMPLE: THIS IS AN IRFI840G
WITH ASSEMBLY
LOT CODE 3432
ASSEMBLED ON WW 24, 2001
IN THE ASSEMBLY LINE 'K'

Note: 'P' in assembly line position
indicates 'Lead-Free'

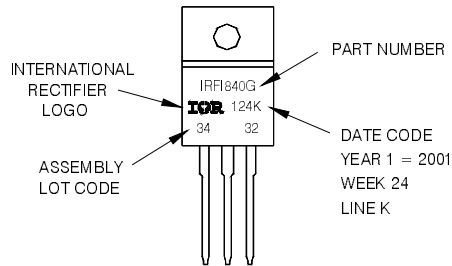

TO-220AB Full-Pak package is not recommended for Surface Mount Application.

Notes:

- Repetitive rating: $V_{GE}=20V$; pulse width limited by maximum junction temperature (figure 20)
- $V_{CC}=80\%(V_{CES})$, $V_{GE}=20V$, $L=10\mu H$, $R_G = 50\Omega$ (figure 19)
- Pulse width $\leq 80\mu s$; duty factor $\leq 0.1\%$.
- Pulse width $5.0\mu s$, single shot.
- $t = 60s$, $f = 60Hz$

Note: For the most current drawing please refer to IR website at <http://www.irf.com/package/>

Data and specifications subject to change without notice.



IR WORLD HEADQUARTERS: 233 Kansas St., El Segundo, California 90245, USA Tel: (310) 252-7105
TAC Fax: (310) 252-7903

Visit us at www.irf.com for sales contact information.01/2010