



SPECIFICATIONS

CUSTOMER	:	CNO003
SAMPLE CODE	:	PS240128WRF-001H05
MASS PRODUCTION CODE	:	PE240128WRF001HC1Q
SAMPLE VERSION	:	01
SPECIFICATIONS EDITION	:	003
DRAWING NO. (Ver.)	:	DMD-08200(Ver.001)
PACKAGING NO. (Ver.)	:	DPK-08384(Ver.001)

Customer Approved

Date:

Approved	Checked	Designer



- Preliminary specification for design input
- Specification for sample approval

POWERTIP TECH. CORP.

Headquarters:

No.8, 6th Road, Taichung Industrial Park,
 Taichung, Taiwan
 台中市 407 工業區六路 8 號

TEL: 886-4-2355-8168
 FAX: 886-4-2355-8166

E-mail: sales@powertip.com.tw
[Http://www.powertip.com.tw](http://www.powertip.com.tw)

Contents

1. SPECIFICATIONS

- 1.1 Features
- 1.2 Mechanical Specifications
- 1.3 Absolute Maximum Ratings
- 1.4 DC Electrical Characteristics
- 1.5 Optical Characteristics
- 1.6 Backlight Characteristics

2. MODULE STRUCTURE

- 2.1 Counter Drawing
- 2.2 Interface Pin Description
- 2.3 Timing Characteristics
- 2.4 Display command

3. QUALITY ASSURANCE SYSTEM

- 3.1 Quality Assurance Flow Chart
- 3.2 Inspection Specification

4. RELIABILITY TEST

- 4.1 Reliability Test Condition

5. PRECAUTION RELATING PRODUCT HANDLING

- 5.1 Safety
- 5.2 Handling
- 5.3 Storage
- 5.4 Terms of Warranty

- Appendix:
- 1. LCM Drawing
 - 2. Packing Specification
 - 3. Customer's circuit (For reference only)
 - 4. Software

1. SPECIFICATIONS

1.1 Features

Item	Standard Value
Display Type	240*128 dots
LCD Type	FSTN,Positive,Transflective,Extend Temp.
Driver Condition	LCD Module :1/160Duty,1/10Bias
Viewing Direction	6 O'clock
Backlight	White LED B/L
Weight	-
Interface	Support 8 bit parallel interface with 8080 or 6800 series MPU
Other(controller / driver IC)	ST7529-G
ROHS	THIS PRODUCT CONFORMS THE ROHS OF PTC Detail information please refer web side : http://www.powertip.com.tw/news/LatestNews.asp

1.2 Mechanical Specifications

Item	Standard Value	Unit
Outline Dimension	99.2(L) * 64.2(W) * 5.4(H)	mm
Viewing Area	93.0(L) * 49.0(W)	mm
Active Area	82.775(L) * 44.135(W)	mm
Dot Size	0.32(L) * 0.32(W)	mm
Dot Pitch	0.345(L) * 0.345(W)	mm

Note : For detailed information please refer to LCM drawing

1.3 Absolute Maximum Ratings

Item	Symbol	Condition	Min.	Max.	Unit
Power Supply Voltage	V_{dd}	—	-0.5	4.0	V
LCD Driver Supply Voltage	V_{LCD}	—	-0.5	20	V
Input Voltage	V_{IN}	—	-0.5	$V_{DD}+0.5$	V
Operating Temperature	T_{OP}	—	-20	70	°C
Storage Temperature	T_{ST}	—	-30	80	°C
Storage Humidity	H_D	$T_a < 60\text{ °C}$	-	90	%RH

1.4 DC Electrical Characteristics

$V_{DD}=3.0\pm 0.3V$, $V_{SS}=0V$, $T_a=25^{\circ}C$

Item	Symbol	Condition	Min.	Typ.	Max.	Unit
Logic Supply Voltage	V_{DD}	-	2.7	3.0	3.3	V
“H” Input Voltage	V_{IH}	-	$0.7V_{DD}$	-	V_{DD}	V
“L” Input Voltage	V_{IL}	-	V_{SS}	-	$0.3V_{DD}$	V
“H” Output Voltage	V_{OH}	-	-	-	-	V
“L” Output Voltage	V_{OL}	-	-	-	-	V
Supply Current	I_{DD}	$V_{DD}=3.0V$, V_{OP} : 12.70 V Pattern= Full OFF	-	0.12	-	mA
		$V_{DD}=3.0V$, V_{OP} :12.70 V Pattern= Full display *1	-	0.14	0.3	
LCM Driver Voltage	V_{OP}^{*2}	-20°C	13.3	13.4	13.5	V
		25°C	12.55	12.7	12.85	
		70°C	11.7	11.8	11.9	

NOTE: *1 The maximum current display

*2 The V_{OP} test point is V_0-V_{SS}

1.5 Optical Characteristics

LCD Panel: 1/160 Duty, 1/13 Bias, $V_{LCD} = 15.0 \text{ V}$, $T_a = 25^\circ\text{C}$

Item		Symbol	Conditions	Min.	Typ.	Max.	Unit	Reference
Response Time	Rise	tr	$C \geq 2.0$, $\phi = 270$	-	135	205	ms	Note2
	Fall	tf		-	300	450		
Viewing angle range	Top	$\theta Y+$		+45	-	-	Deg.	Notes 1
	Bottom	$\theta Y-$		-40	-	-		
	Left	$\theta X-$	R45	-	-			
	Right	$\theta X+$	L40	-	-			
Contrast Ratio		C	-	6	8	-	-	Note 3
Average Brightness (with LCD) *2		IV	If=80 mA	40	55	-	cd/m ²	-
CIE Color Coordinate (With LCD)		X		0.25	0.30	0.35	-	Note 4
		Y		0.29	0.34	0.39		
Uniformity *1		ΔB	-	70	-	-	%	-

Note 4 :

1 : $\Delta B = B(\text{min}) / B(\text{max}) * 100\%$

2 : Measurement Condition for Optical Characteristics:

a : Environment: $25^\circ\text{C} \pm 5^\circ\text{C}$ / $60 \pm 20\%$ R.H , no wind , dark room below 10 Lux at typical lamp current and typical operating frequency.

b : Measurement Distance: $500 \pm 50 \text{ mm}$, ($\theta = 0^\circ$)

c : Equipment: TOPCON BM-7 fast , (field 1°) , after 10 minutes operation.

d : The uncertainty of the C.I.E coordinate measurement ± 0.01 , Average Brightness $\pm 4\%$

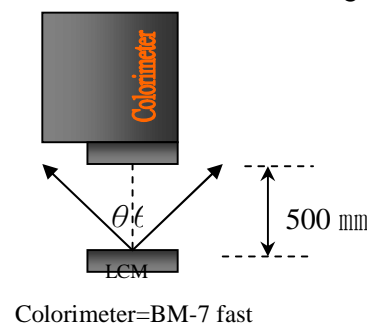
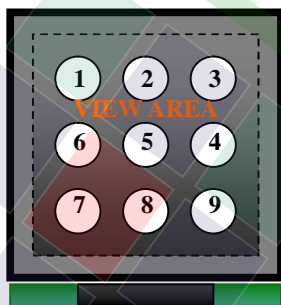

Note 1.

Optical characteristics-2

Viewing angle

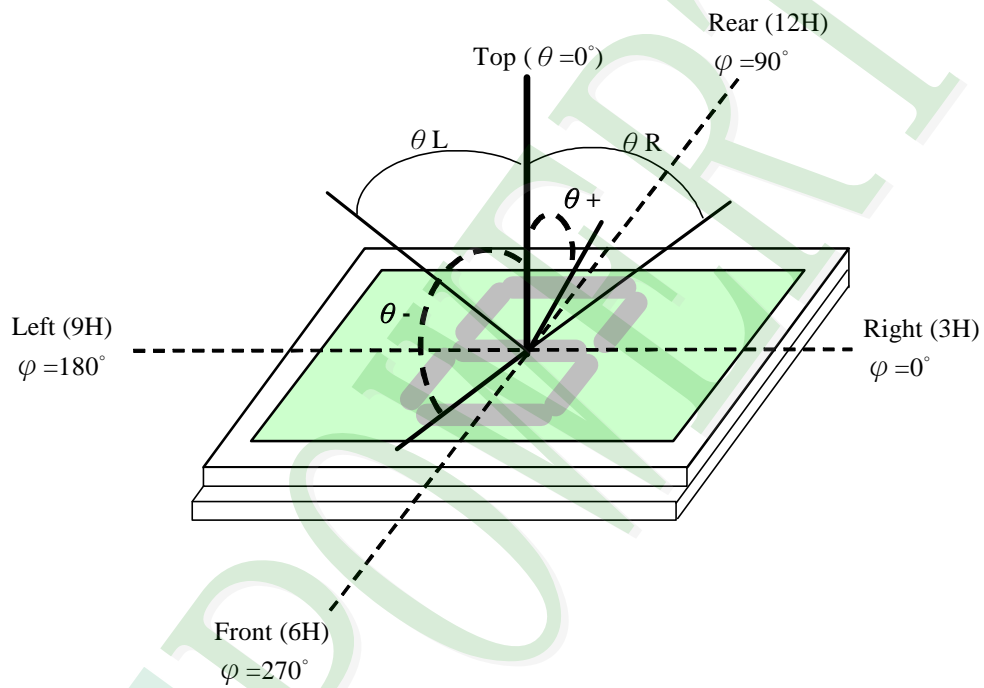

Viewing angle

Note 2.

Optical characteristics-3

Fig.2 Definition of response time

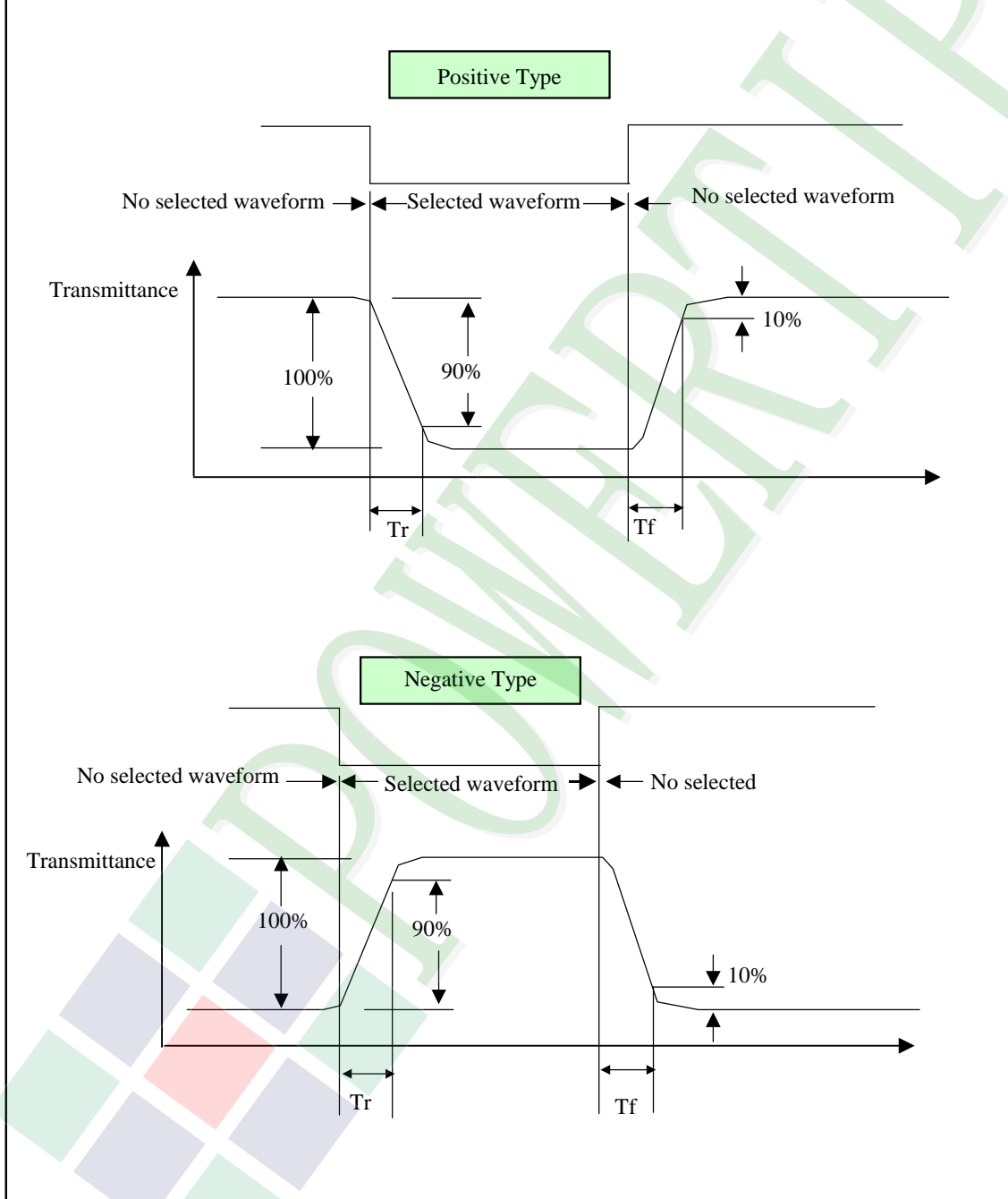

Electrical characteristics-2

※2 Drive waveform

Vop: Drive voltage

1/B: Bias

N: Duty

fF: Frame frequency

fD: Drive frequency

(1) Selected waveform

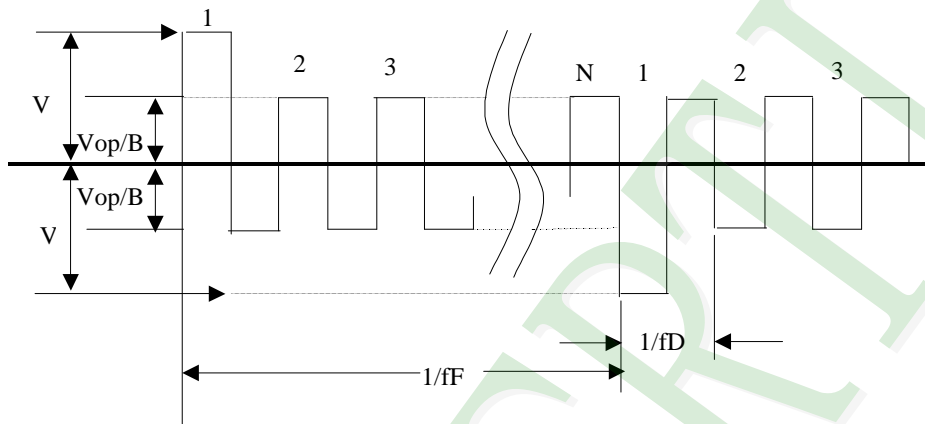

(2) Non- Selected wave form

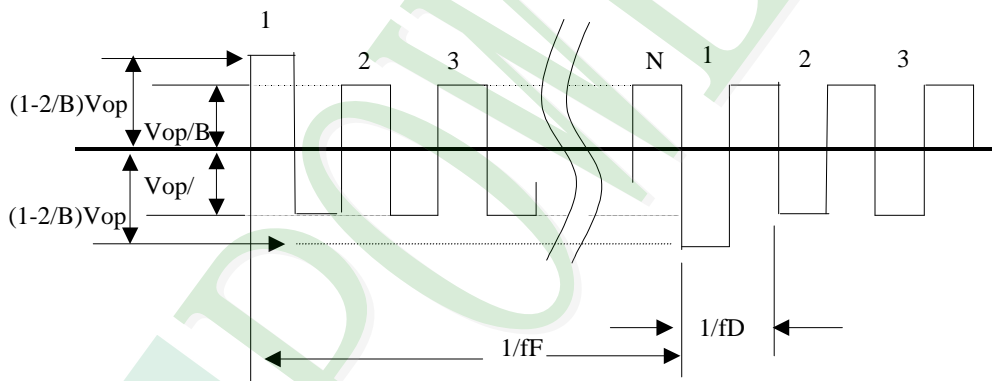

Note:

Frame frequency is defined as follows: Common side supply voltage peak - to - peak / 2 = 1 period

Note 3. : Definition of Vth

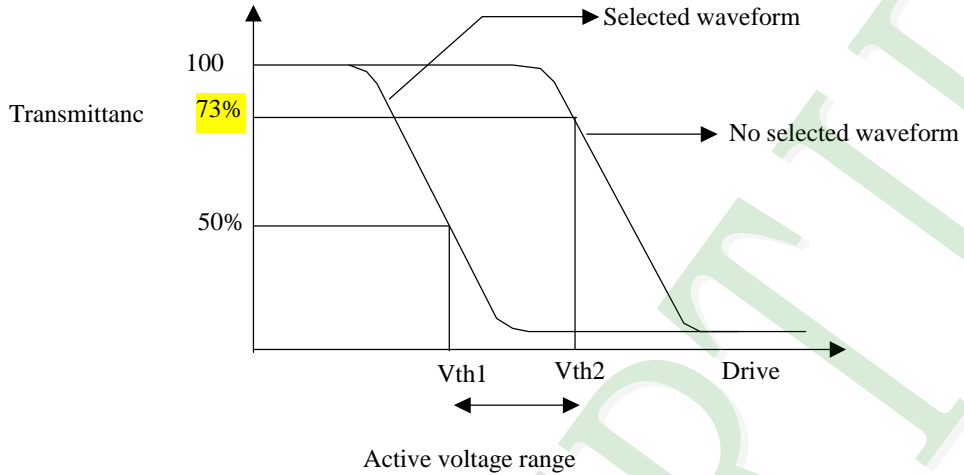

	Vth1	Vth2
View direction	10°	40°
Drive waveform	(Selected waveform)	(No selected waveform)
Transmittance	50%	73%

※1 Contrast ratio
= (Brightness in OFF state) / (Brightness in ON state)

Outline of Electro-Optical Characteristics Measuring System

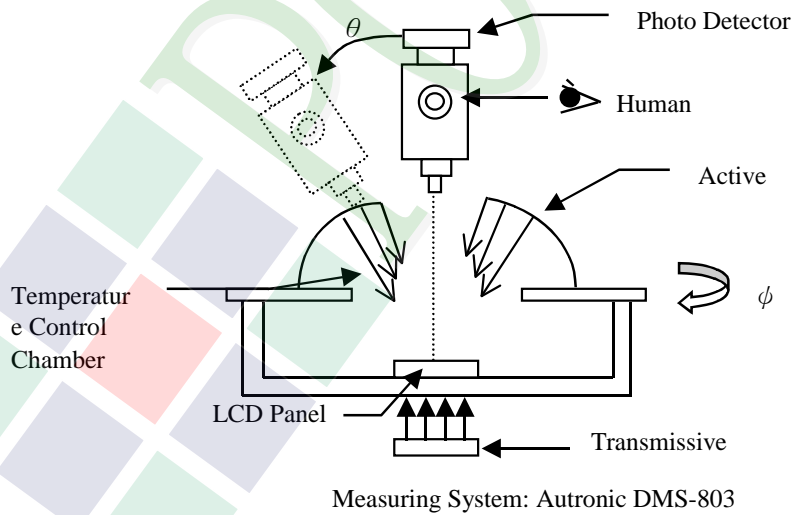

1.6 Backlight Characteristics

Electrical / Optical Characteristics

Item	Symbol	Conditions	Min.	Typ.	Max.	Unit
Forward Voltage	Vf	If=80 mA	-	3.3	3.6	V
Average Brightness (Without LCD)	IV		176	220	--	cd/m ²
Color	White					

2. MODULE STRUCTURE

2.1 Counter Drawing

2.1.1 LCM Mechanical Diagram

* See Appendix

2.1.2 Block Diagram

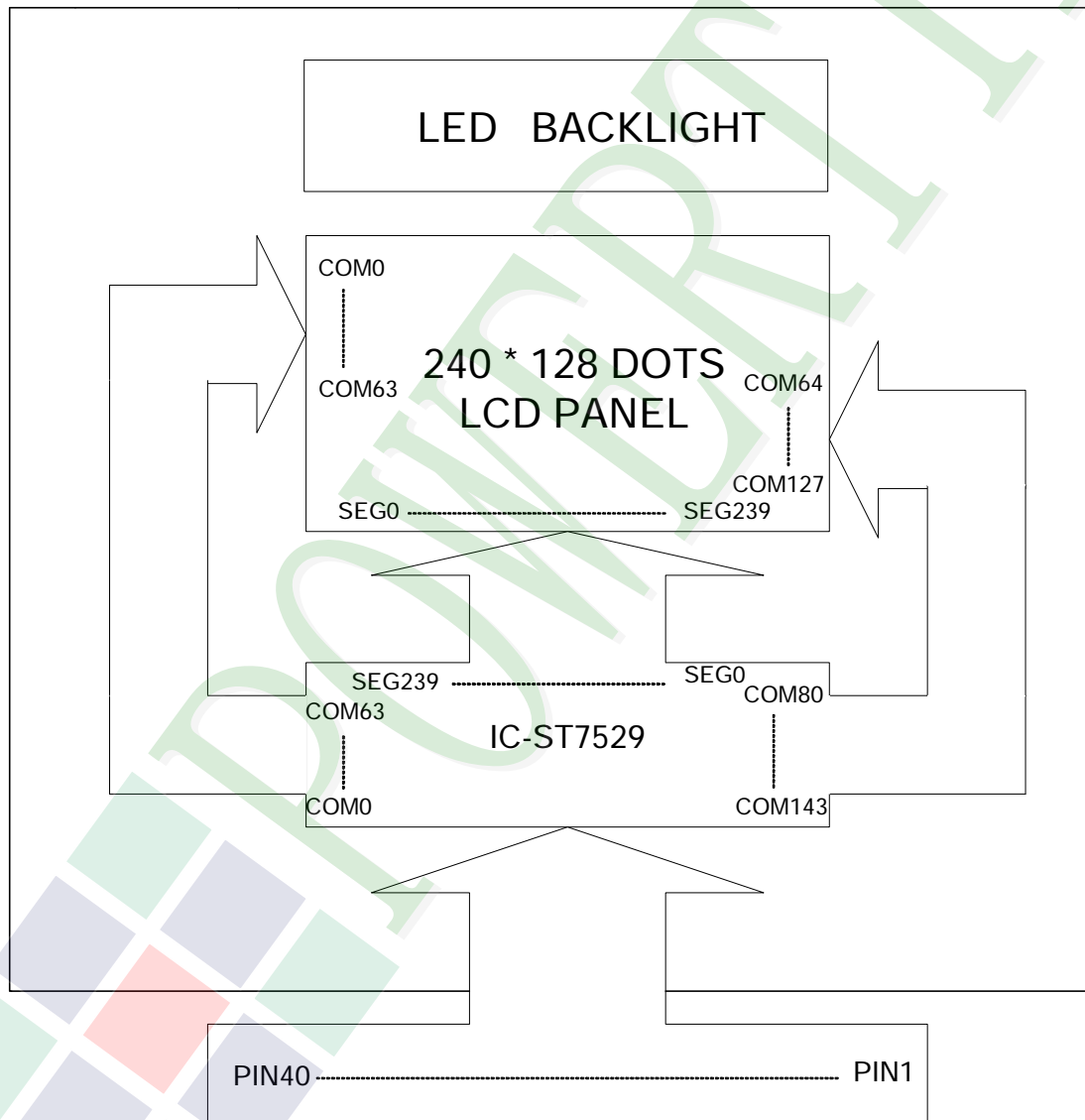

Please refer interface pin description for detail

2.2 Interface Pin Description

Pin No.	Symbol	Function								
1	A0	Register select input pin - A0 = "H": DB0 to DB8 or SI are display data - A0 = "L": DB0 to DB8 or SI are control data								
2	RW_WR	Read / Write execution control pin								
		MPU Type	RW_WR	Description	6800	RW	Read / Write control input pin RW = "H" : read RW = "L" : write	8080	/WR	Write enable clock input pin The data on DB0 to DB8 are latched at the rising edge of the /WR signal.
		MPU Type	RW_WR	Description						
6800	RW	Read / Write control input pin RW = "H" : read RW = "L" : write								
8080	/WR	Write enable clock input pin The data on DB0 to DB8 are latched at the rising edge of the /WR signal.								
3	DB0	They connect to the standard 8-bit MPU bus via the 8 bit bi-directional bus. When the following interface is selected and the XCS pin is high, the following pins become highimpedance, which should be fixed to VDD or VSS.								
4	DB1									
5	DB2									
6	DB3									
7	DB4									
8	DB5									
9	DB6									
10	DB7									
11	E_RD	Read / Write execution control pin								
		MPU Type	RW_WR	Description	6800	E	Read / Write control input pin -RW = "H": When E is "H", DB0 to DB8 are in an output status. -RW = "L": The data on DB0 to DB8 are latched at the falling edge of the E signal.	8080	/RD	Read enable clock input pin When /RD is "L", DB0 to DB8 are in an output status.
		MPU Type	RW_WR	Description						
6800	E	Read / Write control input pin -RW = "H": When E is "H", DB0 to DB8 are in an output status. -RW = "L": The data on DB0 to DB8 are latched at the falling edge of the E signal.								
8080	/RD	Read enable clock input pin When /RD is "L", DB0 to DB8 are in an output status.								
12	RST	Reset input pin. When RST is "L", initialization is executed.								

Pin No.	Symbol	Function		
13	IF1	IF1	IF3	MPU interface type
		H	L	80 series 8-bit parallel
14	IF3	L	H	68 series 8-bit parallel
15	XCS	Chip select input pins Data/instruction I/O is enabled only when XCS is "L". When chip select is non-active, DB0 to DB8 may be high impedance.		
16	VSS	Power supply (VSS=0)		
17	VDD	Power supply (VDD=3.3V)		
18	CAP7P	DC / DC voltage converter. Connect a capacitor between this terminal and the $\leq 7X$ VLCD; $8X$ CAP1N terminal.		
19	CAP1N	DC / DC voltage converter. Connect a capacitor between this terminal and the $\leq 5X$ OPEN; $\geq 6X$ also CAP5P; $\geq 8X$ also CAP7P terminal.		
20	CAP5P	DC / DC voltage converter. Connect a capacitor between this terminal and the $\leq 5X$ VLCD; $\geq 6X$ CAP1N terminal.		
21	CAP3P	DC / DC voltage converter. Connect a capacitor between this terminal and the $\leq 3X$ VLCD; $\geq 4X$ CAP1N1 terminal.		
22	CAP1N1	DC / DC voltage converter. Connect a capacitor between this terminal and the CAP1P terminal.		
23	CAP1P	DC / DC voltage converter. Connect a capacitor between this terminal and the CAP1N1 terminal.		
24	CAP2P	DC / DC voltage converter. Connect a capacitor between this terminal and the $2X$ VLCD; $\geq 3X$ CAP2N terminal.		
25	CAP2N	DC / DC voltage converter. Connect a capacitor between this terminal and the $\leq 2X$ OPEN; $\geq 3X$ CAP2P terminal.		
26	CAP4P	DC / DC voltage converter. Connect a capacitor between this terminal and the $\leq 4X$ VLCD; $\geq 5X$ CAP2N terminal.		
27	CAP2N1	DC / DC voltage converter. Connect a capacitor between this terminal and the $\leq 6X$ OPEN; $\geq 7X$ CAP6P terminal.		
28	CAP6P	DC / DC voltage converter. Connect a capacitor between this terminal and the $\leq 6X$ VLCD; $\geq 7X$ CAP2N1 terminal.		
29	VLCD	If the internal voltage generator is used, connect to a stabilizing capacitor(1uF/25V) between VSS and VLCD.		
		If an external supply is used, the external LCD supply voltage can be supplied using the VLCD pin. In this case, the internal voltage generator has to be programmed to zero(SET register VB=0). (Positive voltage: $15 \pm 0.5V$)		

Pin No.	Symbol	Function										
30	V4	LCD driver supply voltages V0In & V0out should be connected together in FPC area.										
31	V3	Voltages should have the following relationship: $V0 \geq V1 \geq V2 \geq V3 \geq V4 \geq VSS$										
32	V2	When the internal power circuit is active, these voltages are generated as the following table according to the state of LCD bias.										
33	V1	<table border="1"> <thead> <tr> <th>LCD Bias</th> <th>V1</th> <th>V2</th> <th>V3</th> <th>V4</th> </tr> </thead> <tbody> <tr> <td>1/N Bias</td> <td>$(N-1) / N \times V0$</td> <td>$(N-2) / N \times V0$</td> <td>$(2/N) \times V0$</td> <td>$(1/N) \times V0$</td> </tr> </tbody> </table>	LCD Bias	V1	V2	V3	V4	1/N Bias	$(N-1) / N \times V0$	$(N-2) / N \times V0$	$(2/N) \times V0$	$(1/N) \times V0$
		LCD Bias	V1	V2	V3	V4						
1/N Bias	$(N-1) / N \times V0$	$(N-2) / N \times V0$	$(2/N) \times V0$	$(1/N) \times V0$								
34	V0	NOTE: N = 5 to 14 Connect capacitors(1uF/25V) between these terminals and GND.										
35~37	A	Power supply for Backlight (anode)										
38~40	K	Power supply for Backlight (cathode)										

NOTE:IF an external voltage supply is used on VLCD terminal,PIN18~28:Not connect.

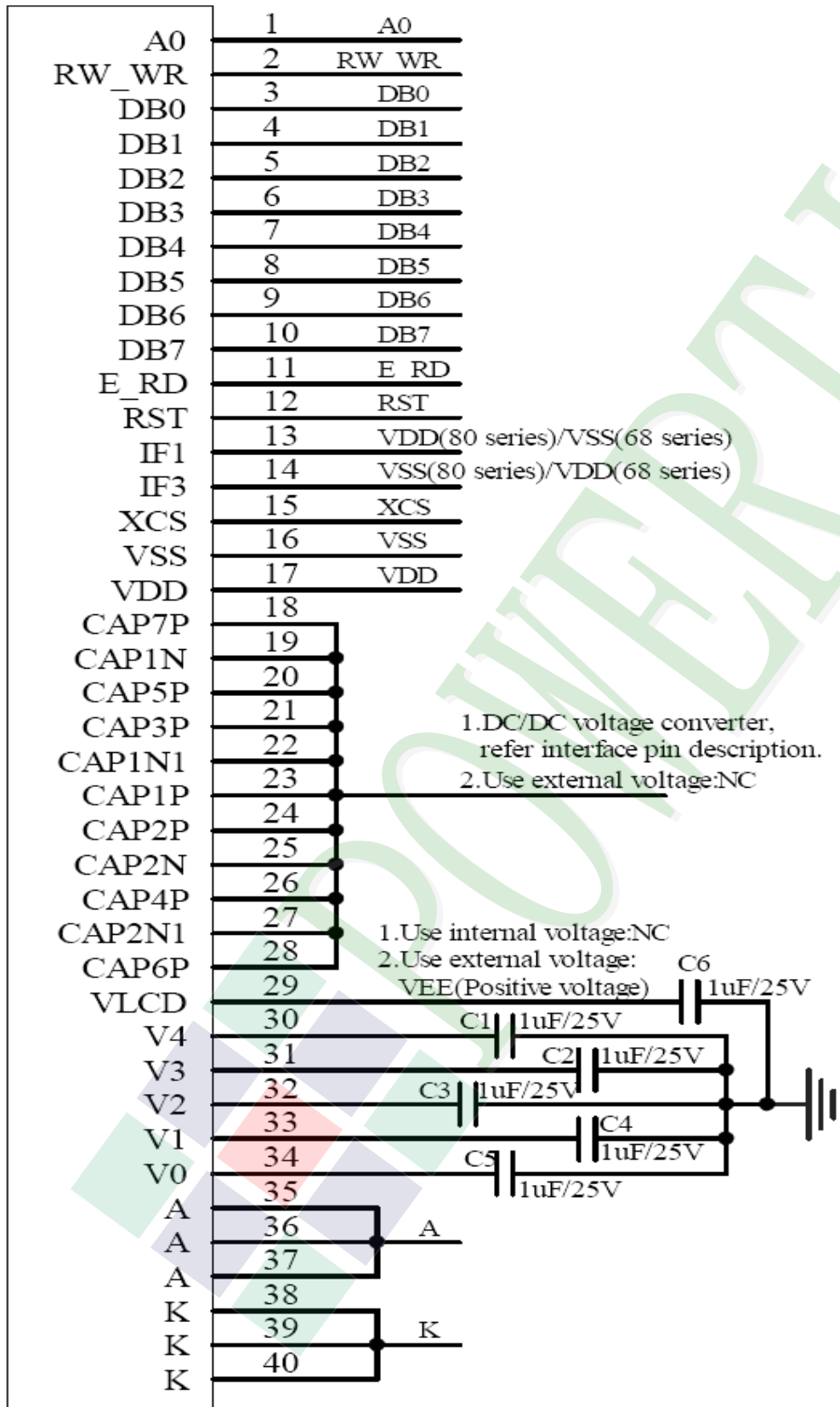
Reference circuit for using LCM module:

2.3 Timing Characteristics For the 8080 Series MPU

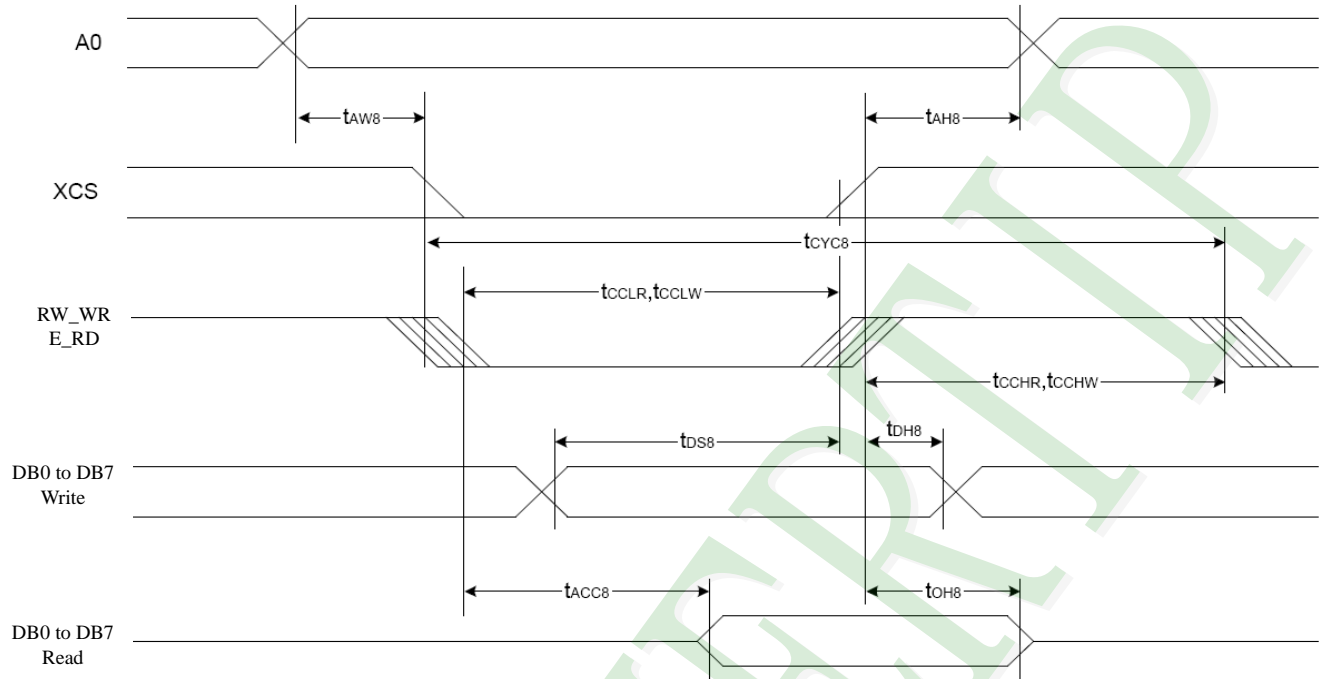

$V_{DD}=3.3V$

Item	Signal	Symbol	Condition	Rating		Units
				Min	Max	
Address hold time	A0	t_{AH8}	-	20	-	ns
Address setup time		t_{AW8}	-	20	-	
System cycle time		t_{CYC8}	-	200	-	
Enable L pulse width (Write)	RW_WR	t_{CCLW}	-	100	-	
Enable H pulse width (Write)		t_{CCHW}	-	100	-	
Enable L pulse width (Read)	E_RD	t_{CCLR}	-	100	-	
Enable H pulse width (Read)		t_{CCHR}	-	100	-	
WRITE Data setup time	DB0 to DB7	t_{DS8}	-	150	-	
WRITE Address hold time		t_{DH8}	-	20	-	
READ access time		t_{ACC8}	$C_L=100pF$	-	40	
READ Output disable time		t_{OH8}	$C_L=100pF$	-	30	

Item	Signal	Symbol	Condition	Rating		Units
				Min	Max	
Address hold time	A0	t _{AH8}	-	20	-	ns
Address setup time		t _{AW8}	-	30	-	
System cycle time		t _{CYC8}	-	250	-	
Enable L pulse width (Write)	RW_WR	t _{CCLW}	-	150	-	
Enable H pulse width (Write)		t _{CCHW}	-	100	-	
Enable L pulse width (Read)	E_RD	t _{CCLR}	-	150	-	
Enable H pulse width (Read)		t _{CCHR}	-	100	-	
WRITE Data setup time	DB0 to DB7	t _{DS8}	-	200	-	
WRITE Address hold time		t _{DH8}	-	20	-	
READ access time		t _{ACC8}	C _L =100pF	-	40	
READ Output disable time		t _{OH8}	C _L =100pF	-	30	

- *1 The input signal rise time and fall time (tr, tf) is specified at 15 ns or less. When the system cycle time is extremely fast, $(t_r + t_f) \leq (t_{CYC8} - t_{CCLW} - t_{CCHW})$ for $(t_r + t_f) \leq (t_{CYC8} - t_{CCLR} - t_{CCHR})$ are specified.
- *2 All timing is specified using 20% and 80% of VDD as the reference.
- *3 t_{CCLW} and t_{CCLR} are specified as the overlap between XCS being “L” and WR and RD being at the “L” level.

For the 6800 Series MPU

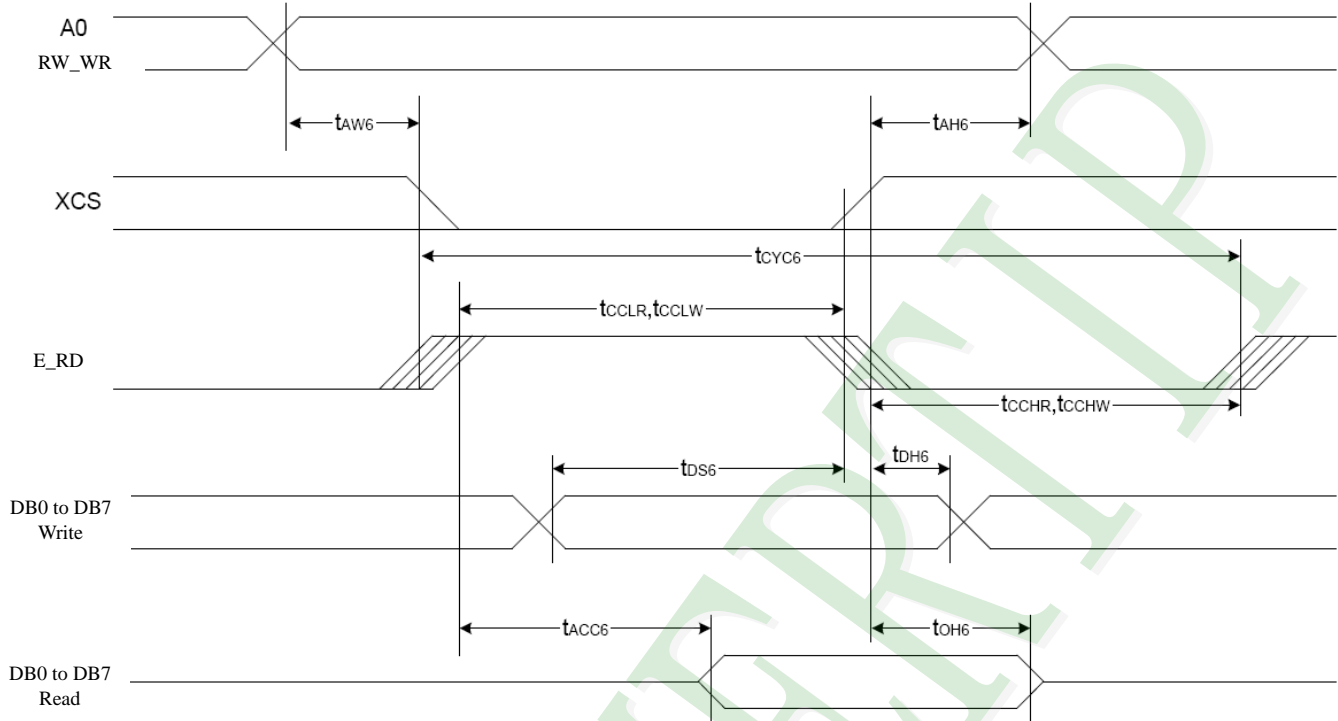

$V_{DD}=3.3V$

Item	Signal	Symbol	Condition	Rating		Units
				Min	Max	
Address hold time	A0	t_{AH6}	-	20	-	ns
Address setup time		t_{AW6}	-	20	-	
System cycle time		t_{CYC6}	-	200	-	
Enable L pulse width (Write)	RW_WR	t_{EQLW}	-	100	-	
Enable H pulse width (Write)		t_{EQLH}	-	100	-	
Enable L pulse width (Read)	E_RD	t_{EQLR}	-	100	-	
Enable H pulse width (Read)		t_{EQLR}	-	100	-	
WRITE Data setup time	DB0 to DB7	t_{DS6}	-	150	-	
WRITE Address hold time		t_{DH6}	-	20	-	
READ access time		t_{ACC6}	$C_L=100pF$	-	40	
READ Output disable time		t_{OH6}	$C_L=100pF$	-	30	

Item	Signal	Symbol	Condition	Rating		Units
				Min	Max	
Address hold time	A0	t_{AH6}	-	20	-	ns
Address setup time		t_{AW6}	-	30	-	
System cycle time		t_{CYC6}	-	250	-	
Enable L pulse width (Write)	RW_WR	t_{EWLW}	-	150	-	
Enable H pulse width (Write)		t_{EWHW}	-	100	-	
Enable L pulse width (Read)	E_RD	t_{EWLR}	-	150	-	
Enable H pulse width (Read)		t_{EWHR}	-	100	-	
WRITE Data setup time	DB0 to DB7	t_{DS6}	-	200	-	
WRITE Address hold time		t_{DH6}	-	20	-	
READ access time		t_{ACC6}	$C_L=100pF$	-	40	
READ Output disable time		t_{OH6}	$C_L=100pF$	-	30	

*1 The input signal rise time and fall time (t_r , t_f) is specified at 15 ns or less. When the system cycle time is extremely fast, $(t_r + t_f) \leq (t_{CYC6} - t_{EWLW} - t_{EWHW})$ for $(t_r + t_f) \leq (t_{CYC6} - t_{EWLR} - t_{EWHR})$ are specified.

*2 All timing is specified using 20% and 80% of VDD as the reference.

*3 t_{EWLW} and t_{EWLR} are specified as the overlap between XCS being “L” and E.

Reset Timing

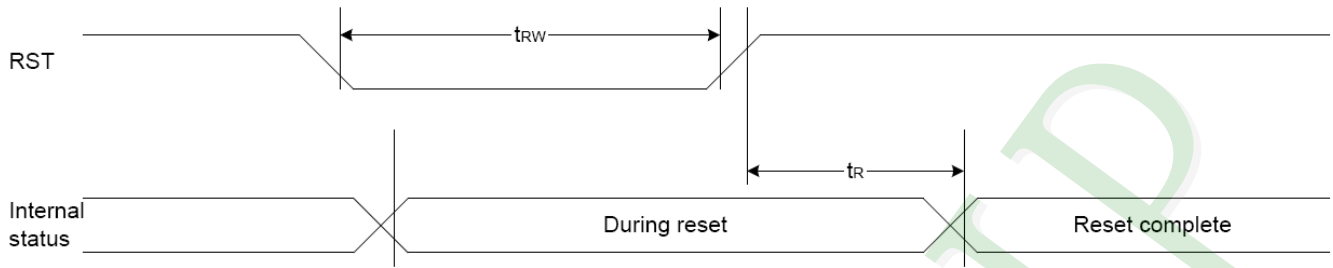
 $V_{DD} = 3.3V$

Item	Signal	Symbol	Condition	Rating			Units
				Min	Typ	Max	
Reset time	-	t_R	-	-	-	1	μs
Reset "L" pulse width	RST	t_{RW}	-	1	-	-	μs

 $V_{DD} = 2.7V$

Item	Signal	Symbol	Condition	Rating			Units
				Min	Typ	Max	
Reset time	-	t_R	-	-	-	1.5	μs
Reset "L" pulse width	RST	t_{RW}	-	1.5	-	-	μs

2.4 Display Command

Ext=0 or Ext=1

Index	Command	A0	RD	WR	D7	D6	D5	D4	D3	D2	D1	D0	Function	Hex	Parameter
1	Ext In	0	1	0	0	0	1	1	0	0	0	0	Ext=0 Set	30	None
2	Ext Out	0	1	0	0	0	1	1	0	0	0	1	Ext=1 Set	31	None

Ext=0

Index	Command	A0	RD	WR	D7	D6	D5	D4	D3	D2	D1	D0	Function	Hex	Parameter
1	DISON	0	1	0	1	0	1	0	1	1	1	1	Display On	AF	None
2	DISOFF	0	1	0	1	0	1	0	1	1	1	0	Display Off	AE	None
3	DISNOR	0	1	0	1	0	1	0	0	1	1	0	Normal Display	A6	None
4	DISINV	0	1	0	1	0	1	0	0	1	1	1	Inverse Display	A7	None
5	COMSCN	0	1	0	1	0	1	1	1	0	1	1	COM Scan Direction	BB	1 byte
6	DISCTRL	0	1	0	1	1	0	0	1	0	1	0	Display Control	CA	3 bytes
7	SLPIN	0	1	0	1	0	0	1	0	1	0	1	Sleep In	95	None
8	SLPOUT	0	1	0	1	0	0	1	0	1	0	0	Sleep Out	94	None
9	LASET	0	1	0	0	1	1	1	0	1	0	1	Line Address Set	75	2 bytes
10	CASET	0	1	0	0	0	0	1	0	1	0	1	Column Address Set	15	2 bytes
11	DATSDR	0	1	0	1	0	1	1	1	1	0	0	Data Scan Direction	BC	3 bytes
12	RAMWR	0	1	0	0	1	0	1	1	1	0	0	Writing to Memory	5C	Data
13	RAMRD	0	1	0	0	1	0	1	1	1	0	1	Reading from Memory	5D	Data
14	PTLIN	0	1	0	1	0	1	0	1	0	0	0	Partial display in	A8	2 bytes
15	PTLOUT	0	1	0	1	0	1	0	1	0	0	1	Partial display out	A9	None
16	RMWIN	0	1	0	1	1	1	0	0	0	0	0	Read and Modify Write	E0	None
17	RMWOUT	0	1	0	1	1	1	0	1	1	1	0	RMW end	EE	None
18	ASCSET	0	1	0	1	0	1	0	1	0	1	0	Area Scroll Set	AA	4 bytes
19	SCSTART	0	1	0	1	0	1	0	1	0	1	1	Scroll Start Set	AB	1 byte
20	OSCON	0	1	0	1	1	0	1	0	0	0	1	Internal OSC on	D1	None
21	OSCOFF	0	1	0	1	1	0	1	0	0	1	0	Internal OSC off	D2	None
22	PWRCTRL	0	1	0	0	0	1	0	0	0	0	0	Power Control	20	1 byte
23	VOLCTRL	0	1	0	1	0	0	0	0	0	0	1	EC control	81	2 bytes
24	VOLUP	0	1	0	1	1	0	1	0	1	1	0	EC increase 1	D6	None
25	VOLDOWN	0	1	0	1	1	0	1	0	1	1	1	EC decrease 1	D7	None
26	RESERVED	0	1	0	1	0	0	0	0	0	1	0	Not Use	82	0
27	EPSRRD1	0	1	0	0	1	1	1	1	1	0	0	READ Register1	7C	None

28	EPSRRD2	0	1	0	0	1	1	1	1	1	0	1	READ Register2	7D	None
29	NOP	0	1	0	0	0	1	0	0	1	0	1	NOP Instruction	25	None
30	STREAD	0	0	1	Read Data							Status Read			
31	EPINT	0	1	0	0	0	0	0	0	1	1	1	Initial code(1)	07	1 byte

Ext=1

<i>Index</i>	<i>Command</i>	<i>A0</i>	<i>RD</i>	<i>WR</i>	<i>D7</i>	<i>D6</i>	<i>D5</i>	<i>D4</i>	<i>D3</i>	<i>D2</i>	<i>D1</i>	<i>D0</i>	<i>Function</i>	<i>Hex</i>	<i>Parameter</i>
1	Gray 1 Set	0	1	0	0	0	1	0	0	0	0	0	FRAME 1 Gray PWM Set	20	16 bytes
2	Gray 2 Set	0	1	0	0	0	1	0	0	0	0	1	FRAME 2 Gray PWM Set	21	16 bytes
3	Wt. Set	0	1	0	0	0	1	0	0	0	1	0	Weight Set	22	3 bytes
4	ANASET	0	1	0	0	0	1	1	0	0	1	0	Analog Circuit Set	32	3 bytes
5	DITHOFF	0	1	0	0	0	1	1	0	1	0	0	Dithering Circuit Off	34	None
6	DITHON	0	1	0	0	0	1	1	0	1	0	1	Dithering Circuit On	35	None
7	EPCTIN	0	1	0	1	1	0	0	1	1	0	1	Control EEPROM	CD	1 byte
8	EPCOUT	0	1	0	1	1	0	0	1	1	0	0	Cancel EEPROM	CC	None
9	EPMWR	0	1	0	1	1	1	1	1	1	0	0	Write to EEPROM	FC	None
10	EPMRD	0	1	0	1	1	1	1	1	1	0	1	Read from EEPROM	FD	None

3. QUALITY ASSURANCE SYSTEM

3.1 Quality Assurance Flow Chart

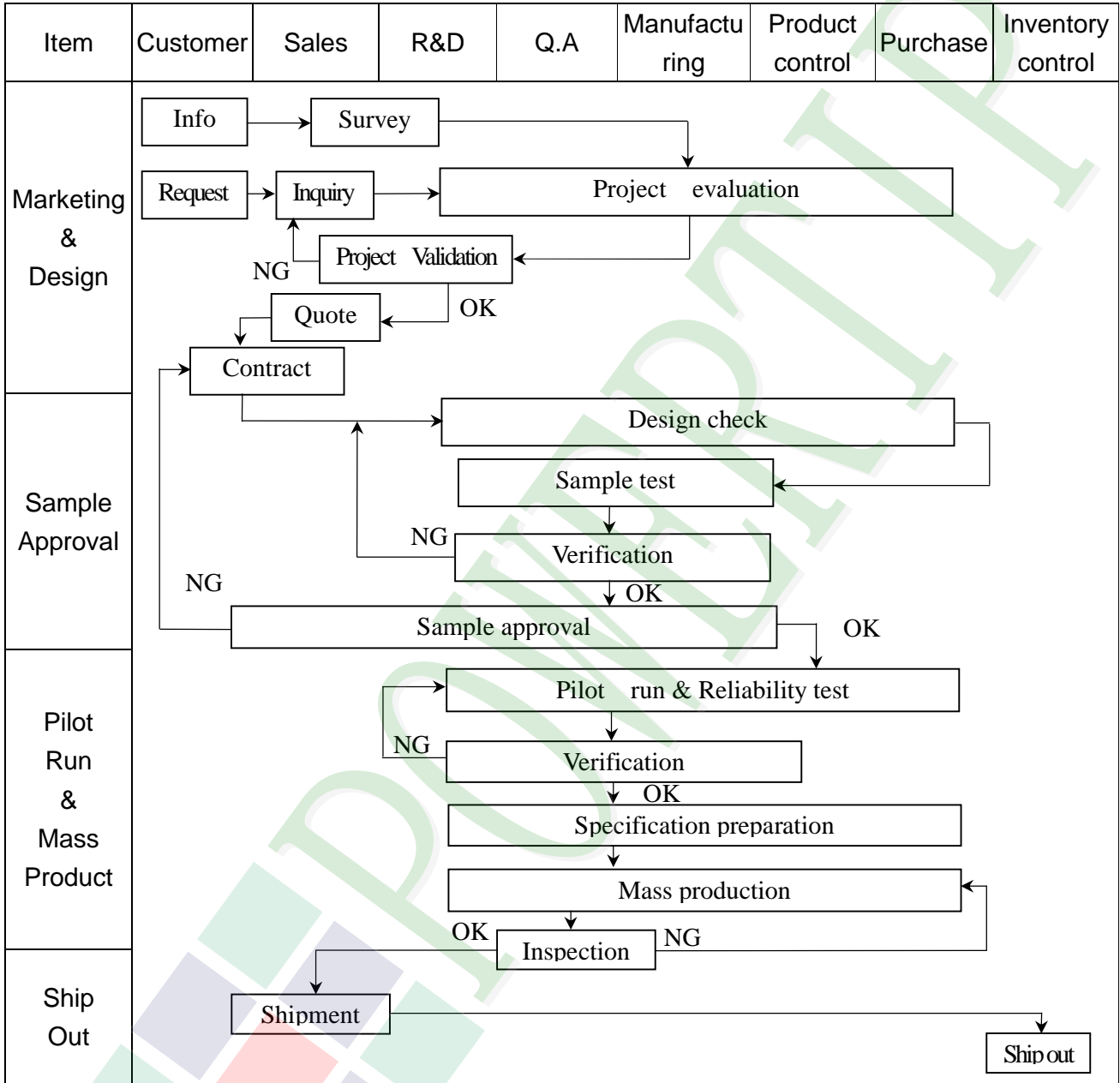

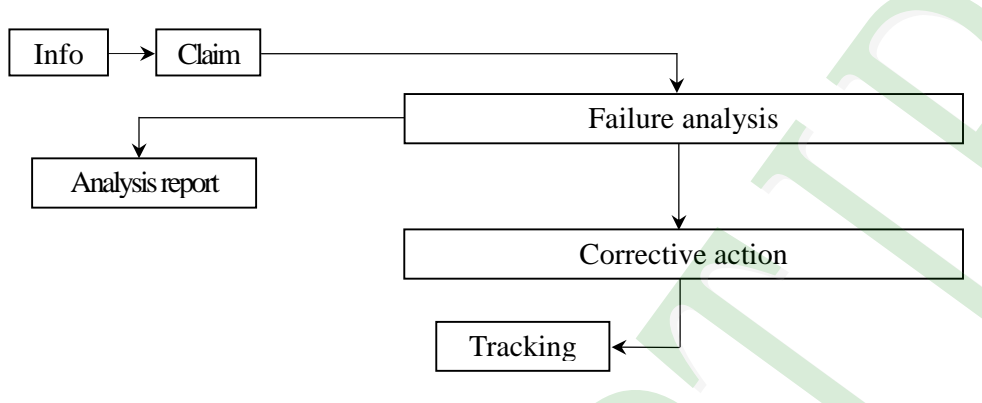
Item	Customer	Sales	R&D	Q.A	Manufacturing	Product control	Purchase	Inventory control
Sales Service	 <pre> graph TD Info[Info] --> Claim[Claim] Claim --> Failure[Failure analysis] Claim --> Report[Analysis report] Failure --> Action[Corrective action] Action --> Tracking[Tracking] </pre>							
Q.A Activity	1. ISO 9001 Maintenance Activities 3. Equipment calibration 5. Standardization Management				2. Process improvement proposal 4. Education And Training Activities			

3.2 Inspection Specification

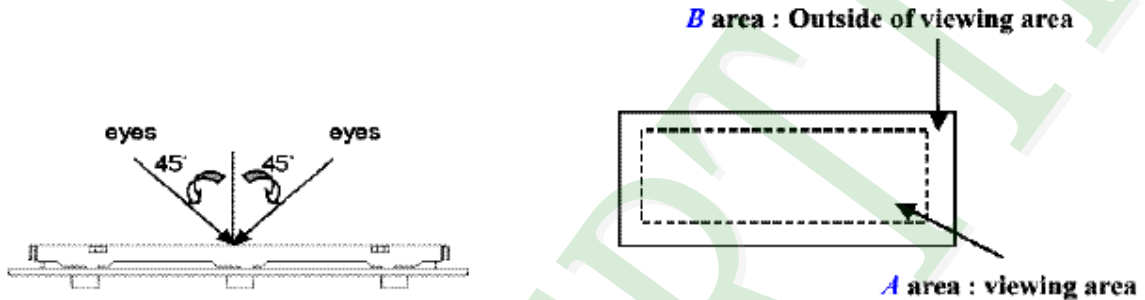

- ◆ Inspection Standard : MIL-STD-105E Table Normal Inspection Single Sampling Level II .
- ◆ Equipment : Gauge 、 MIL-STD 、 Powertip Tester 、 Sample
- ◆ Defect Level : Major Defect AQL 0.4; Minor Defect AQL 1.5 .
- ◆ OUT Going Defect Level : Sampling .
- ◆ Manner of appearance test :
 - (1). The test be under 40W×2 fluorescent light ' and distance of view must be at 30 cm.
 - (2). The test direction is base on about around 45° of vertical line. (Fig. 1)
 - (3). Definition of area . (Fig. 2)



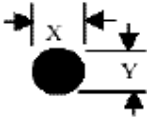
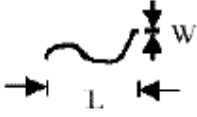

◆ Specification:

NO	Item	Criterion	level
01	Product condition	1.1 The part number is inconsistent with work order of Production.	Major
		1.2 Mixed production types.	Major
		1.3 Assembled in inverse direction.	Major
02	Quantity	2.1 The quantity is inconsistent with work order of production.	Major
03	Outline dimension	3.1 Product dimension and structure must conform to Structure diagram.	Major
04	Electrical Testing	4.1 Missing line character 、 dot and icon.	Major
		4.2 No function or no display.	Major
		4.3 Output data is error.	Major
		4.4 LCD viewing angle defect.	Major
		4.5 Current consumption exceeds product specifications.	Major
05	Black or white dot 、 scratch 、 contamination Round type	5.1 Round type: 5.1.1 display only : <ul style="list-style-type: none"> • White and black spots on display $\leq 0.30\text{mm}$, no more than Four white or black spots present. • Densely spaced : NO more than two spots or lines within 3mm 	Minor

◆Specification :

NO	Item	Criterion	level																																	
05	Black or white dot、scratch、contamination Round type  $\Phi=(x+y)/2$ 	5.1.2 Nom-display : <table border="1" data-bbox="552 367 1315 567"> <thead> <tr> <th>Dimension (diameter : Φ)</th> <th>Acceptance(Q'ty)</th> </tr> </thead> <tbody> <tr> <td>$\Phi \leq 0.10\text{mm}$</td> <td>Accept no dense</td> </tr> <tr> <td>$0.10\text{mm} < \Phi \leq 0.20\text{mm}$</td> <td>3</td> </tr> <tr> <td>$0.20\text{mm} < \Phi \leq 0.30\text{mm}$</td> <td>2</td> </tr> <tr> <td>Total</td> <td>4</td> </tr> </tbody> </table> 5.1.3 Line type: <table border="1" data-bbox="462 630 1380 871"> <thead> <tr> <th colspan="2">Dimension (diameter : Φ)</th> <th colspan="2">Acceptance (Q'ty)</th> </tr> <tr> <th>Length</th> <th>width</th> <th>A area</th> <th>B area</th> </tr> </thead> <tbody> <tr> <td>---</td> <td>$w \leq 0.03\text{mm}$</td> <td>Accept no dense</td> <td>Don't count</td> </tr> <tr> <td>$L \leq 3.0\text{mm}$</td> <td>$0.03\text{mm} < \Phi \leq 0.05\text{mm}$</td> <td rowspan="2">4</td> <td>Don't count</td> </tr> <tr> <td>$L \leq 2.5\text{mm}$</td> <td>$0.05\text{mm} < \Phi \leq 0.075\text{mm}$</td> <td>Don't count</td> </tr> <tr> <td>---</td> <td>$w > 0.075\text{mm}$</td> <td colspan="2">As round type</td> </tr> </tbody> </table>	Dimension (diameter : Φ)	Acceptance(Q'ty)	$\Phi \leq 0.10\text{mm}$	Accept no dense	$0.10\text{mm} < \Phi \leq 0.20\text{mm}$	3	$0.20\text{mm} < \Phi \leq 0.30\text{mm}$	2	Total	4	Dimension (diameter : Φ)		Acceptance (Q'ty)		Length	width	A area	B area	---	$w \leq 0.03\text{mm}$	Accept no dense	Don't count	$L \leq 3.0\text{mm}$	$0.03\text{mm} < \Phi \leq 0.05\text{mm}$	4	Don't count	$L \leq 2.5\text{mm}$	$0.05\text{mm} < \Phi \leq 0.075\text{mm}$	Don't count	---	$w > 0.075\text{mm}$	As round type		Minor
Dimension (diameter : Φ)	Acceptance(Q'ty)																																			
$\Phi \leq 0.10\text{mm}$	Accept no dense																																			
$0.10\text{mm} < \Phi \leq 0.20\text{mm}$	3																																			
$0.20\text{mm} < \Phi \leq 0.30\text{mm}$	2																																			
Total	4																																			
Dimension (diameter : Φ)		Acceptance (Q'ty)																																		
Length	width	A area	B area																																	
---	$w \leq 0.03\text{mm}$	Accept no dense	Don't count																																	
$L \leq 3.0\text{mm}$	$0.03\text{mm} < \Phi \leq 0.05\text{mm}$	4	Don't count																																	
$L \leq 2.5\text{mm}$	$0.05\text{mm} < \Phi \leq 0.075\text{mm}$		Don't count																																	
---	$w > 0.075\text{mm}$	As round type																																		
06	Polarizer Bubble	<table border="1" data-bbox="462 955 1372 1270"> <thead> <tr> <th rowspan="2">Dimension (diameter : Φ)</th> <th colspan="2">Acceptance(Q'ty)</th> </tr> <tr> <th>A area</th> <th>B area</th> </tr> </thead> <tbody> <tr> <td>$\Phi \leq 0.20\text{mm}$</td> <td>Accept no dense</td> <td>Don't count</td> </tr> <tr> <td>$0.20\text{mm} < \Phi \leq 0.50\text{mm}$</td> <td>3</td> <td>Don't count</td> </tr> <tr> <td>$0.50\text{mm} < \Phi \leq 1.00\text{mm}$</td> <td>2</td> <td>Don't count</td> </tr> <tr> <td>$\Phi > 1.00\text{mm}$</td> <td>0</td> <td>Don't count</td> </tr> <tr> <td>Total quantity</td> <td>4</td> <td>Don't count</td> </tr> </tbody> </table>	Dimension (diameter : Φ)	Acceptance(Q'ty)		A area	B area	$\Phi \leq 0.20\text{mm}$	Accept no dense	Don't count	$0.20\text{mm} < \Phi \leq 0.50\text{mm}$	3	Don't count	$0.50\text{mm} < \Phi \leq 1.00\text{mm}$	2	Don't count	$\Phi > 1.00\text{mm}$	0	Don't count	Total quantity	4	Don't count	Minor													
Dimension (diameter : Φ)	Acceptance(Q'ty)																																			
	A area	B area																																		
$\Phi \leq 0.20\text{mm}$	Accept no dense	Don't count																																		
$0.20\text{mm} < \Phi \leq 0.50\text{mm}$	3	Don't count																																		
$0.50\text{mm} < \Phi \leq 1.00\text{mm}$	2	Don't count																																		
$\Phi > 1.00\text{mm}$	0	Don't count																																		
Total quantity	4	Don't count																																		
07	The crack of glass 	● Glass Crack: 7.1 Crack on the circuit of electrode terminal : <table border="1" data-bbox="527 1617 1315 1764"> <thead> <tr> <th></th> <th>X</th> <th>Y</th> <th>Z</th> </tr> </thead> <tbody> <tr> <td>Front</td> <td>$X \leq 1/5 a$</td> <td>$Y \leq 1/2 D$</td> <td>$Z \leq t$</td> </tr> <tr> <td>Back</td> <td colspan="3">Neglect</td> </tr> </tbody> </table>		X	Y	Z	Front	$X \leq 1/5 a$	$Y \leq 1/2 D$	$Z \leq t$	Back	Neglect			Minor																					
	X	Y	Z																																	
Front	$X \leq 1/5 a$	$Y \leq 1/2 D$	$Z \leq t$																																	
Back	Neglect																																			

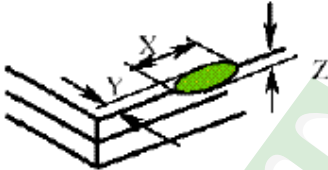
◆Specification :

NO	Item	Criterion	Level												
07	<p>The crack of glass</p> <p>X: The length of Crack</p> <p>Y: The width of crack</p> <p>Z: The thickness of crack</p> <p>D: terminal length</p> <p>T: The thickness of glass</p> <p>A : The length of glass</p>	<p>● Glass Crack:</p> <p>7.2 General glass crack and corner edge:</p> <p>7.2.1</p>  <table border="1" data-bbox="583 705 1255 800"> <tr> <td>X</td> <td>Y</td> <td>Z</td> </tr> <tr> <td>Neglect</td> <td>Out A area</td> <td>Neglect</td> </tr> </table> <p>7.2.2</p>  <table border="1" data-bbox="583 1056 1255 1150"> <tr> <td>X</td> <td>Y</td> <td>Z</td> </tr> <tr> <td>Neglect</td> <td>Out A area</td> <td>Neglect</td> </tr> </table>	X	Y	Z	Neglect	Out A area	Neglect	X	Y	Z	Neglect	Out A area	Neglect	Minor
X	Y	Z													
Neglect	Out A area	Neglect													
X	Y	Z													
Neglect	Out A area	Neglect													
		<p>7.3 Glass remain:</p>  <table border="1" data-bbox="722 1598 1146 1692"> <tr> <td>X</td> <td>Y</td> </tr> <tr> <td>Neglect</td> <td>$\leq 1/3 d$</td> </tr> </table>	X	Y	Neglect	$\leq 1/3 d$	Minor								
X	Y														
Neglect	$\leq 1/3 d$														

◆Specification :

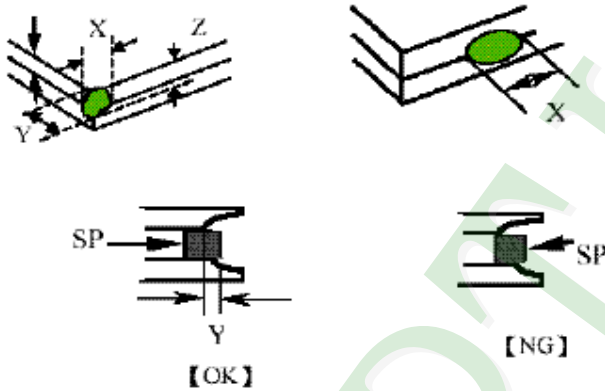
NO	Item	Criterion	Level									
07	<p>The crack of glass</p> <p>X: The length of Crack</p> <p>Y: The width of crack</p> <p>Z: The thickness of crack</p> <p>D: terminal length</p> <p>T: The thickness of glass</p> <p>A : The length of glass</p>	<p>7.4 Corner crack and medial crack:</p>  <table border="1" data-bbox="483 892 1369 1077"> <thead> <tr> <th>X</th> <th>Y</th> <th>Z</th> </tr> </thead> <tbody> <tr> <td>$\leq 1/5a$</td> <td>Crack can't enter viewing area</td> <td>$\leq 1/2t$</td> </tr> <tr> <td>$\leq 1/5a$</td> <td>Crack can't exceed the half of width of SP</td> <td>$1/2t < Z \leq 2t$</td> </tr> </tbody> </table>	X	Y	Z	$\leq 1/5a$	Crack can't enter viewing area	$\leq 1/2t$	$\leq 1/5a$	Crack can't exceed the half of width of SP	$1/2t < Z \leq 2t$	Minor
X	Y	Z										
$\leq 1/5a$	Crack can't enter viewing area	$\leq 1/2t$										
$\leq 1/5a$	Crack can't exceed the half of width of SP	$1/2t < Z \leq 2t$										
08	Backlight elements	<p>8.1 Backlight can't work normally.</p> <p>8.2 Backlight doesn't light or color is wrong.</p> <p>8.3 Illumination source flickers when lit.</p>	Major									
09	General appearance	<p>9.1 pin type must match type in specification sheet</p> <p>9.2 No short circuits in components on PCB or FPC</p> <p>9.3 Product packaging must the same as specified on packaging specification sheet.</p> <p>9.4 The folding and peeled off in polarizer are not acceptable</p> <p>9.5 The PCB or FPC between B/L assembled distance (PCB or FPC) is $\leq 1.5\text{mm}$</p>	Major									

4. RELIABILITY TEST

4.1 Reliability Test Condition

NO.	TEST ITEM	TEST CONDITION											
1	High Temperature Storage Test	Keep in $80 \pm 2^{\circ}\text{C}$ 96 hrs Surrounding temperature, then storage at normal condition 4hrs											
2	Low Temperature Storage Test	Keep in $-30 \pm 2^{\circ}\text{C}$ 96 hrs Surrounding temperature, then storage at normal condition 4hrs											
3	High Humidity Storage	Keep in $+60^{\circ}\text{C}/90\%\text{RH}$ duration for 96 hrs Surrounding temperature, then storage at normal condition 4hrs (Excluding the polarizer)											
4	ESD Test	Air Discharge: Apply 2 KV with 5 times Discharge for each polarity +/-	Contact Discharge: Apply 250V with 5 times discharge for each polarity +/-										
		1. Temperature Ambient: $15^{\circ}\text{C} \sim 35^{\circ}\text{C}$ 2. Humidity relative: $30\% \sim 60\%$ 3. Energy Storage Capacitance(Cs+Cd): $150\text{pF} \pm 10\%$ 4. Discharge Resistance(Rd): $330\Omega \pm 10\%$ 5. Discharge, mode of operation: Single Discharge (time between successive discharges at least 1 s) (Tolerance If the output voltage indication: $\pm 5\%$)											
5	Temperature Cycling Test	$-20^{\circ}\text{C} \rightarrow 25^{\circ}\text{C} \rightarrow 70^{\circ}\text{C} \rightarrow 25^{\circ}\text{C}$ $(30\text{mins}) (5\text{mins}) (30\text{mins}) (5\text{mins})$  Surrounding temperature, then storage at normal condition 4hrs											
6	Vibration Test (Packaged)	1. Sine wave $10 \sim 55\text{HZ}$ frequency (1 min) 2. The amplitude of vibration :1.5 mm 3. Each direction (XYZ) duration for 2 Hrs											
7	Drop Test (Packaged)	<table border="1"> <thead> <tr> <th>Packing Weight (Kg)</th> <th>Drop Height (cm)</th> </tr> </thead> <tbody> <tr> <td>0 ~ 45.4</td> <td>122</td> </tr> <tr> <td>45.4 ~ 90.8</td> <td>76</td> </tr> <tr> <td>90.8 ~ 454</td> <td>61</td> </tr> <tr> <td>Over 454</td> <td>46</td> </tr> </tbody> </table>	Packing Weight (Kg)	Drop Height (cm)	0 ~ 45.4	122	45.4 ~ 90.8	76	90.8 ~ 454	61	Over 454	46	
		Packing Weight (Kg)	Drop Height (cm)										
0 ~ 45.4	122												
45.4 ~ 90.8	76												
90.8 ~ 454	61												
Over 454	46												
		Drop direction : ※3 comer /1 edges /6 sides etch 1times											

5. PRECAUTION RELATING PRODUCT HANDLING

5.1 SAFETY

- 5.1.1 If the LCD panel breaks , be careful not to get the liquid crystal to touch your skin.
- 5.1.2 If the liquid crystal touches your skin or clothes , please wash it off immediately by using soap and water.

5.2 HANDLING

- 5.2.1 Avoid any strong mechanical shock which can break the glass.
- 5.2.2 Avoid static electricity which can damage the CMOS LSI—When working with the module , be sure to ground your body and any electrical equipment you may be using.
- 5.2.3 Do not remove the panel or frame from the module.
- 5.2.4 The polarizing plate of the display is very fragile. So , please handle it very carefully ,do not touch , push or rub the exposed polarizing with anything harder than an HB pencil lead (glass , tweezers , etc.)
- 5.2.5 Do not wipe the polarizing plate with a dry cloth , as it may easily scratch the surface of plate.
- 5.2.6 Do not touch the display area with bare hands , this will stain the display area.
- 5.2.7 Do not use ketonics solvent & aromatic solvent. Use with a soft cloth soaked with a cleaning naphtha solvent.
- 5.2.8 To control temperature and time of soldering is $320\pm 10^{\circ}\text{C}$ and 3-5 sec.
- 5.2.9 To avoid liquid (include organic solvent) stained on LCM .

5.3 STORAGE

- 5.3.1 Store the panel or module in a dark place where the temperature is $25^{\circ}\text{C} \pm 5^{\circ}\text{C}$ and the humidity is below 65% RH.
- 5.3.2 Do not place the module near organics solvents or corrosive gases.
- 5.3.3 Do not crush , shake , or jolt the module.

5.4 TERMS OF WARRANTY

- 5.4.1 Applicable warrant period
The period is within thirteen months since the date of shipping out under normal using and storage conditions.
- 5.4.2 Unaccepted responsibility
This product has been manufactured to your company's specification as a part for use in your company's general electronic products. It is guaranteed to perform according to delivery specifications. For any other use apart from general electronic equipment , we cannot take responsibility if the product is used in nuclear power control equipment , aerospace equipment , fire and security systems or any other applications in which there is a direct risk to human life and where extremely high levels of reliability are required.

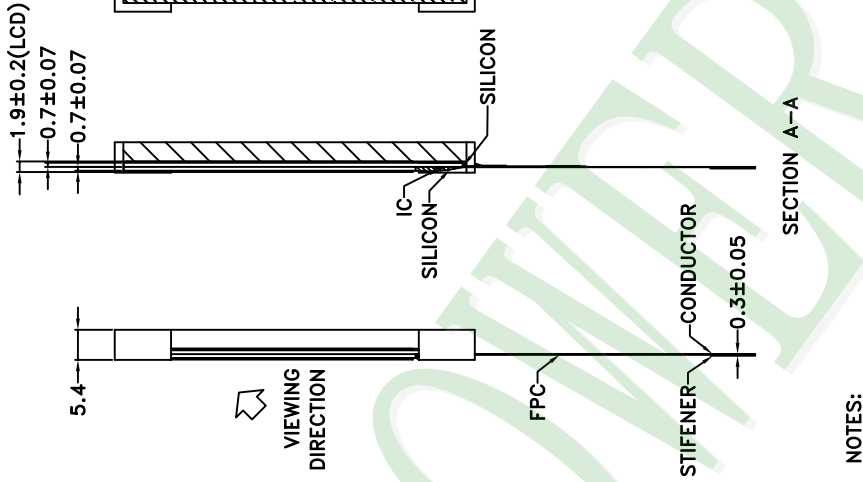
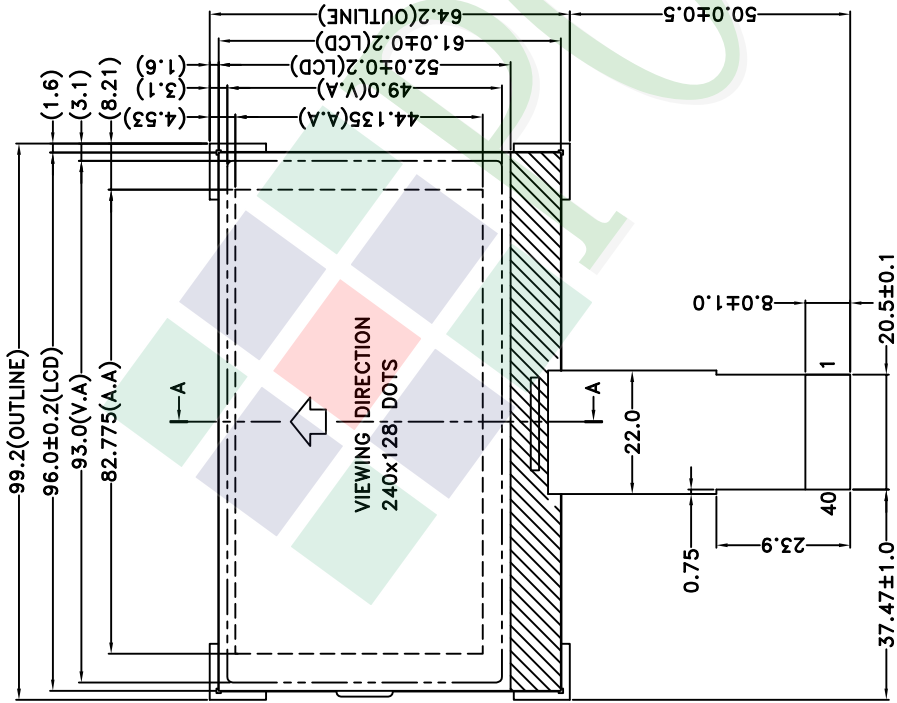

SECTION A-A

- NOTES:
1. LCD TYPE: FSTN
 2. LCD DISPLAY: POSITIVE / TRANSPARENT
 3. VIEW DIRECTION: 6 O'CLOCK
 4. TOP: -20~70°C TST: -30~80°C
 5. B=PO.5x39=19.5±0.05, W=0.25±0.05
 6. IC NO.: ST7529
 7. THE TOLERANCE UNLESS CLASSIFIED ±0.3MM
 8. THIS PRODUCT CONFORMS ROHS

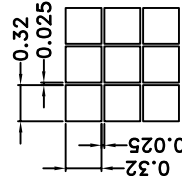

DOTS DETAIL
SCALE: 20/1

久正光電股份有限公司
POWER TIP TECHNOLOGY CORPORATION

圖面名稱	圖面編號	SCALE: NOTE	UNIT: mm	PAGE: 1/1	APPROVED	CHECKER	DRAWN
PE240128WRF001HC1Q	DMD-08200				周自立	邵小孟	彭武輪
REV	DESCRIPTION	DATE	EDI	001			

LCM Model	PE240128WRF001HC1Q
Drawing NO	DPK-08343

LCM包裝規格書

LCM Packaging Specifications

(For Tray)

Approve	Check	Contact
周自立	邵小孟	彭武輪
DATE	初版	版次Ver
08.06.27	08.06.27	001

1. 包裝材料規格表 (Packaging Material) : (per carton)

No.	Item	Model	Dimensions (mm)	Quantity
1	成品 (LCM)	PE240128WRF001HC1Q	99.2X64.2X5.4	180
2	多層薄膜(1)POF	OTFILM0BA03ABA	19"X350X0.015	6
3	TRAY 盤 (2)	TYPG24012801BA	352 X 260 X 13	36
4	內盒(3)Product Box	BX36627063ABBA	383 X 270X 66	6
5	保力龍板(4)Polylon board	OTPLB00PL08ABA	550 X 393 X 20	2
6	外紙箱(5)Carton	BX57041027CCBA	570 X 410 X 265	1
7				
8				
9				

2. 單箱數量規格表 (Packaging Specifications and Quantity) :

(1) LCM quantity per box : no per tray	6	x no per tray	5	=	30
(2) Total LCM quantity in carton : quantity per box	30	x no of boxes	6	=	180

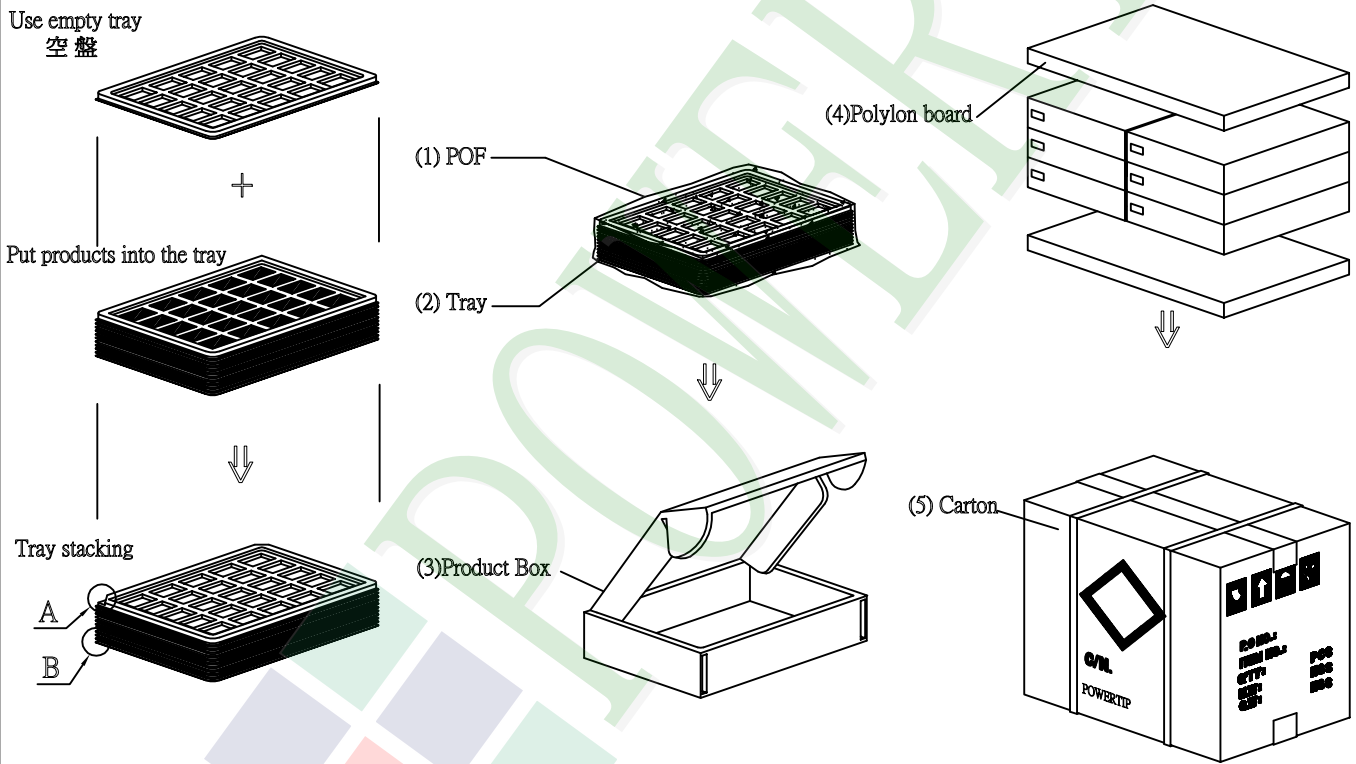

特記事項 (REMARK)

1. Label Specifications :

MODEL:
LOT NO:
QUANTITY:
CHECK:

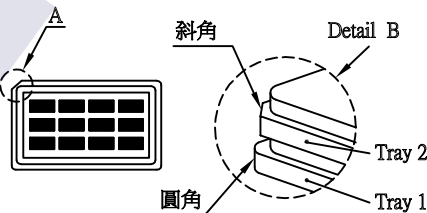

2. Rotate tray 180 degrees and place on top of stack.
Check the tray stack using Fig. B.
TRAY盤相疊時,需旋轉180度,請詳見B視圖

3. It's also suitable to Panel
(可適用於單品包裝)

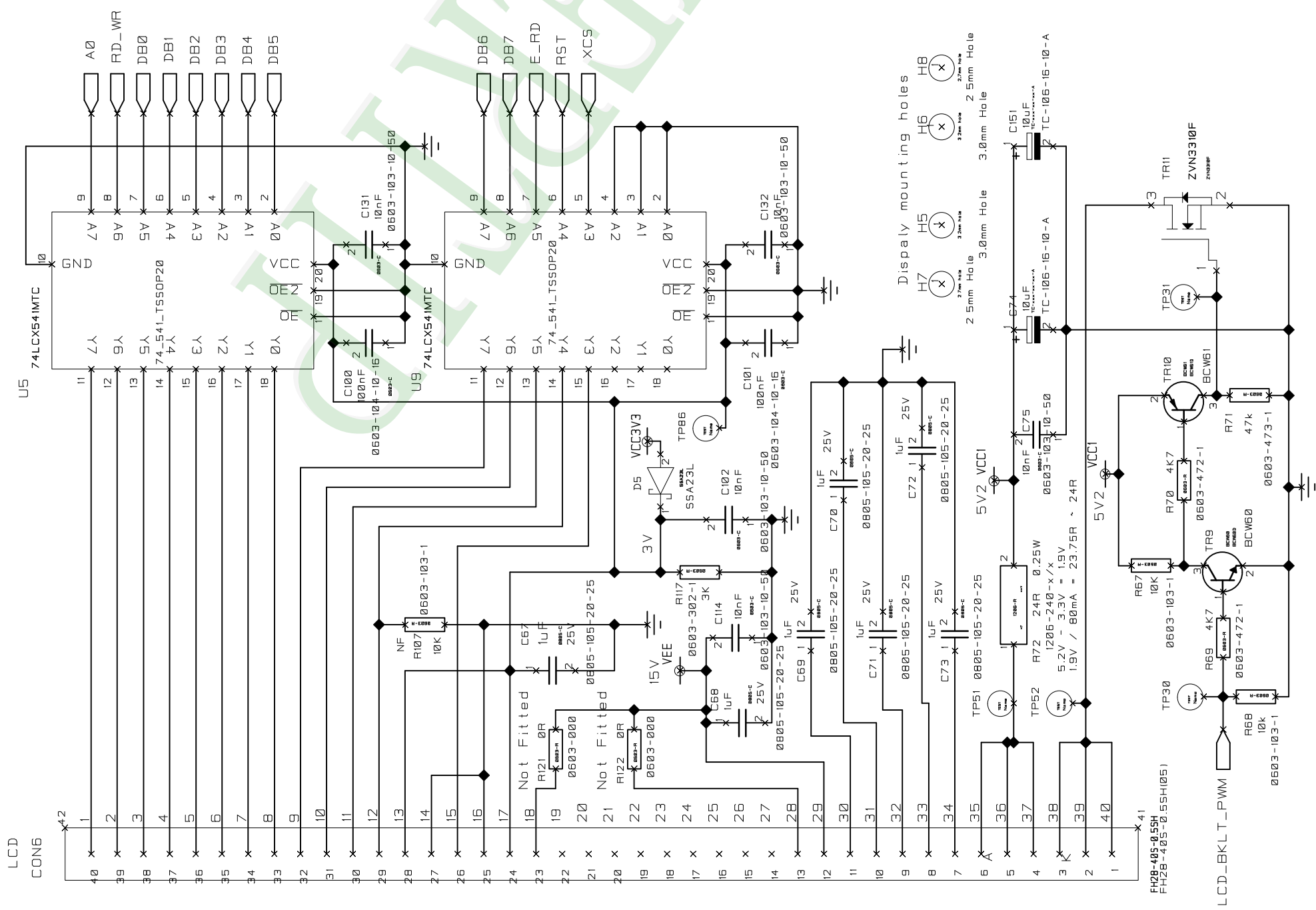

REMOVE ALL BURRS AND SHARP EDGES.
TOLERANCE ± 0.5 , X.X ϕ 3, X.XX ϕ .15
UNLESS OTHERWISE STATED.

MATERIAL		TITLE	
FINISH		LCD Level Shifter	
DRG No. AAABBB		SHT. NO. 10 f 1	
ISSUE	C.N.	DATE	SCALE
A	***	29.05.08	FS
DRAWN		CHKD.	

PORTMANMOOR RD. IND. EST., CARDIFF. TEL. 0291 2048585
HUNBLEIGH TECHNOLOGY PLC 2001. ALL RIGHTS RESERVED. NO PART OF
THIS DRAWING MAY BE REPRODUCED, STORED ON A RETRIEVAL SYSTEM, TRANSMITTED IN ANY FORM OR BY ANY
MEANS ELECTRONIC, MECHANICAL, PHOTOCOPYING OR OTHERWISE WITHOUT PRIOR PERMISSION OF THE COPYRIGHT OWNER.

```

// ST7529 240x128 LCD
// initial ST7529
LCD_Write_Com(0x30); // EXT=0
LCD_Write_Com(0xD1); // INTERNAL OSCILLATION ON

LCD_Write_Com(0x94); // SLEEP OUT

LCD_Write_Com(0xCA); // DISPLAY CONTROL(CL,DUTY,FR)
LCD_Write_Data(0x00); // CL DIVIDING RATIO(CLD=0)
LCD_Write_Data(0x27); // DRIVE DUTY(1/160 = 160/4 -1=39)
LCD_Write_Data(0x00); // FR INVERSE-SET VALUE
LCD_Write_Com(0xBB); // COMMON SCAN DIRECTON
LCD_Write_Data(0x01); // SET COM0->COM79,COM159->COM80

LCD_Write_Com(0x81); // ELECTRONIC VOLUME CONTROL
LCD_Write_Data(CONS50); // Vop=???.?V or SETTING VOLUME VALUE
LCD_Write_Data(CONS86); // SETTING BUILT-IN RESISTANCE VALUE
LCD_Write_Com(0x20); // POWER CONTROL SET
LCD_Write_Data(0x03); // Regulator, Follower ON, external 15V
LCD_Write_Com(0xA7); // Inverse Display
LCD_Write_Com(0xA9); // PARTIAL OUT

LCD_Write_Com(0xBC); // DATA SCAN DIRECTION
LCD_Write_Data(0x02); // NORMAL/INVERSE DISPLAY OF (THE LINE AND
// ADDRESS SCAN DIRECTION

LCD_Write_Data(0x01); // NOT USED,D0 MUST BE 0
LCD_Write_Data(0x02); // GRAY-SCALE SETUP(3B3P MODE) as per V1.6 on-line
//spec

LCD_Write_Com(0x75); // LINE ADDRESS SET
LCD_Write_Data(0x00); // START LINE SET 00
LCD_Write_Data(159); // END LINE SET 159

LCD_Write_Com(0x15); // COLUMN ADDRESS SET
LCD_Write_Data(5); // START COLUMN SET 00
LCD_Write_Data(0x54); // END COLUMN SET 255/3=85

LCD_Write_Com(0x31); // EXT=1 SET

```

```
LCD_Write_Com(0x32); // Analog circuit set
LCD_Write_Data(0x00); // OSC Frequency
LCD_Write_Data(0x01); // Booster Set
LCD_Write_Data(0x04); // Bias Set 1/10
LCD_Write_Com(0x34); // Software Initial / (Dithering OFF ?)
LCD_Write_Com(0x30); // EXT=0
LCD_Write_Com(0xAF); // DISPLAY ON
```

