

SUNCOM 新创电源	产品类型	LED 驱动电源 LED INTEGRATED SPECIAL DRIVER		
	产品系列	SCP-100-56X系列	REV	V3.1

广东新创电源科技有限公司

客户承认书

SPECIFICATION FOR APPROVAL

CUSTOMER/客户名:	
MODEL NO./产品型号:	SCP-100-56X系列
Rev./版本号	V3.1
SAMPLE DATE/送样日期:	

客户确认栏

TESTED BY 检查	CHECKED BY 审核	APPROVED BY 批准
客户备注		

Please return to us one copy of "SPECIFICATION FOR APPROVAL" with you approved signature./客户确认签章后请回传一份承认书给我公司.

新创确认栏

TESTED BY 检查	CHECKED BY 审核	APPROVED BY 批准

Guangdong SUNCOM Power Technology Co., Ltd.

广东新创电源科技有限公司

No. 1 of Yongyi 3rd Road Henglan Town Zhongshan Guangdong China Post code 528478

地址: 广东省中山市横栏镇永兴工业区永谊三路1号 邮编: 528478

TEL: 0760-22326609 28168136 FAX: 0760-87600929

SUNCOM 新创电源	产品类型	LED 驱动电源 LED INTEGRATED SPECIAL DRIVER		
	产品系列	SCP-100-56X系列	REV	V3.1

◆ Features 产品特性:

- Input Rated voltage : 100-277Vac 50Hz/60Hz
输入额定电压范围:100-277Vac 50Hz/60Hz
- Isolation, Constant current mode output
隔离, 恒流模式输出
- Surge Protection: L-N :6KV; L/N- E:10KV
防雷保护: 火线对零线6KV, 火线/零线对地10KV
- 3 in 1 dimming(dim-to-off) : PWM/0-10V/resistance
三合一调光(调光可关断, 隔离设计): PWM/0-10V/电阻
- AUX Power:12V/0.25A
辅组源: 12V/0.25A
- Over temperature drop current
过温降电流
- Output current is adjustable
输出电流可调
- Input under-voltage protection
输入欠压保护
- THD<15%



◆ Applications 产品应用:

Application: Street light、high bay lighting and other lighting lamps

应用于: 路灯、工矿灯等照明灯具

◆ Description 产品描述:

This product is a constant current drive power supply, Specially designed for LED, With low harmonic (< 15%), High power factor. Output current can be flexibly adjusted according to the led lamp voltage. 3 in 1 dimming. Built-in Surge protection, Output Open-circuit、Short-circuit Protection,Input under-voltage protection, Greatly improve the safety and reliability of the product.

本产品为恒流驱动电源, 专为LED设计, 具有低谐波(<15%)、高功率因数。输出电流可根据LED灯电压灵活调节。三合一调光功能, 内置防雷保护, 输出开路、短路保护, 输入欠压保护, 极大的提高了产品的安全可靠性能。

SUNCOM 新创电源	产品类型	LED 驱动电源 LED INTEGRATED SPECIAL DRIVER		
	产品系列	SCP-100-56X系列	REV	V3.1

■ MODEL LIST 型号列表

Model 型号	Rated Power 额定输出功率	Input Voltage 输入电压	Output Voltage 输出电压范围	Output Current 输出电流	Default current 默认电流@42V	THD. (Typ)	PF. (Typ)
SCP-100-56X	100W	100-277Vac	28-56V	1.6A-3A	2.1A	10%	0.97

NOTE: All parameters NOT special mentioned are measured at 230Vac input, rated load and 25°C of ambient temperature ; 如未特殊注明, 所有参数均在 230Vac 输入、额定负载、25°C 环境温度下测量

■ “X” Means Additional Function 后缀“X”功能可选机型表

“X”	Time control (可调电流+默认6小时降 半功率: 后缀F)	ADJ Current (可调电流: 后缀A)	0-10V/PWM Dim/Resistor (三合一调光: 后缀B)	0-10V/PWM Dim/Resistor +AUX 12V (三合一调光+辅组源: 后缀C)
B			√	

NOTE: When using the B/C version, it is recommended that the LED voltage is above 30V to prevent the dimming shutdown from failing to turn off the LED ;

使用 B/C 版本时, 建议灯珠电压大于 30V, 防止调光关断后 LED 不能调灭

■ ELECTRICAL SPECIFICATION 电气规格

◆ 输入性能 Input performance:

Parameter 参数	Min. 最小值	Typ. 典型值	Max. 最大值	Notes. 备注
Voltage Range 电压范围	90Vac	100-277Vac	305Vac	-
Frequency Range 频率范围	47Hz	50/60Hz	63Hz	-
AC Current 交流电流	-	-	1.4A	-
Inrush Current 浪涌电流	-	-	70A	At 230Vac input, 25°C cold start 环温 25°C, 230Vac 冷机启动
PF. 功率因数	0.95	0.97	-	At 230Vac input, full load 满载, 输入 230Vac 下测量
THD. 总谐波失真	-	10%	15%	

SUNCOM 新创电源	产品类型	LED 驱动电源 LED INTEGRATED SPECIAL DRIVER		
	产品系列	SCP-100-56X系列	REV	V3.1

◆ 输出性能: Output performance

Parameter 参数	Min. 最小值	Typ. 典型值	Max. 最大值	Notes. 备注
Voltage Range 电压范围	28VDC	-	56VDC	-
Current range Regulation 电流调节范围(电位器)	1.6A	-	3.0A	-
Rated Power 额定功率	-	-	100W	Output Voltage > 33V
Over Voltage 空载电压	63V	-	70V	-
Efficiency 效率	≥90%	90.5%	-	Measured at full load and 230Vac input
Current Tolerance 电流精度	-5%	-	+5%	-
Line Regulation 线性调整率	-5%	-	+5%	-
Load Regulation 负载调整率	-3%	-	+3%	-
Current Ripple 纹波电流	-	±50%	<±55%	-
Turn-on Delay Time 启动时间	-	600mS	<1S	Measured at full load and 230Vac input
Short Circuit Protection 短路保护	-	-	2W	Hiccup mode, recovers automatically after fault condition is removed 打嗝模式, 故障排除后自动恢复
Over-temperature protection 过温保护	-	90°C	-	Shell Tc point temperature, Drop current mode, the current automatically recovers after over temperature release, 外壳TC点温度, 降电流模式, 过温解除后, 电流自动恢复
Under Voltage Protection 欠压保护	90Vac	95Vac	98Vac	After the input voltage is reduced to the under voltage point, Reduce output current by 50%, resume work after the AC voltage is normal 输入电压降低到欠压点后, 降低一半输出电流, 交流电压正常后恢复工作

■ 环境: Environment

Parameter 参数	Min. 最小值	Typ. 典型值	Max. 最大值	Notes. 备注
Working TEMP 工作温度	-40°C	+25°C	+60°C	-
Storage TEMP 储存温度	-40°C	+25°C	+85°C	-
Working Humidity 工作湿度	20% RH	-	90% RH	-
Storage Humidity 储存湿度	10% RH	-	90% RH	-
Maximum shell TEMP 最大壳温	-	-	+90°C	-

SUNCOM 新创电源	产品类型	LED 驱动电源 LED INTEGRATED SPECIAL DRIVER		
	产品系列	SCP-100-56X系列	REV	V3.1

■ 安规和电磁兼容:

Withstand voltage 耐压	I/P - FG:1.75KVAC, I/P-O/P:3.75KVAC, I/P-调光: 3.75KVAC, O/P-调光: 0.5KVAC
isolation resistance 绝缘阻抗	$\geq 10M\Omega$ at I/P - FG 500VDC Test
leakage current 漏电流	$< 0.75mA/277Vac$
Earthing resistance 接地电阻	$< 0.1\Omega$ / 25A 1 min
Surge 浪涌	差模 L-N +/- 6KV (2 ohm), 共模 L, N-E +/- 10KV (12 ohm)
conducted electromagnetic interference 传导	-
Radiated electromagnetic interference 辐射	-

NOTE:

- 1) All parameters NOT specially mentioned are measured at 230Vac (50Hz) input, rated load and 25°C of ambient temperature.
如未特别说明, 所有规格参数均在 230Vac (50Hz) 输入, 额定负载, 环境温度 25°C 的条件下进行测量
- 2) Tolerance : includes set up tolerance, line regulation and load regulation.
误差: 包含设定误差、线性调整率和负载调整率。

■ THD VS INPUT VOLTAGE THD VS 输入电压

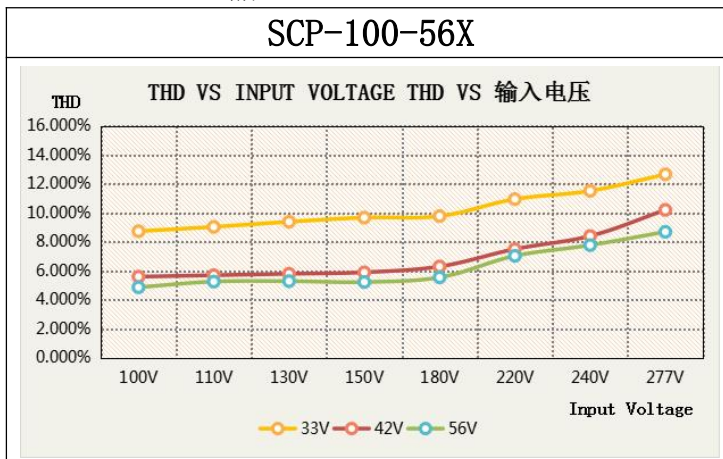

■ PF VS INPUT VOLTAGE PF 值 VS 输入电压

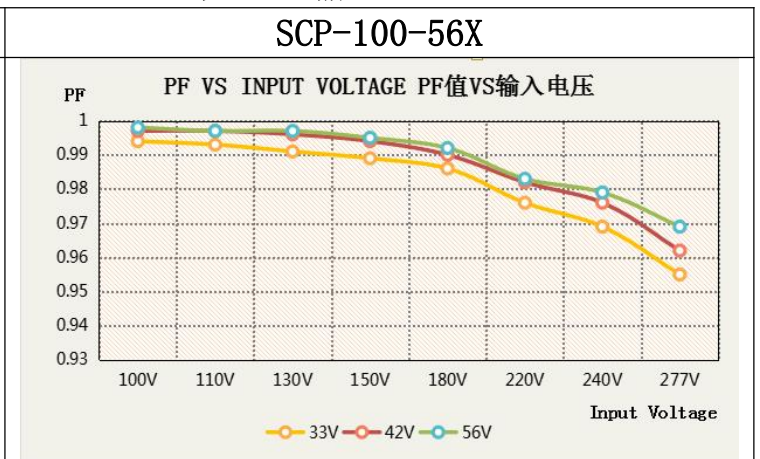

EFFICIENCY VS INPUT VOLTAGE

效率 VS 输入电压

SCP-100-56X

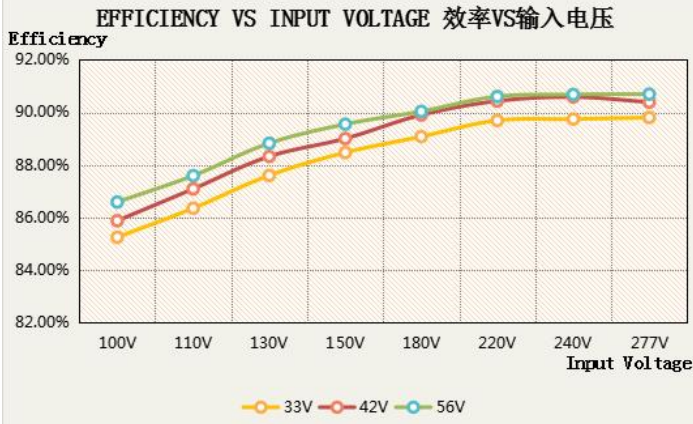

OVER-TEMPERATURE DROP CURRENT

过温降电流曲线

SCP-100-56X

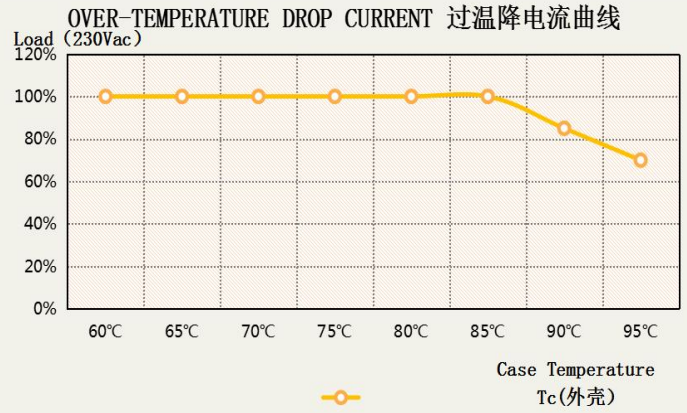

LOAD DERATING CURVE

降额曲线

SCP-100-56X

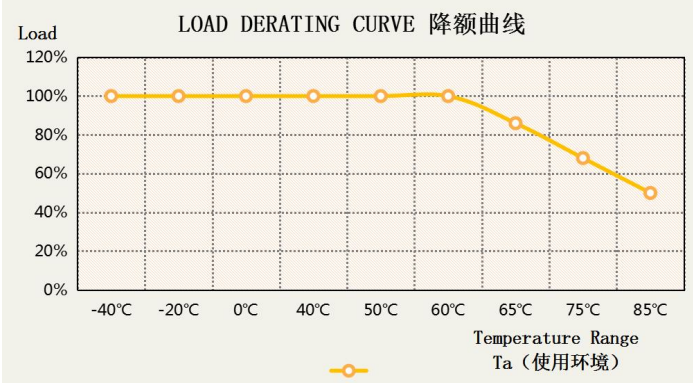

INPUT VOLTAGE VS LOADING

输入电压 VS 输出负载

SCP-100-56X

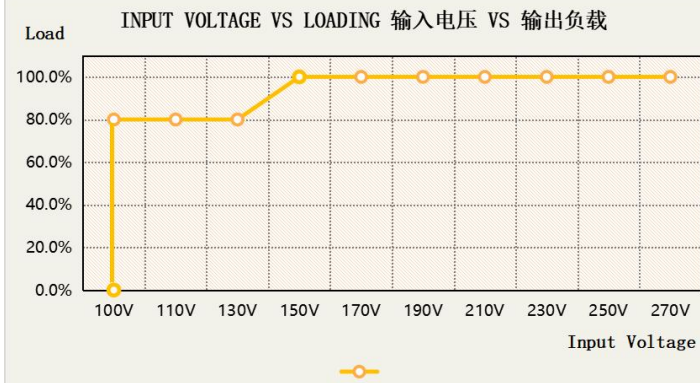

TCASE VS LIFETIME

壳温VS寿命

Tcase VS Lifetime 壳温 VS 寿命

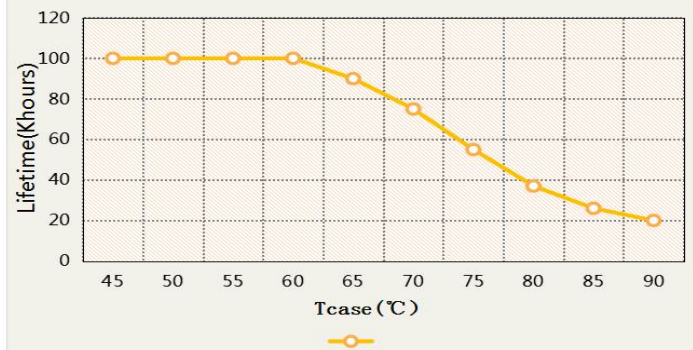

Under-voltage DROP CURRENT

欠压掉电流曲线

INPUT VOLTAGE VS OUTPUT Current 输入电压 VS 输出电流

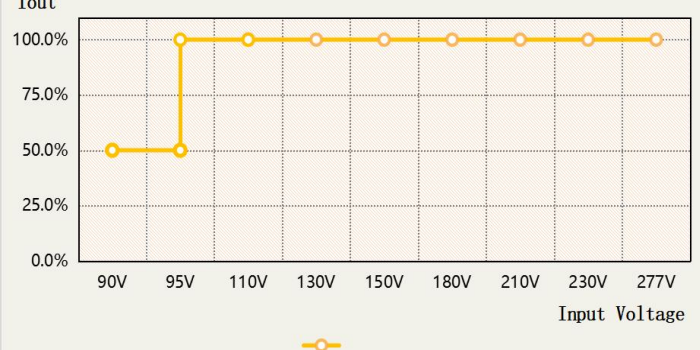

THE DIMMING CURVE 调光曲线

三合一调光功能 (B型/C型) :

- 在DIM+ (兰色线) 和DIM- (白色线) 间连接一个100K电阻或0-10V直流电压或PWM信号, 即可调整输出恒电流的数值
- 调光端口输出电流: 100uA (典型值)
- 辅助源功能 (C型): 12V辅组电源输出, 输出最大电流250mA

0-10V调光

■ 用外加0-10VDC电压

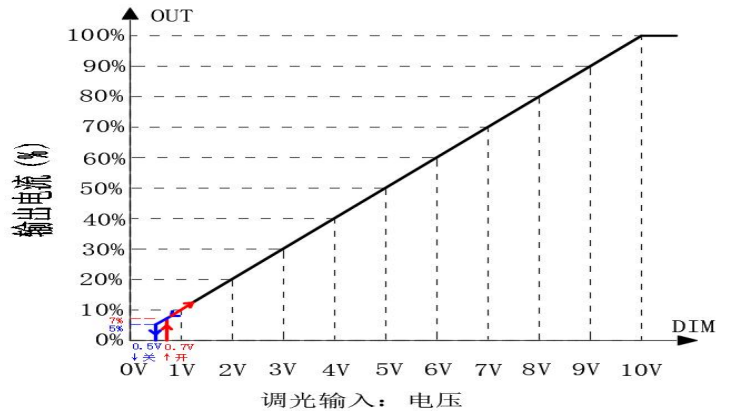
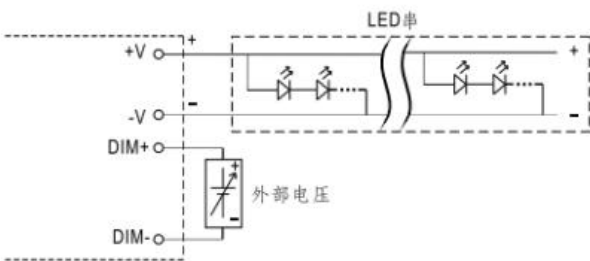

PWM调光 (PWM频率 10V 1KHZ)

■ 用外加10V PWM信号 (频率0.2K-10K)

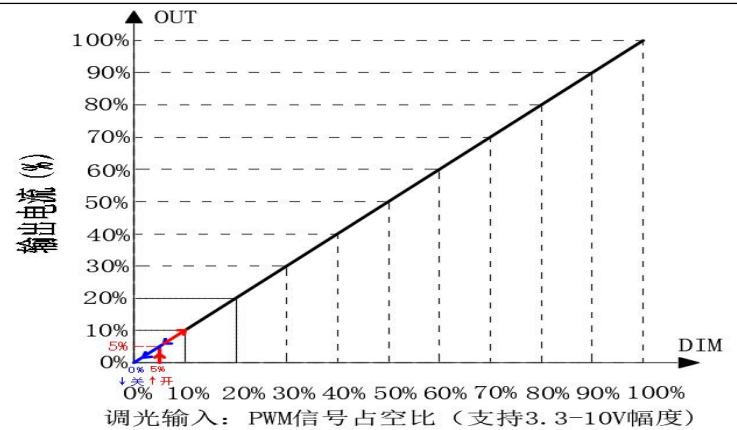
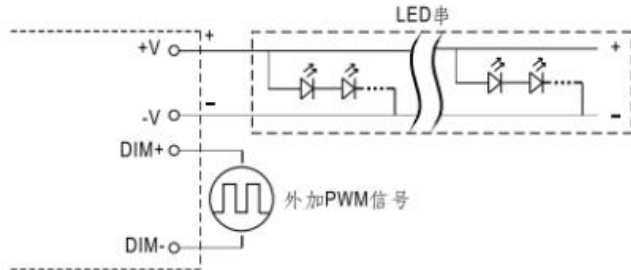

电阻调光 (100K)

■ 用外加电阻 (0-100K)

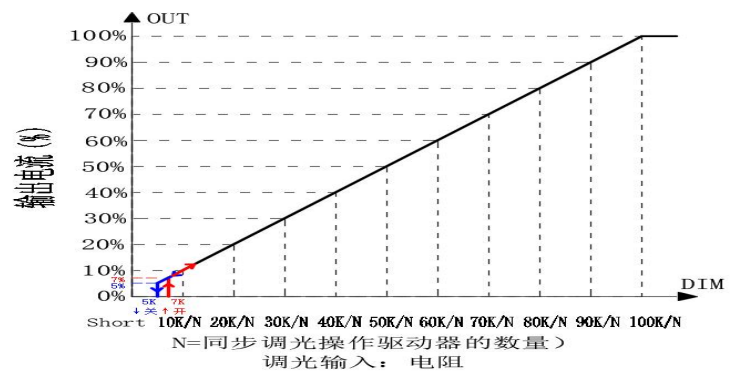
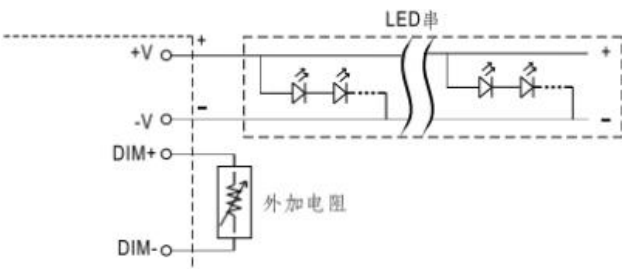

产品类型	LED 驱动电源 LED INTEGRATED SPECIAL DRIVER		
产品系列	SCP-100-56X系列	REV	V3.1

MECHANICAL SPECIFICATION & PACKING 机械尺寸图 & 包装:

Bare plate dimension 裸板尺寸	114*44*26mm (L*W*H)
final dimension 成品尺寸	143*49*33mm (L*W*H)
Product Weight 产品重量	420g

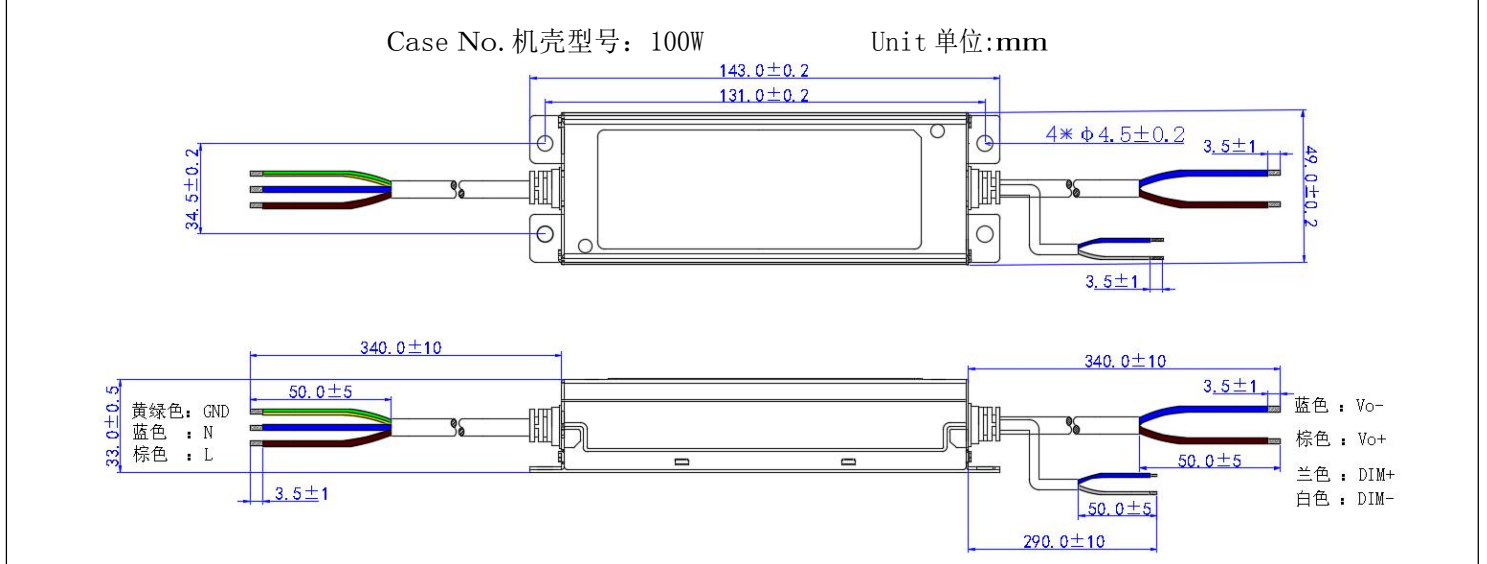

Nameplate 铭牌

尺寸: 84*31mm 样式: 贴纸

SCP-100-56A	SCP-100-56B																
<p>SUNCOM SCP-100-56A (型号)LED控制装置</p> <table border="1"> <tr> <th>INPUT 输入端</th> <td>Vin(输入):100-277V~1.4A 50/60Hz PF:≥0.95 ta:60°C tc:90°C</td> <th>OUTPUT 输出端</th> <td>Vout(输出):28-56V ≍ 1600-3000mA Max.Uout(最大电压): 70V ≍ Rated Power(额定功率):100W</td> </tr> <tr> <td> <input type="radio"/> ACN(BU蓝) <input type="radio"/> ACL(BN棕) <input checked="" type="radio"/> (GN绿/YL黄) </td> <td> 广东新创电源科技有限公司 www.gdsuncom.com GUANGDONG SUNCOM POWER TECHNOLOGY CO.,LTD </td> <td> <input type="radio"/> (BU蓝)Vo - ○ <input type="radio"/> (BN棕)Vo + ○ <input checked="" type="radio"/> (BN棕)Vo + ○ </td> <td> ta:50°C@Vin100-200V~ ta:60°C@Vin200-277V~ tc:90°C </td> </tr> </table> <p>MADE IN CHINA (中国制造) IP65 SELV</p>	INPUT 输入端	Vin(输入):100-277V~1.4A 50/60Hz PF:≥0.95 ta:60°C tc:90°C	OUTPUT 输出端	Vout(输出):28-56V ≍ 1600-3000mA Max.Uout(最大电压): 70V ≍ Rated Power(额定功率):100W	<input type="radio"/> ACN(BU蓝) <input type="radio"/> ACL(BN棕) <input checked="" type="radio"/> (GN绿/YL黄)	广东新创电源科技有限公司 www.gdsuncom.com GUANGDONG SUNCOM POWER TECHNOLOGY CO.,LTD	<input type="radio"/> (BU蓝)Vo - ○ <input type="radio"/> (BN棕)Vo + ○ <input checked="" type="radio"/> (BN棕)Vo + ○	ta:50°C@Vin100-200V~ ta:60°C@Vin200-277V~ tc:90°C	<p>SUNCOM SCP-100-56B (型号)LED控制装置</p> <table border="1"> <tr> <th>INPUT 输入端</th> <td>Vin(输入):100-277V~1.4A 50/60Hz PF:≥0.95 ta:60°C tc:90°C</td> <th>OUTPUT 输出端</th> <td>Vout(输出):28-56V ≍ 1600-3000mA Max.Uout(最大电压): 70V ≍ Rated Power(额定功率):100W</td> </tr> <tr> <td> <input type="radio"/> ACN(BU蓝) <input type="radio"/> ACL(BN棕) <input checked="" type="radio"/> (GN绿/YL黄) </td> <td> 广东新创电源科技有限公司 www.gdsuncom.com GUANGDONG SUNCOM POWER TECHNOLOGY CO.,LTD </td> <td> <input type="radio"/> (BU蓝)Vo - ○ <input type="radio"/> (BN棕)Vo + ○ <input type="radio"/> (BU蓝)DIM + ○ <input type="radio"/> (WH白)DIM - ○ </td> <td> ta:50°C@Vin100-200V~ ta:60°C@Vin200-277V~ tc:90°C </td> </tr> </table> <p>MADE IN CHINA (中国制造) IP65 SELV</p>	INPUT 输入端	Vin(输入):100-277V~1.4A 50/60Hz PF:≥0.95 ta:60°C tc:90°C	OUTPUT 输出端	Vout(输出):28-56V ≍ 1600-3000mA Max.Uout(最大电压): 70V ≍ Rated Power(额定功率):100W	<input type="radio"/> ACN(BU蓝) <input type="radio"/> ACL(BN棕) <input checked="" type="radio"/> (GN绿/YL黄)	广东新创电源科技有限公司 www.gdsuncom.com GUANGDONG SUNCOM POWER TECHNOLOGY CO.,LTD	<input type="radio"/> (BU蓝)Vo - ○ <input type="radio"/> (BN棕)Vo + ○ <input type="radio"/> (BU蓝)DIM + ○ <input type="radio"/> (WH白)DIM - ○	ta:50°C@Vin100-200V~ ta:60°C@Vin200-277V~ tc:90°C
INPUT 输入端	Vin(输入):100-277V~1.4A 50/60Hz PF:≥0.95 ta:60°C tc:90°C	OUTPUT 输出端	Vout(输出):28-56V ≍ 1600-3000mA Max.Uout(最大电压): 70V ≍ Rated Power(额定功率):100W														
<input type="radio"/> ACN(BU蓝) <input type="radio"/> ACL(BN棕) <input checked="" type="radio"/> (GN绿/YL黄)	广东新创电源科技有限公司 www.gdsuncom.com GUANGDONG SUNCOM POWER TECHNOLOGY CO.,LTD	<input type="radio"/> (BU蓝)Vo - ○ <input type="radio"/> (BN棕)Vo + ○ <input checked="" type="radio"/> (BN棕)Vo + ○	ta:50°C@Vin100-200V~ ta:60°C@Vin200-277V~ tc:90°C														
INPUT 输入端	Vin(输入):100-277V~1.4A 50/60Hz PF:≥0.95 ta:60°C tc:90°C	OUTPUT 输出端	Vout(输出):28-56V ≍ 1600-3000mA Max.Uout(最大电压): 70V ≍ Rated Power(额定功率):100W														
<input type="radio"/> ACN(BU蓝) <input type="radio"/> ACL(BN棕) <input checked="" type="radio"/> (GN绿/YL黄)	广东新创电源科技有限公司 www.gdsuncom.com GUANGDONG SUNCOM POWER TECHNOLOGY CO.,LTD	<input type="radio"/> (BU蓝)Vo - ○ <input type="radio"/> (BN棕)Vo + ○ <input type="radio"/> (BU蓝)DIM + ○ <input type="radio"/> (WH白)DIM - ○	ta:50°C@Vin100-200V~ ta:60°C@Vin200-277V~ tc:90°C														
SCP-100-56C																	
<p>SUNCOM SCP-100-56C (型号)LED控制装置</p> <table border="1"> <tr> <th>INPUT 输入端</th> <td>Vin(输入):100-277V~1.4A 50/60Hz PF:≥0.95 ta:60°C tc:90°C</td> <th>OUTPUT 输出端</th> <td>Vout(输出):28-56V ≍ 1600-3000mA Max.Uout(最大电压): 70V ≍ Rated Power(额定功率):100W</td> </tr> <tr> <td> <input type="radio"/> ACN(BU蓝) <input type="radio"/> ACL(BN棕) <input checked="" type="radio"/> (GN绿/YL黄) </td> <td> 广东新创电源科技有限公司 www.gdsuncom.com GUANGDONG SUNCOM POWER TECHNOLOGY CO.,LTD </td> <td> <input type="radio"/> (BU蓝)Vo - ○ <input type="radio"/> (BN棕)Vo + ○ <input type="radio"/> (VT紫)DIM + ○ <input type="radio"/> (GY灰) DIM - /12V - ○ <input type="radio"/> (PK粉) 12V + ○ </td> <td> ta:50°C@Vin100-200V~ ta:60°C@Vin200-277V~ tc:90°C </td> </tr> </table> <p>MADE IN CHINA (中国制造) IP65 SELV</p>	INPUT 输入端	Vin(输入):100-277V~1.4A 50/60Hz PF:≥0.95 ta:60°C tc:90°C	OUTPUT 输出端	Vout(输出):28-56V ≍ 1600-3000mA Max.Uout(最大电压): 70V ≍ Rated Power(额定功率):100W	<input type="radio"/> ACN(BU蓝) <input type="radio"/> ACL(BN棕) <input checked="" type="radio"/> (GN绿/YL黄)	广东新创电源科技有限公司 www.gdsuncom.com GUANGDONG SUNCOM POWER TECHNOLOGY CO.,LTD	<input type="radio"/> (BU蓝)Vo - ○ <input type="radio"/> (BN棕)Vo + ○ <input type="radio"/> (VT紫)DIM + ○ <input type="radio"/> (GY灰) DIM - /12V - ○ <input type="radio"/> (PK粉) 12V + ○	ta:50°C@Vin100-200V~ ta:60°C@Vin200-277V~ tc:90°C									
INPUT 输入端	Vin(输入):100-277V~1.4A 50/60Hz PF:≥0.95 ta:60°C tc:90°C	OUTPUT 输出端	Vout(输出):28-56V ≍ 1600-3000mA Max.Uout(最大电压): 70V ≍ Rated Power(额定功率):100W														
<input type="radio"/> ACN(BU蓝) <input type="radio"/> ACL(BN棕) <input checked="" type="radio"/> (GN绿/YL黄)	广东新创电源科技有限公司 www.gdsuncom.com GUANGDONG SUNCOM POWER TECHNOLOGY CO.,LTD	<input type="radio"/> (BU蓝)Vo - ○ <input type="radio"/> (BN棕)Vo + ○ <input type="radio"/> (VT紫)DIM + ○ <input type="radio"/> (GY灰) DIM - /12V - ○ <input type="radio"/> (PK粉) 12V + ○	ta:50°C@Vin100-200V~ ta:60°C@Vin200-277V~ tc:90°C														