

## High Voltage LED Series Chip on Board

# - Small LES COB line-up - C-Series Gen.2

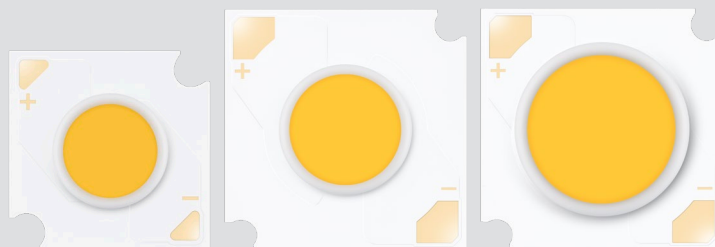

High efficacy COB LED package  
well-suited for use in spotlight applications

### Features & Benefits

- Chip on Board (COB) solution makes it easy to design in
- Simple assembly reduces manufacturing cost
- Low thermal resistance
- InGaN/GaN MQW LED with long time reliability

### Applications

- Spotlight / Downlight
- LED Retrofit Bulbs
- Outdoor Illumination



## Table of Contents

1.	Characteristics	-----	3
2.	Product Code Information	-----	6
3.	Typical Characteristics Graphs	-----	10
4.	Outline Drawing & Dimension	-----	13
5.	Label Structure	-----	17
6.	Packing Structure	-----	18
7.	Precautions in Handling & Use	-----	20

## 1. Characteristics

### a) Absolute Maximum Rating

Item	Symbol	Model	Rating	Unit	Condition
Ambient / Operating Temperature	$T_a$	All model	-40 ~ +105	°C	-
Storage Temperature	$T_{stg}$	All model	-40 ~ +120	°C	-
LED Junction Temperature	$T_J$	All model	140	°C	-
Case Temperature	$T_c$	All model	105	°C	-
Forward Current	$I_F$	LC010C	380	mA	-
		LC020C	920		
		LC030C	1380		
		LC040C	1610		
Power Dissipation	$P_D$	LC010C	13.8	W	-
		LC020C	34.0		
		LC030C	51.1		
		LC040C	59.5		
ESD (HBM)	-		±2	kV	-

### b) Electro-optical Characteristics ( $I_F$ = Sorting Current, $T_J = 85$ °C)

Item	Unit	Rank	Min.	Typ.	Max.
Forward Voltage ( $V_F$ )	V	YZ	32.0	35.0	38.0
Color Rendering Index ( $R_a$ )	-	5	80	-	-
		7	90	-	-
Thermal Resistance (junction to case point)	°C/W	LC010C	-	1.5	-
		LC020C	-	0.9	-
		LC030C	-	0.6	-
		LC040C	-	0.5	-
Beam Angle	°		-	115	-
Nominal Power / Sorting Current	W / mA	LC010C		10.5 / 300	
		LC020C		21.0 / 600	
		LC030C		31.5 / 900	
		LC040C		36.8 / 1050	

#### Notes:

- 1) The COB is tested in pulsed condition at rated test current (10 ms pulse width) and rated temperature ( $T_J = T_C = T_a = 85$  °C)
- 2) Samsung maintains measurement tolerance of: forward voltage = ±5 %, CRI = ±1
- 3) Refer to the derating curve, '3. Typical Characteristics Graph' designed within the range.

c) Luminous Flux Characteristics (I<sub>F</sub> = Sorting Current)

Model	CRI (Ra) Min.	Nominal CCT (K)	Flux Rank	Flux @ T <sub>J</sub> = 85 °C (lm)		
				Min.	Typ.	Max.
LC010C	80	2700	C2	1151	1212	-
		3000	C2	1210	1274	-
		3500	C2	1245	1311	-
		4000	C2	1270	1337	-
		5000	C2	1281	1348	-
LC020C	80	2700	C2	2361	2485	-
		3000	C2	2494	2625	-
		3500	C2	2554	2688	-
		4000	C2	2605	2742	-
		5000	C2	2627	2765	-
LC030C	80	2700	C2	3576	3765	-
		3000	C2	3758	3956	-
		3500	C2	3868	4072	-
		4000	C2	3946	4154	-
		5000	C2	3979	4188	-
LC040C	80	2700	C2	4090	4305	-
		3000	C2	4298	4524	-
		3500	C2	4424	4657	-
		4000	C2	4513	4750	-
		5000	C2	4550	4790	-

### c) Luminous Flux Characteristics (I<sub>F</sub> = Sorting Current)

Model	CRI (Ra) Min.	Nominal CCT (K)	Flux Rank	Flux @ T <sub>J</sub> = 85 °C (lm)		
				Min.	Typ.	Max.
LC010C	90	2700	C2	985	1037	-
		3000	C2	1036	1091	-
		3500	C2	1067	1123	-
		4000	C2	1089	1147	-
		5000	C2	1099	1156	-
LC020C	90	2700	C2	2021	2127	-
		3000	C2	2125	2237	-
		3500	C2	2189	2304	-
		4000	C2	2234	2351	-
		5000	C2	2253	2372	-
LC030C	90	2700	C2	3061	3222	-
		3000	C2	3219	3389	-
		3500	C2	3315	3490	-
		4000	C2	3384	3562	-
		5000	C2	3413	3592	-
LC040C	90	2700	C2	3500	3684	-
		3000	C2	3682	3875	-
		3500	C2	3791	3991	-
		4000	C2	3869	4073	-
		5000	C2	3903	4108	-

#### Notes:

- 1) The COB is tested in pulsed operating condition at rated test current (10 ms pulse width) and rated temperature (T<sub>J</sub> = T<sub>C</sub> = 85 °C).
- 2) Samsung maintains measurement tolerance of: Luminous flux = ±7 %, CRI = ±1

## 2. Product Code Information

1	2	3	4	5	6	7	8	9	10	11	12	13	14	15	16	17	18
S	P	H	W	H	A	H	D	N	C	2	5	Y	Z	W	3	C	2

Digit	PKG Information	Code	Specification
1 2 3	Samsung Package High Power	<b>SPH</b>	
4 5	Color	<b>WH</b>	White
6	Product Version	<b>A</b>	
7 8	Form Factor	<b>HD</b>	COB
9	Lens Type	<b>N</b>	No lens
10	Wattage or Model	<b>C</b>	LC010C
		<b>F</b>	LC020C
		<b>H</b>	LC030C
		<b>K</b>	LC040C
11	Internal Code	<b>2</b>	
12	CRI & Sorting Temperature	<b>5</b>	Min. 80 (85°C)
		<b>7</b>	Min. 90 (85°C)
13 14	Forward Voltage (V)	<b>YZ</b>	32.0 ~ 38.0
15	CCT (K)	<b>W</b>	2700K
		<b>V</b>	3000K
		<b>U</b>	3500K
		<b>T</b>	4000K
		<b>R</b>	5000K
16	MacAdam Step	<b>3</b>	MacAdam 3-step
17 18	Luminous Flux (Lm)	<b>C2</b>	COB C-series Gen2

a) Binning Structure ( $I_F$  = Sorting Current,  $T_J$  = 85 °C)

Model	CRI (Ra) Min.	Nominal CCT (K)	Product Code	$V_F$ Rank	Color Rank	Flux Rank	Flux Range ( $\Phi_v$ , lm)
LC010C	80	2700	SPHWAHDNC25YZW3C2	YZ	W3	C2	1151 ~
		3000	SPHWAHDNC25YZV3C2	YZ	V3	C2	1210 ~
		3500	SPHWAHDNC25YZU3C2	YZ	U3	C2	1245 ~
		4000	SPHWAHDNC25YZT3C2	YZ	T3	C2	1270 ~
		5000	SPHWAHDNC25YZR3C2	YZ	R3	C2	1281 ~
LC020C	80	2700	SPHWAHDNF25YZW3C2	YZ	W3	C2	2361 ~
		3000	SPHWAHDNF25YZV3C2	YZ	V3	C2	2494 ~
		3500	SPHWAHDNF25YZU3C2	YZ	U3	C2	2554 ~
		4000	SPHWAHDNF25YZT3C2	YZ	T3	C2	2605 ~
		5000	SPHWAHDNF25YZR3C2	YZ	R3	C2	2627 ~
LC030C	80	2700	SPHWAHDNH25YZW3C2	YZ	W3	C2	3576 ~
		3000	SPHWAHDNH25YZV3C2	YZ	V3	C2	3758 ~
		3500	SPHWAHDNH25YZU3C2	YZ	U3	C2	3868 ~
		4000	SPHWAHDNH25YZT3C2	YZ	T3	C2	3946 ~
		5000	SPHWAHDNH25YZR3C2	YZ	R3	C2	3979 ~
LC040C	80	2700	SPHWAHDNK25YZW3C2	YZ	W3	C2	4090 ~
		3000	SPHWAHDNK25YZV3C2	YZ	V3	C2	4298 ~
		3500	SPHWAHDNK25YZU3C2	YZ	U3	C2	4424 ~
		4000	SPHWAHDNK25YZT3C2	YZ	T3	C2	4513 ~
		5000	SPHWAHDNK25YZR3C2	YZ	R3	C2	4550 ~

a) Binning Structure (I<sub>F</sub> = Sorting Current, T<sub>J</sub> = 85 °C)

Model	CRI (Ra) Min.	Nominal CCT (K)	Product Code	V <sub>F</sub> Rank	Color Rank	Flux Rank	Flux Range (Φ <sub>v</sub> , lm)
LC010C	90	2700	SPHWAHDNC27YZW3C2	YZ	W3	C2	985 ~
		3000	SPHWAHDNC27YZV3C2	YZ	V3	C2	1036 ~
		3500	SPHWAHDNC27YZU3C2	YZ	U3	C2	1067 ~
		4000	SPHWAHDNC27YZT3C2	YZ	T3	C2	1089 ~
		5000	SPHWAHDNC27YZR3C2	YZ	R3	C2	1099 ~
LC020C	90	2700	SPHWAHDNF27YZW3C2	YZ	W3	C2	2021 ~
		3000	SPHWAHDNF27YZV3C2	YZ	V3	C2	2125 ~
		3500	SPHWAHDNF27YZU3C2	YZ	U3	C2	2189 ~
		4000	SPHWAHDNF27YZT3C2	YZ	T3	C2	2234 ~
		5000	SPHWAHDNF27YZR3C2	YZ	R3	C2	2253 ~
LC030C	90	2700	SPHWAHDNH27YZW3C2	YZ	W3	C2	3061 ~
		3000	SPHWAHDNH27YZV3C2	YZ	V3	C2	3219 ~
		3500	SPHWAHDNH27YZU3C2	YZ	U3	C2	3315 ~
		4000	SPHWAHDNH27YZT3C2	YZ	T3	C2	3384 ~
		5000	SPHWAHDNH27YZR3C2	YZ	R3	C2	3413 ~
LC040C	90	2700	SPHWAHDNK27YZW3C2	YZ	W3	C2	3500 ~
		3000	SPHWAHDNK27YZV3C2	YZ	V3	C2	3682 ~
		3500	SPHWAHDNK27YZU3C2	YZ	U3	C2	3791 ~
		4000	SPHWAHDNK27YZT3C2	YZ	T3	C2	3869 ~
		5000	SPHWAHDNK27YZR3C2	YZ	R3	C2	3903 ~



b) Chromaticity Region & Coordinates ( $I_F$  = Sorting Current,  $T_J$  = 85 °C)

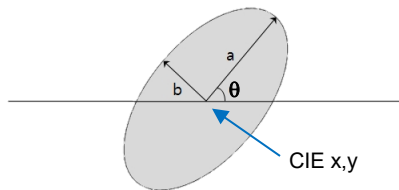
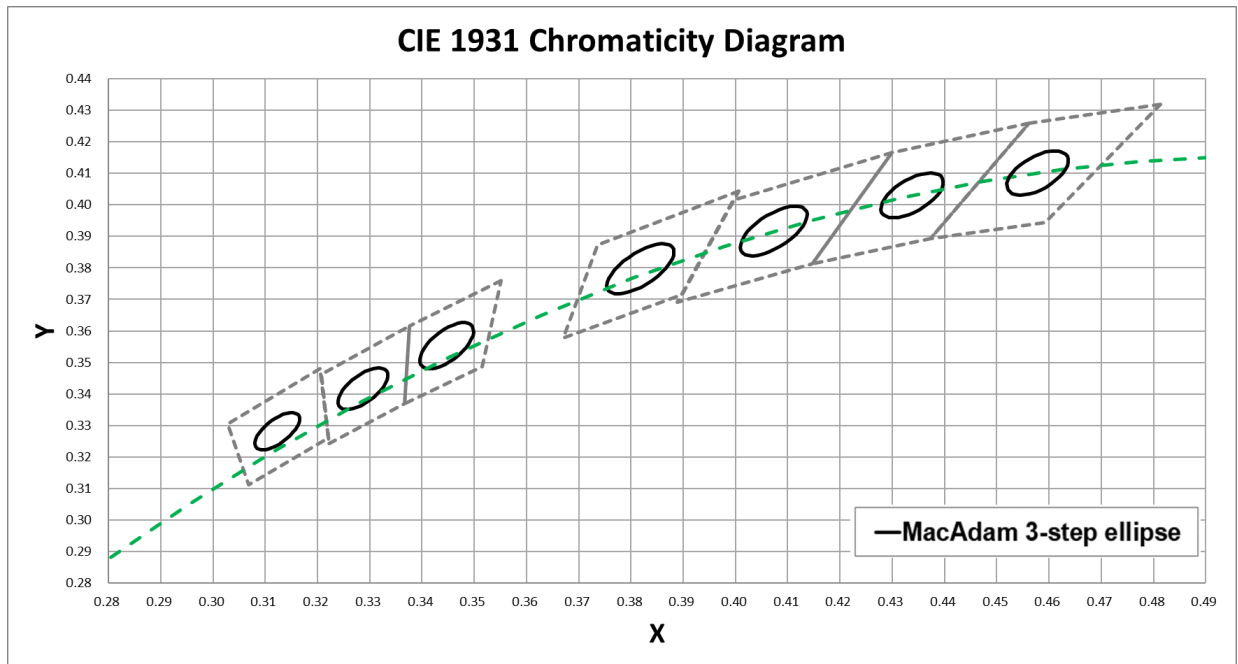

MacAdam Ellipse (W2, W3)					
Step	CIE x	CIE y	$\theta$	a	b
3-step	0.4578	0.4101	53.70	0.0081	0.0042

MacAdam Ellipse (V2, V3)					
Step	CIE x	CIE y	$\theta$	a	b
3-step	0.4338	0.4030	53.22	0.0083	0.0041

MacAdam Ellipse (U2, U3)					
Step	CIE x	CIE y	$\theta$	a	b
3-step	0.4073	0.3917	54.00	0.0093	0.0041

MacAdam Ellipse (T2, T3)					
Step	CIE x	CIE y	$\theta$	a	b
3-step	0.3818	0.3797	53.72	0.0094	0.0040

MacAdam Ellipse (R3)					
Step	CIE x	CIE y	$\theta$	a	b
3-step	0.3447	0.3553	59.62	0.0082	0.0035

MacAdam Ellipse (Q3)					
Step	CIE x	CIE y	$\theta$	a	b
3-step	0.3287	0.3417	59.0950	0.0075	0.0032

MacAdam Ellipse (P3)					
Step	CIE x	CIE y	$\theta$	a	b
3-step	0.3123	0.3282	58.5700	0.0067	0.0029

**Note:**

Samsung maintains measurement tolerance of:  $C_x, C_y = \pm 0.005$

### 3. Typical Characteristics Graphs

a) Spectrum Distribution ( $I_f$  = Sorting Current,  $T_c$  = 25 °C)

CRI Ra 80+

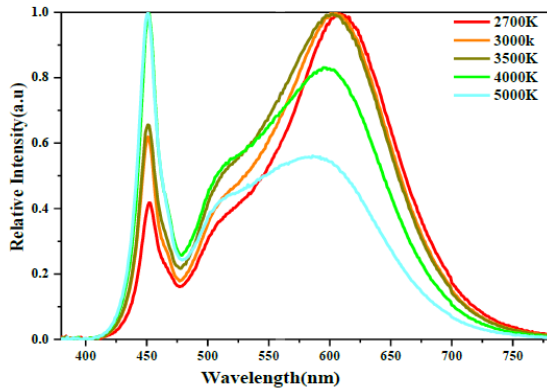

CRI Ra 90+

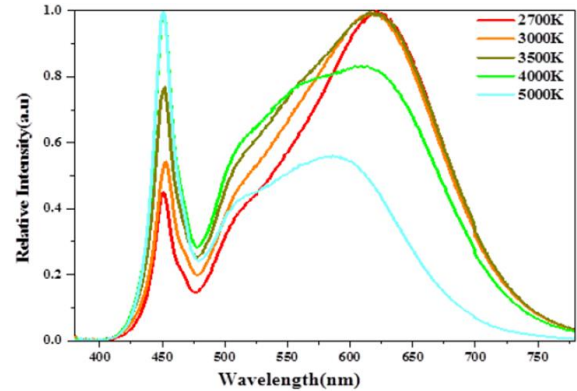

b) Forward Current Characteristics ( $T_c$  = 85 °C)

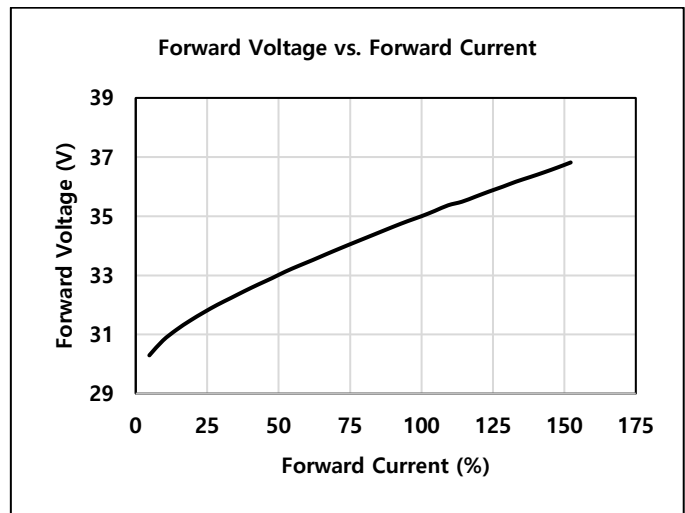
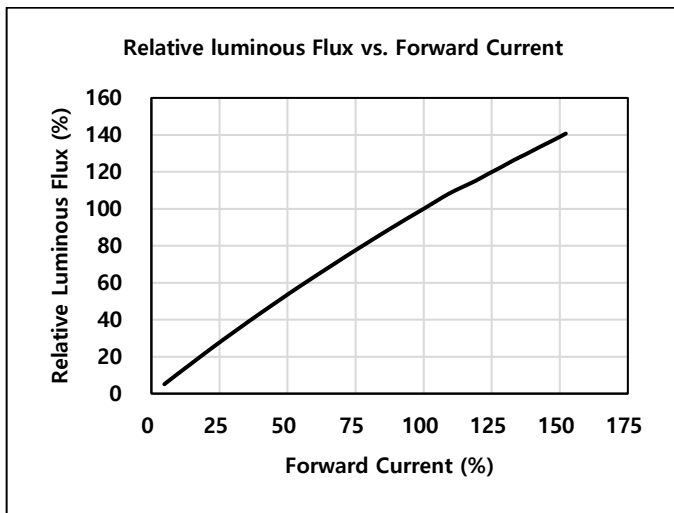

c) Temperature Characteristics ( $I_f$  = Sorting Current)

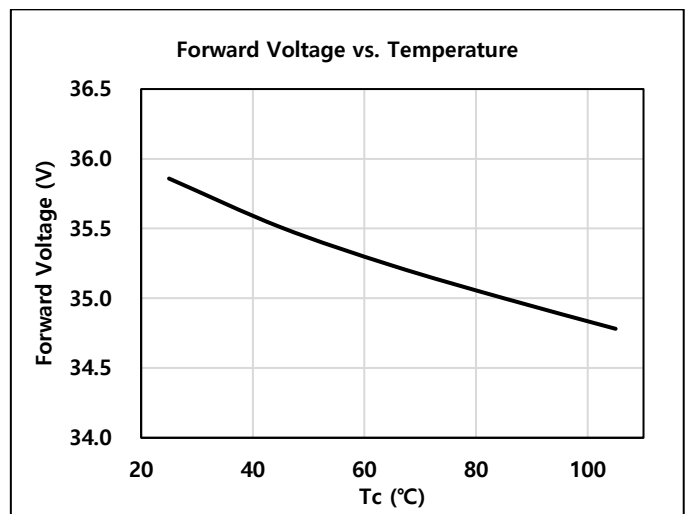
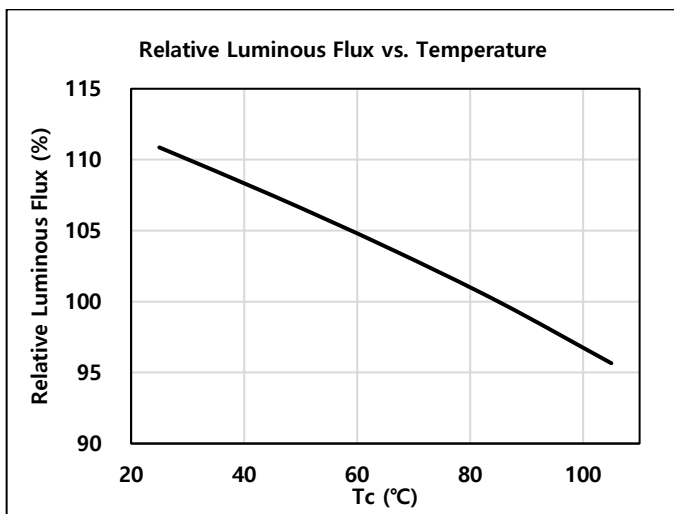

d) Color Shift Characteristics ( $T_c = 25\text{ }^\circ\text{C}$ ,  $I_f = \text{Sorting Current}$ ,  $\text{CRI} = 80+$ )

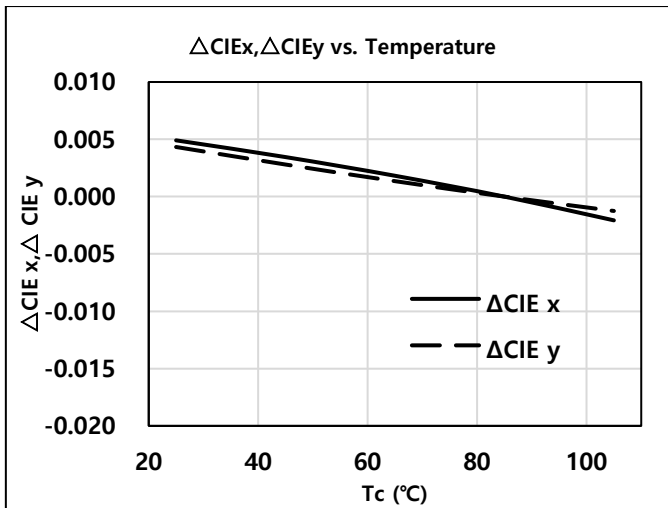
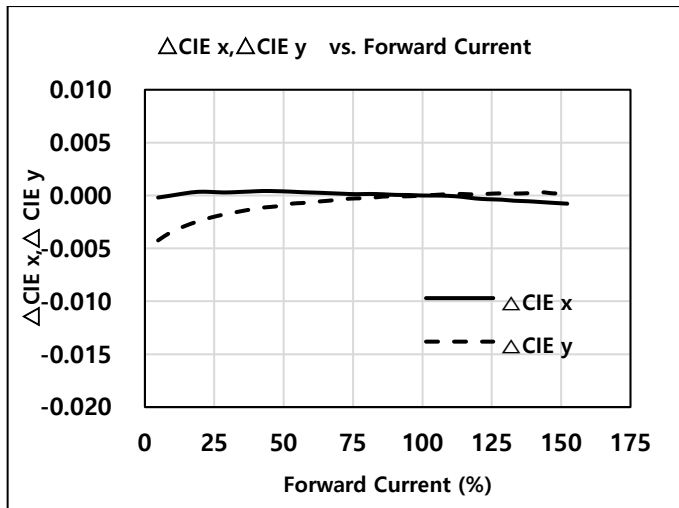

e) Beam Angle Characteristics ( $I_f = \text{Sorting Current}$ ,  $T_c = 25\text{ }^\circ\text{C}$ )

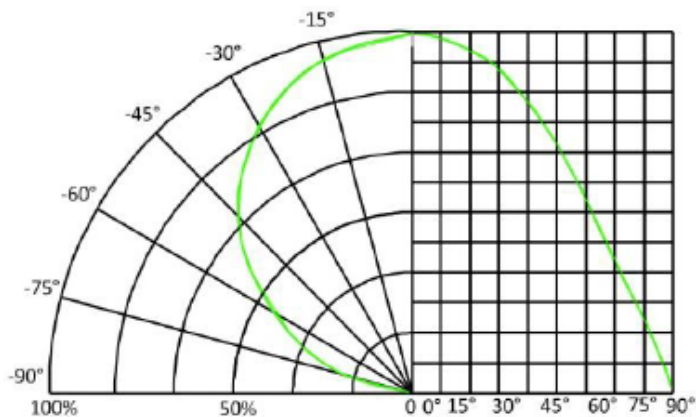

## f) Derating Characteristics

LC010C

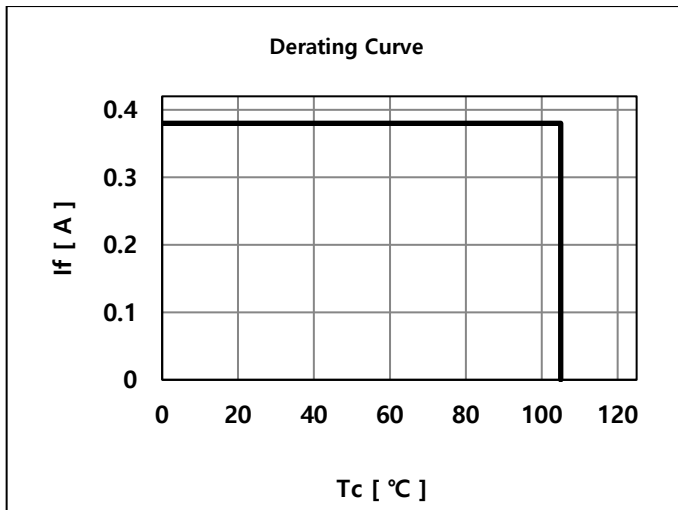

LC020C

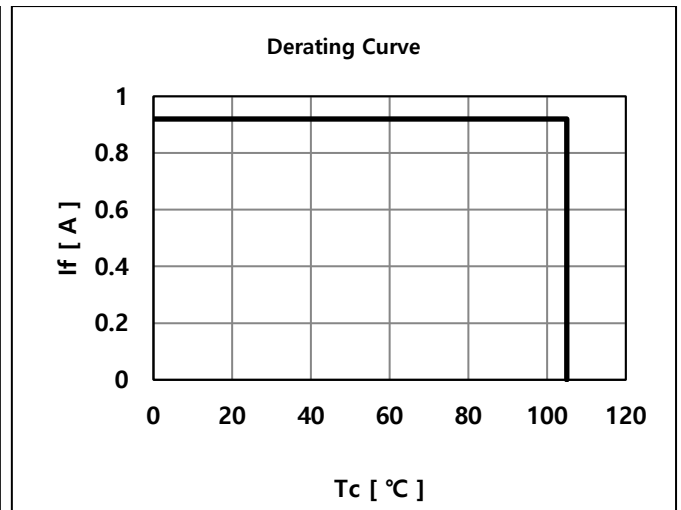

LC030C

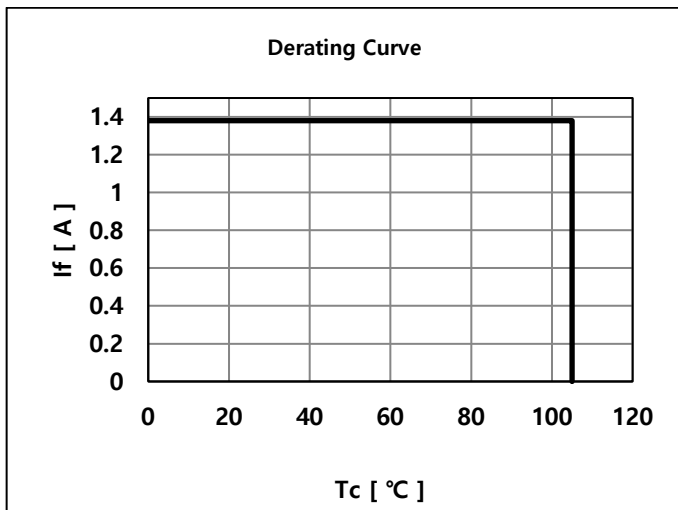

LC040C

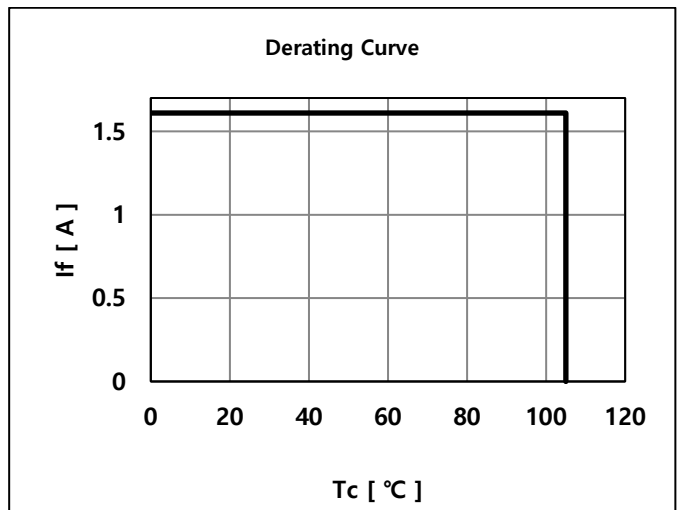

4. Outline Drawing & Dimension

a) LCo10C

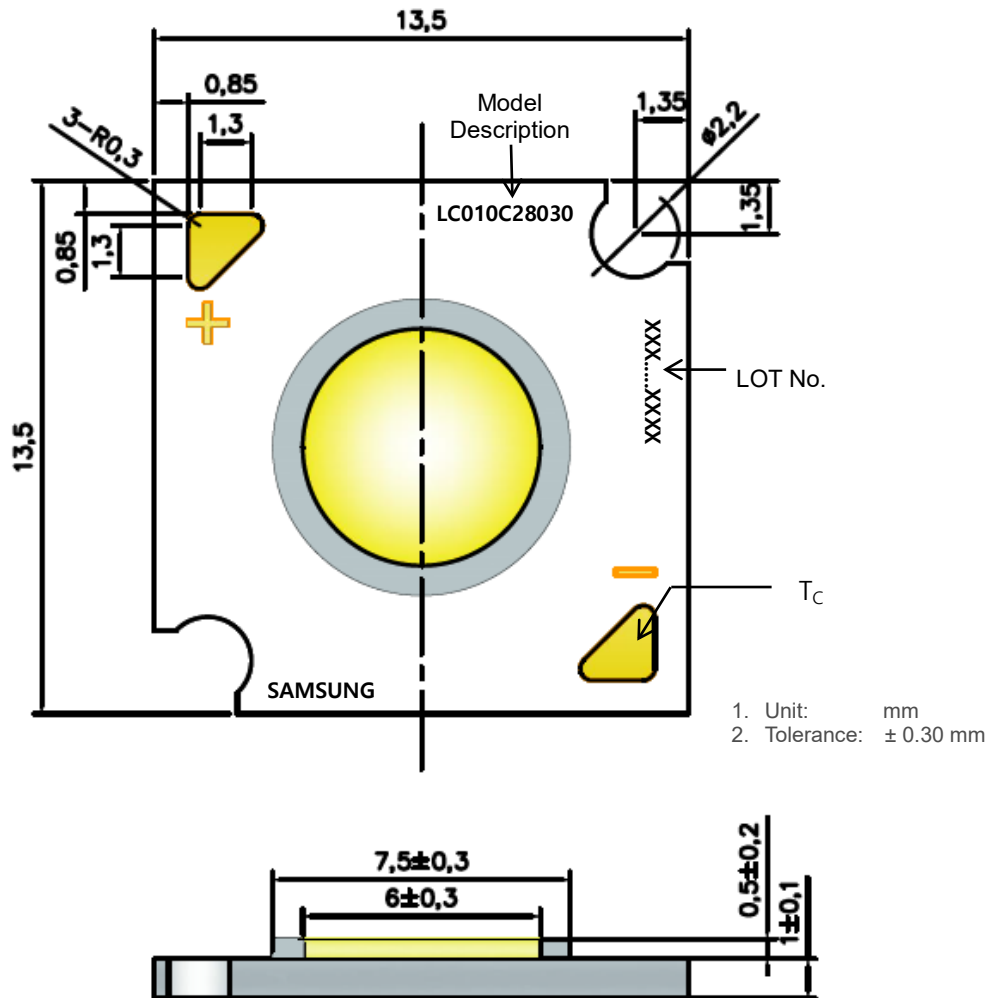

Item	Dimension	Tolerance	Unit
Length	13.5	±0.15	mm
Width	13.5	±0.15	mm
Height	Dam	±0.20	mm
	Substrate	±0.10	mm
LES Diameter	Light Emitting Surface	±0.30	mm

Note: Denoted product information above is only an example  
( LC010C2 8030 : LC010C, Gen2, CRI80+, 3000K )

b) LC020C

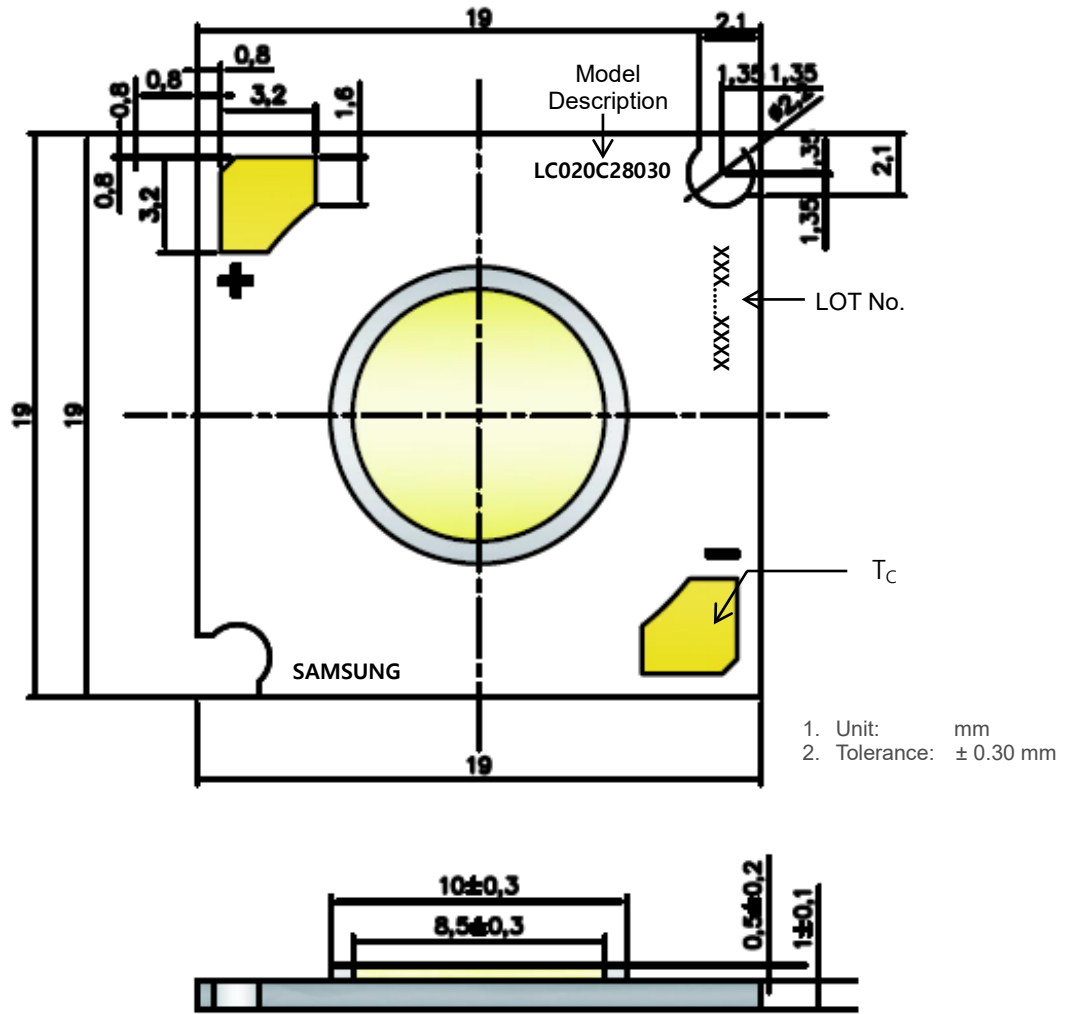

Item	Dimension	Tolerance	Unit
Length	19.0	±0.15	mm
Width	19.0	±0.15	mm
Height	Dam	±0.20	mm
	Substrate	±0.10	mm
LES Diameter	Light Emitting Surface	±0.30	mm

Note: Denoted product information above is only an example  
 ( LC020C2 8030 : LC020C, Gen2, CRI80+, 3000K )

c) LCo3oC

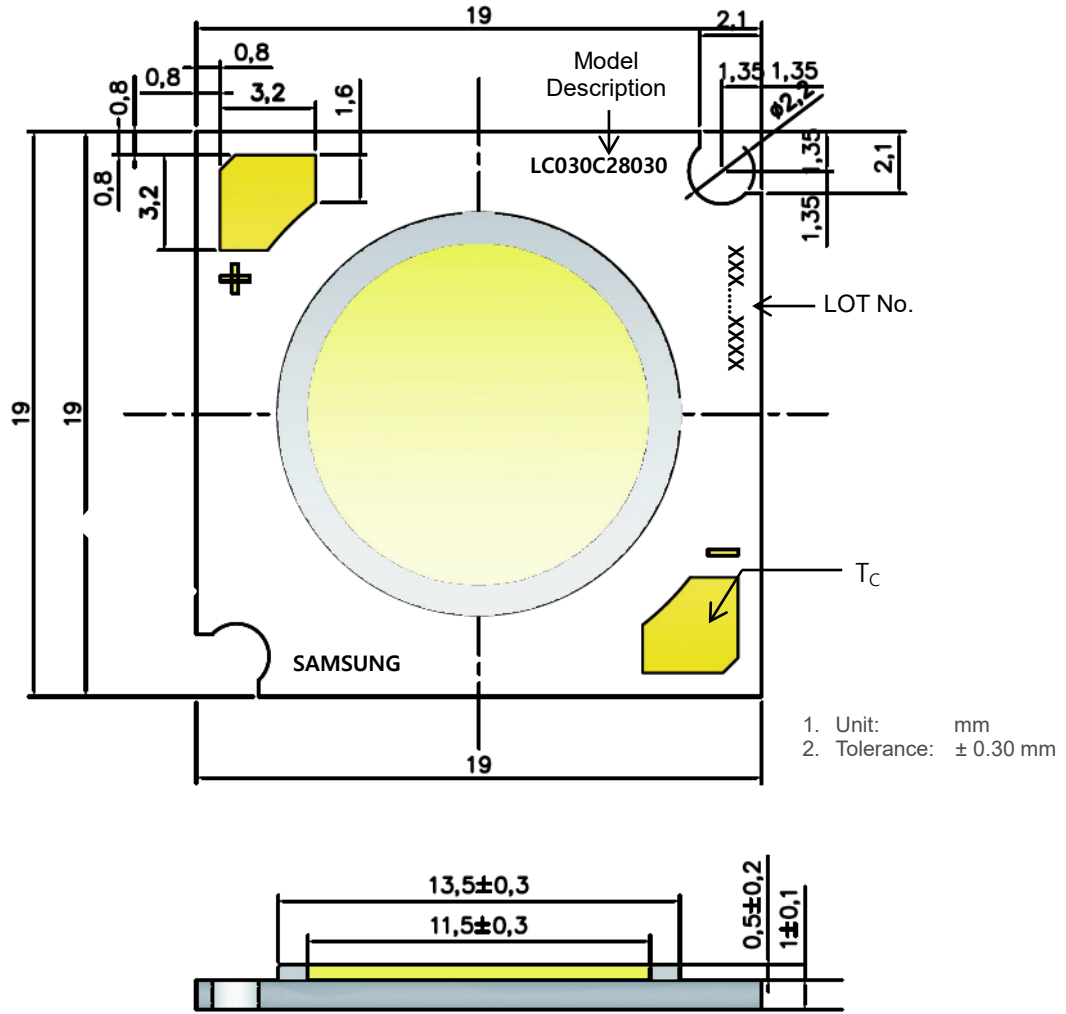

Item	Dimension	Tolerance	Unit	
Length	19.0	±0.15	mm	
Width	19.0	±0.15	mm	
Height	Dam	0.5	±0.20	mm
	Substrate	1.0	±0.10	mm
LES Diameter	Light Emitting Surface	11.5	±0.30	mm

Note: Denoted product information above is only an example  
 ( LC030C2 8030 : LC030C, Gen2, CRI80+, 3000K )

d) LCo4oC

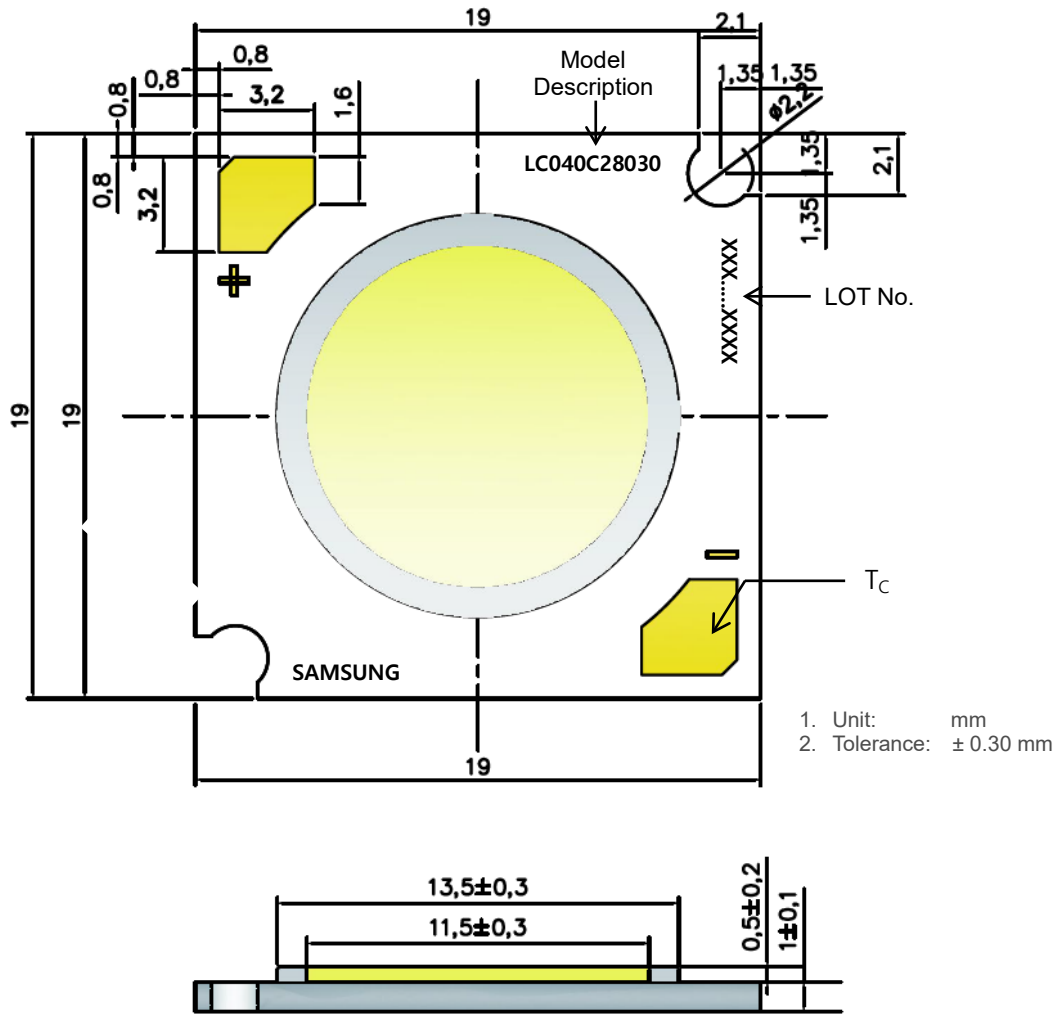

Item	Dimension	Tolerance	Unit
Length	19.0	±0.15	mm
Width	19.0	±0.15	mm
Height	Dam	±0.20	mm
	Substrate	±0.10	mm
LES Diameter	Light Emitting Surface	±0.30	mm

Note: Denoted product information above is only an example  
 ( LC040C2 8030 : LC040C, Gen2, CRI80+, 3000K )



## 5. Label Structure

### a) Label Structure

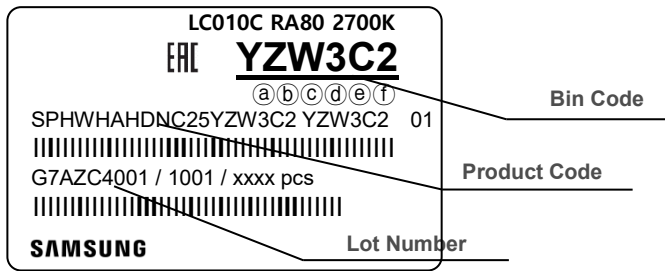

Note: Denoted bin code and product code above is only an example (see description on page 5)

Bin Code:

- ⒶⒷ: Forward Voltage bin (refer to page 11)
- ⒸⒹ: Chromaticity bin (refer to page 9-10)
- ⒺⒻ: Luminous Flux bin (refer to page 6)

### b) Lot Number

The lot number is composed of the following characters:

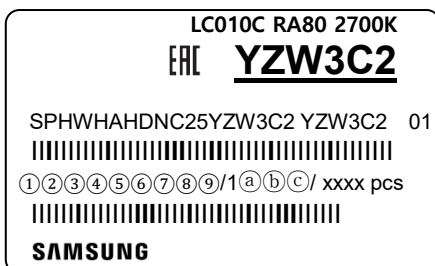

① ③④⑤⑥⑦⑧⑨ / 1ⒶⒷⒸ / xxxx pcs

- ① : Production site (S: Giheung, Korea, G: Tianjin, China)
- ② : 7 (LED)
- ③ : Product state (A: Normal, B: Bulk, C: First Production, R: Reproduction, S: Sample)
- ④ : Year (Z: 2015, A: 2016, B: 2017...)
- ⑤ : Month (1~9, A, B, C)
- ⑥⑦⑧⑨ : Day (1~9, A, B~V)
- ⒶⒷⒸ : Product serial number (001 ~ 999)



- LC020C / LC030C / LC040C

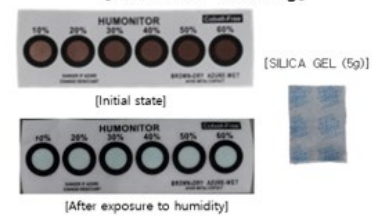
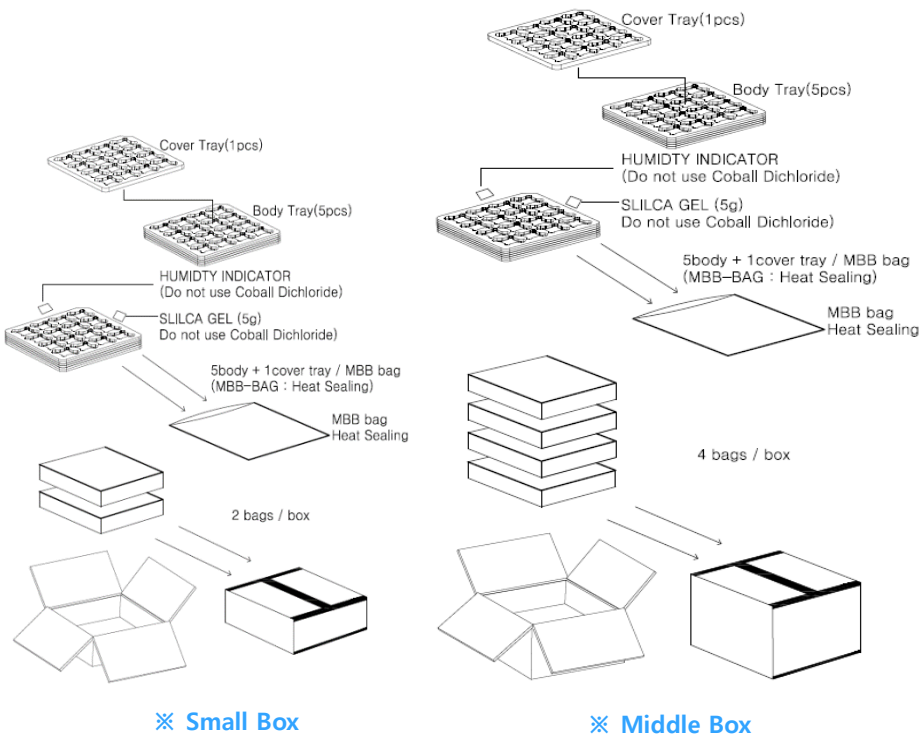

c) Tray

- LC010C

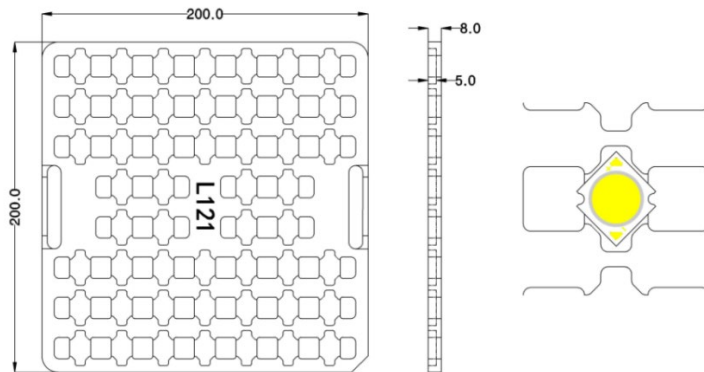

- LC020C / LC030C / LC040C

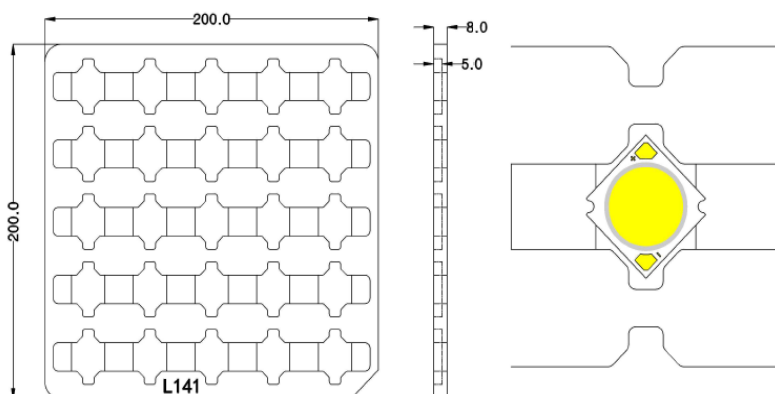

## 7. Precautions in Handling & Use

- 1) This device should not be used in any type of fluid such as water, oil, organic solvent, etc. Some solvent-based cleaning agent may damage the silicone resins used in the device.
- 2) LEDs must be stored in a clean environment. Shelf life of sealed bags is 12 months at temperature 0~40 °C, 0~90 % RH.
- 3) After storage bag is opened, device subjected to soldering (wiring), or other high temperature processes must be:
  - a. Mounted within 672 hours (28 days) at an assembly line with a condition of no more than 30 °C / 60 % RH, or
  - b. Stored at <10 % RH
- 4) Repack unused products with anti-moisture packing, fold to close any opening and then store in a dry place.
- 5) Devices require baking before mounting, if humidity card reading is >60 % at 23 ± 5 °C.
- 6) Devices must be baked for 1 hour at 60 ± 5 °C, if baking is required.
- 7) The LEDs are sensitive to the static electricity and surge current. It is recommended to use a wrist band or anti-electrostatic glove when handling the LEDs. If voltage exceeding the absolute maximum rating is applied to LEDs, it may cause damage or even destruction to LED devices. Damaged LEDs may show some unusual characteristics such as increase in leakage current, lowered turn-on voltage, or abnormal lighting of LEDs at low current.
- 8) The thermal management is one of the most critical factors for the LED lighting system. Especially the LED junction temperature should not exceed the absolute maximum rating while operation of LED lighting system.  
For more information, please refer to Application Note 'Mechanical & Thermal Guide for COB'.
- 9) In case of driving LEDs around the minimum current level ( $I_{f\_min}$ ), chips might exhibit different brightness due to the variation in I-V characteristics of each one. This is normal and does not adversely affect the performance of product.
- 10) VOCs (Volatile Organic Compounds) can be generated from adhesives, flux, hardener or organic additives used in luminaires (fixtures). Transparent LED silicone encapsulant is permeable to those chemicals and they may lead to a discoloration of encapsulant when they exposed to heat or light. This phenomenon can cause a significant loss of light emitted (output) from the luminaires. In order to prevent these problems, we recommend users to know the physical properties of materials used in luminaires and they must be carefully selected.
- 11) The resin area is very sensitive, please do not handle, press, touch, rub, clean, or pick by with tweezers on it. Instead, please pick at the handling area as indicated below.

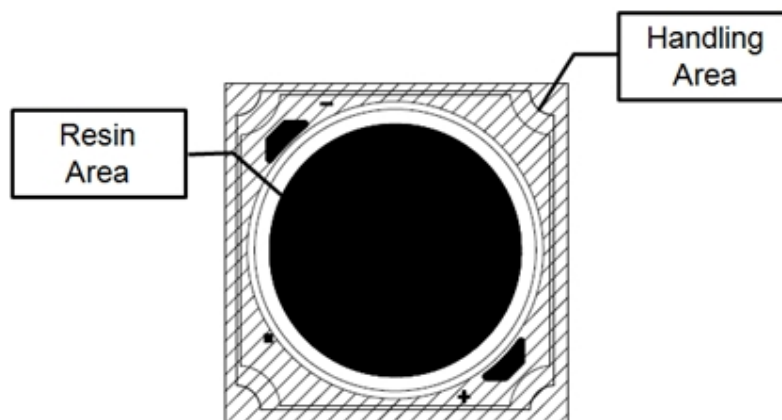

# Legal and additional information.

## [About Samsung Electronics Co., Ltd.](#)

Samsung Electronics Co., Ltd. inspires the world and shapes the future with transformative ideas and technologies, redefining the worlds of TVs, smartphones, wearable devices, tablets, cameras, digital appliances, printers, medical equipment, network systems and semiconductors.

We are also leading in the Internet of Things space through, among others, our Digital Health and Smart Home initiatives. We employ 307,000 people across 84 countries. To discover more, please visit our official website at [www.samsung.com](http://www.samsung.com) and our official blog at [global.samsungtomorrow.com](http://global.samsungtomorrow.com).

Copyright © 2015 Samsung Electronics Co., Ltd. All rights reserved.

Samsung is a registered trademark of Samsung Electronics Co., Ltd.

Specifications and designs are subject to change without notice. Non-metric weights and measurements are approximate. All data were deemed correct at time of creation. Samsung is not liable for errors or omissions. All brand, product, service names and logos are trademarks and/or registered trademarks of their respective owners and are hereby recognized and acknowledged.

Samsung Electronics Co., Ltd.

95, Samsung 2-ro

Giheung-gu

Yongin-si, Gyeonggi-do, 446-711

KOREA

[www.samsungled.com](http://www.samsungled.com)

**SAMSUNG**